

























Dětský psací stůl ANIMALS TYP 1 B01

NÁVOD K MONTÁŽI

Příslušenství / Fittings						
 K1	 M2	 M1	 ZM1	 ZW1	 T2	 G1
34 ks / pcs	40 ks / pcs	40 ks / pcs	40 ks / pcs	28 ks / pcs	30 ks / pcs	20 ks / pcs
 W1	 B1	 W4	 W6	 U1	 U2	 N1
Ø3 x 16 72 ks / pcs	4 ks / pcs	Ø4 x 16 40 ks / pcs	Ø6.3 x 50 28 ks / pcs	6 ks / pcs	12 ks / pcs	8 ks / pcs
 P1-A	 P1-B	 P2-A	 P2-B	 Z1-A	 Z1-B	
500 mm 5 ks / pcs	500 mm 5 ks / pcs	500 mm 5 ks / pcs	500 mm 5 ks / pcs	2 ks / pcs	2 ks / pcs	
 P5-A	 P5-B	 P6-A	 P5-B			
300 mm 1 ks / pcs	300 mm 1 ks / pcs	300 mm 1 ks / pcs	300 mm 1 ks / pcs			

Nástroje / Tools		
		

MONTÁŽ STOLU JE MOŽNÁ POUZE VE DVOU OSOBÁCH

**VELMI DŮLEŽITÉ!
ČTĚTE PEČLIVĚ
NÁVOD SI ULOŽTE PRO POZDĚJŠÍ POUŽITÍ
UŽIVATELSKÁ PŘÍRUČKA**

1.
Všecky obalový materiál odstraňte mimo dosah dětí, tak aby nemohlo dojít k udušení nebo uškrcení.
2.
Všechny spoje musí být řádně dotaženy, žádná součástka nesmí zůstat volná.
3.
Nábytek nepoužívejte v případě, že je nějaká součástka poškozená, či chybí.
4.
Používejte pouze součástky dodané výrobcem.
5.
Nepokládejte nábytek do blízkosti otevřeného ohně nebo k jiným zdrojům tepla, jako je elektrické nebo plynové topení apod., mohlo by dojít ke vznícení.

**VERY IMPORTANT!
PLEASE READ CAREFULLY
SAVE FOR FUTURE USE**

USER'S MANUAL

1.
To avoid the danger of choking or strangulation keep the package with fittings away from babies and children.
2.
All connections must be tightened properly and no coupled element can not be loose.
3.
Do not use the bed when, if any of the elements is damaged or if there is any element missing.
4.
Use only the elements given by manufacturer.
5.
Do not place the bed near naked flames or other heat sources such as electric or gas radiators etc., this may cause a fire.

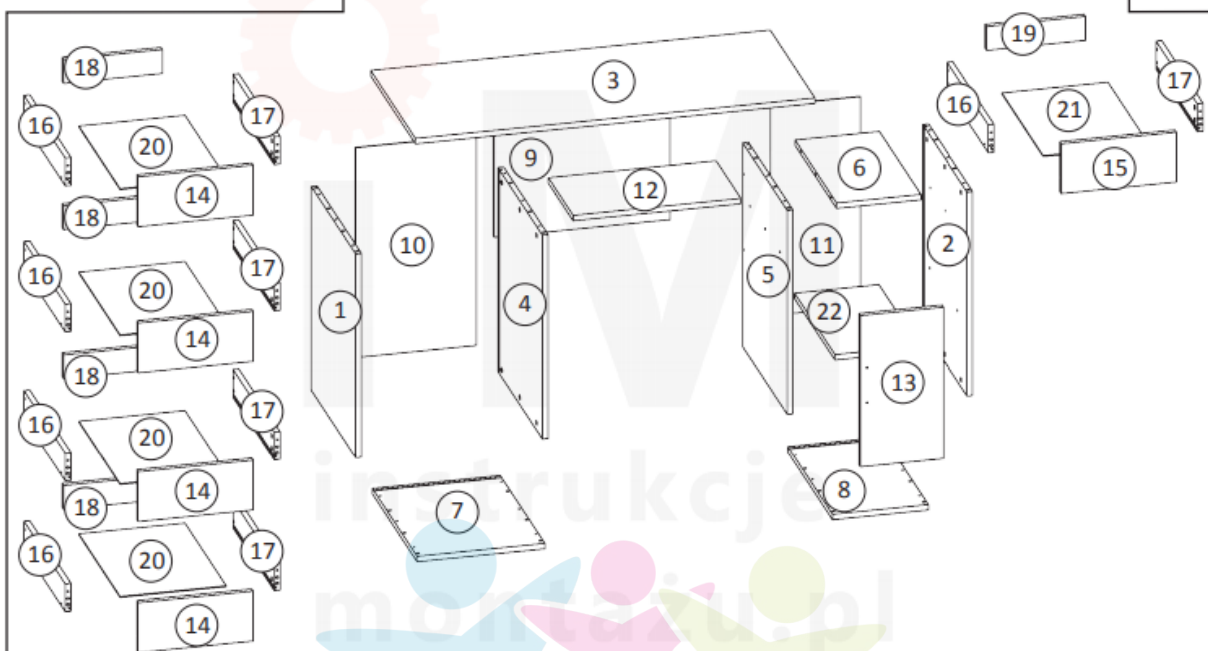

Balení 1 z 1 / Package 1 of 1

Číslo položky / item no.	Rozměry (mm) / Dimensions (mm)	Počet / Quantity
1	674 x 598 x 18	1
2	674 x 598 x 18	1
3	1252 x 600 x 18	1
4	674 x 598 x 18	1
5	674 x 598 x 18	1
6	264 x 565 x 18	1
7	402 x 600 x 18	1
8	302 x 600 x 18	1
9	550 x 450 x 18	1
10	382 x 692 x 3	1
11	282 x 692 x 3	1

12	525 x 300 x 18	1
13	260 x 504 x 18	1
14	360 x 166 x 18	4
15	260 x 166 x 18	1
16	500 x 124 x 18	5
17	500 x 124 x 18	5
18	303 x 106 x 18	4
19	203 x 106 x 18	1
20	321 x 504 x 3	4
21	221 x 504 x 3	1
22	264 x 565 x 18	1

Před montáží se ujistěte, že balení obsahuje všechny položky uvedené na této stránce a zkontrolujte, jestli žádná z položek není poškozena. V případě, že některá z položek chybí nebo jeví známky poškození, kontaktujte prodejce tohoto výrobku.

BEFORE ASSEMBLING THE FURNITURE PLEASE CHECK THAT PACKAGES INCLUDE ALL ITEMS LISTED IN THE TABLE ON PAGE NO 3, AND WHETHER THESE ITEMS ARE NOT DAMAGED !!!
IF MISSING PARTS OR SOME OF THEM ARE DAMAGED, PLEASE CONTACT OUR CUSTOMER SERVICE OFFICE.
DAMAGES FOUND AFTER ASSEMBLING WILL NOT BE CONSIDERED !!!

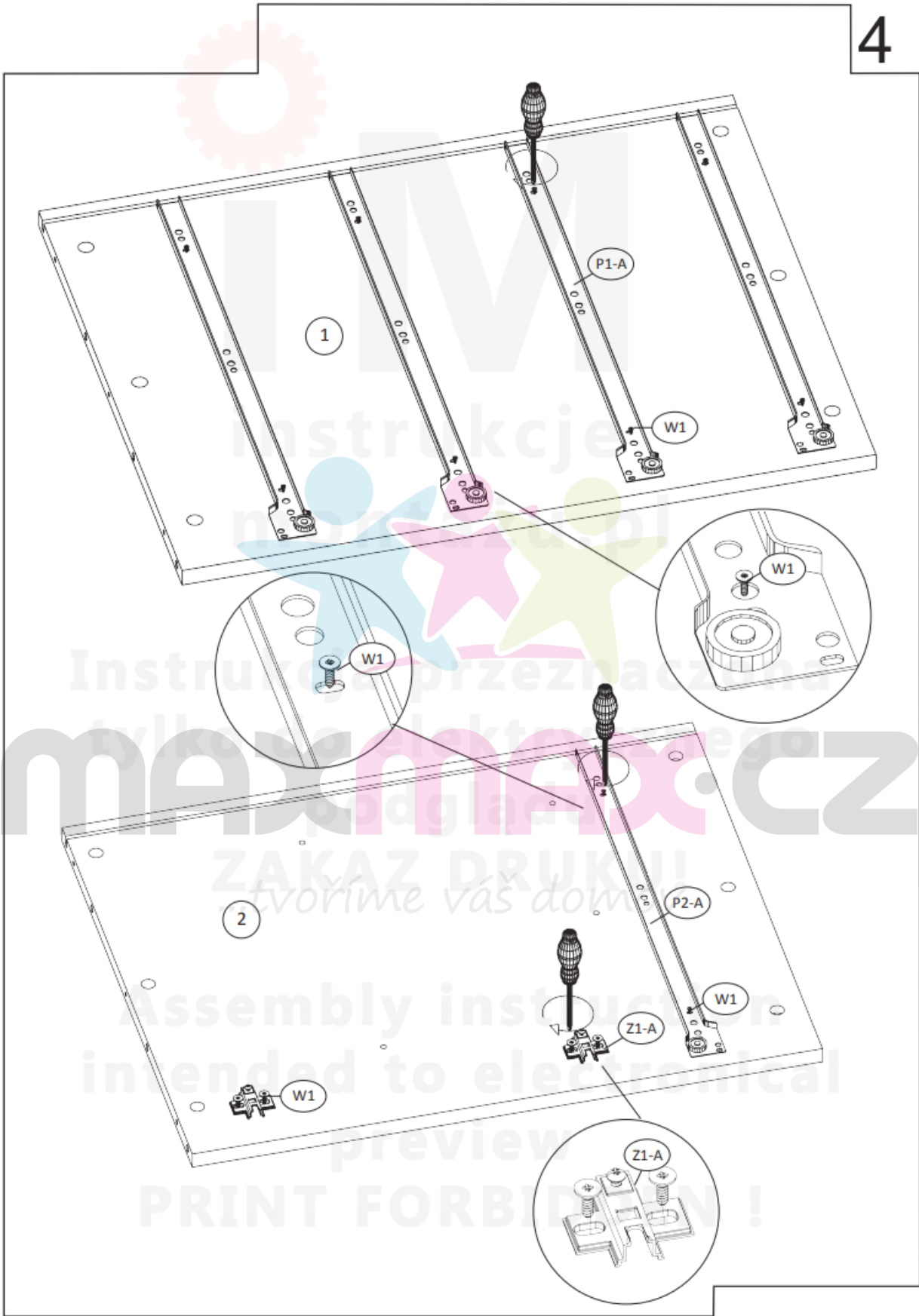

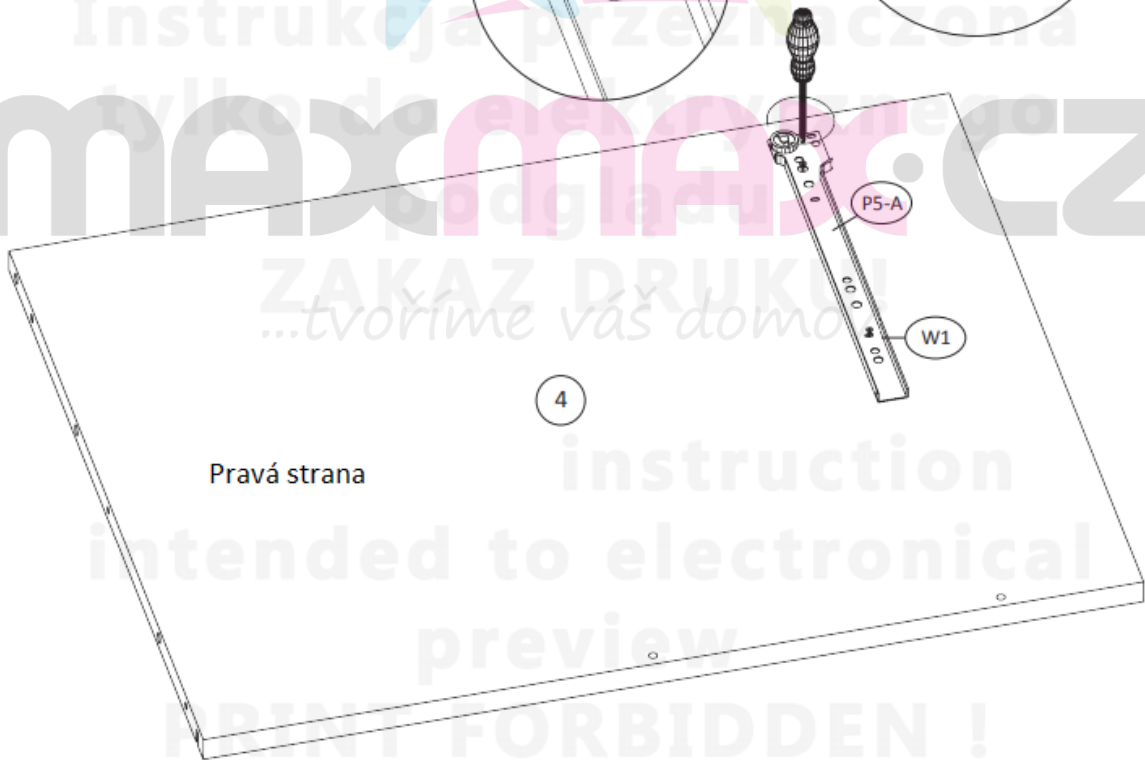
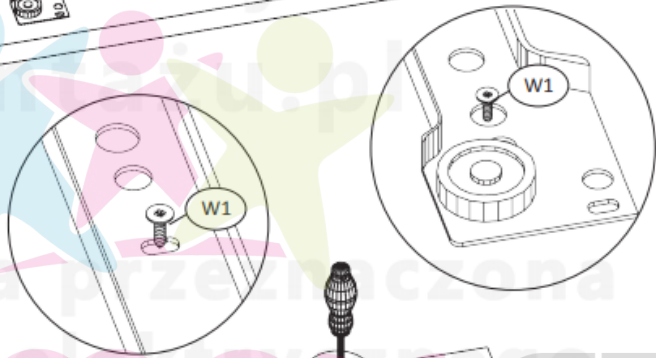
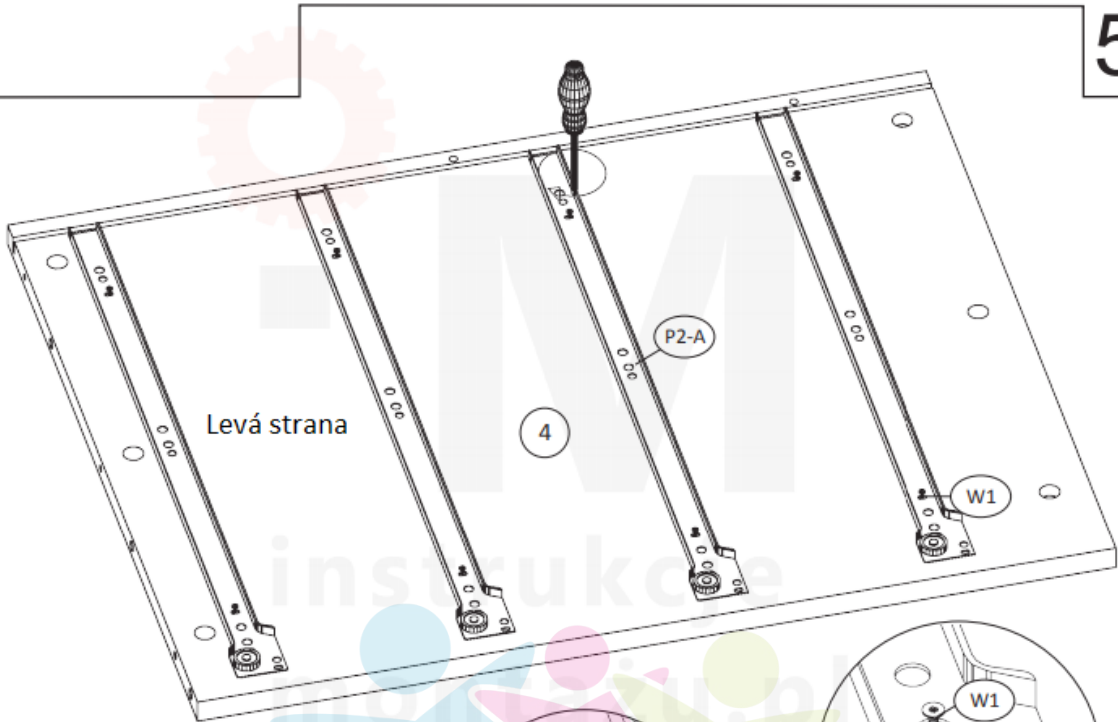

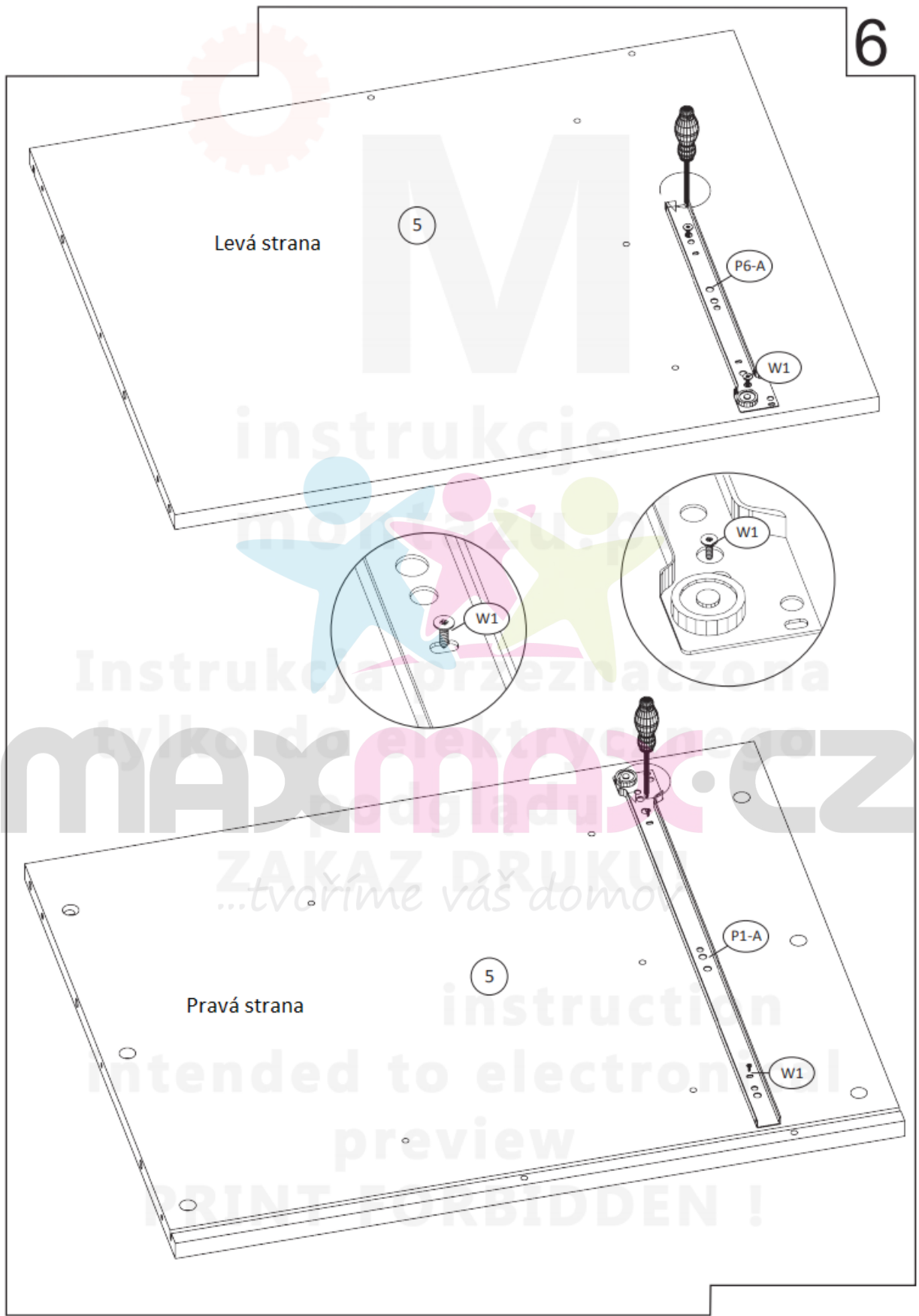

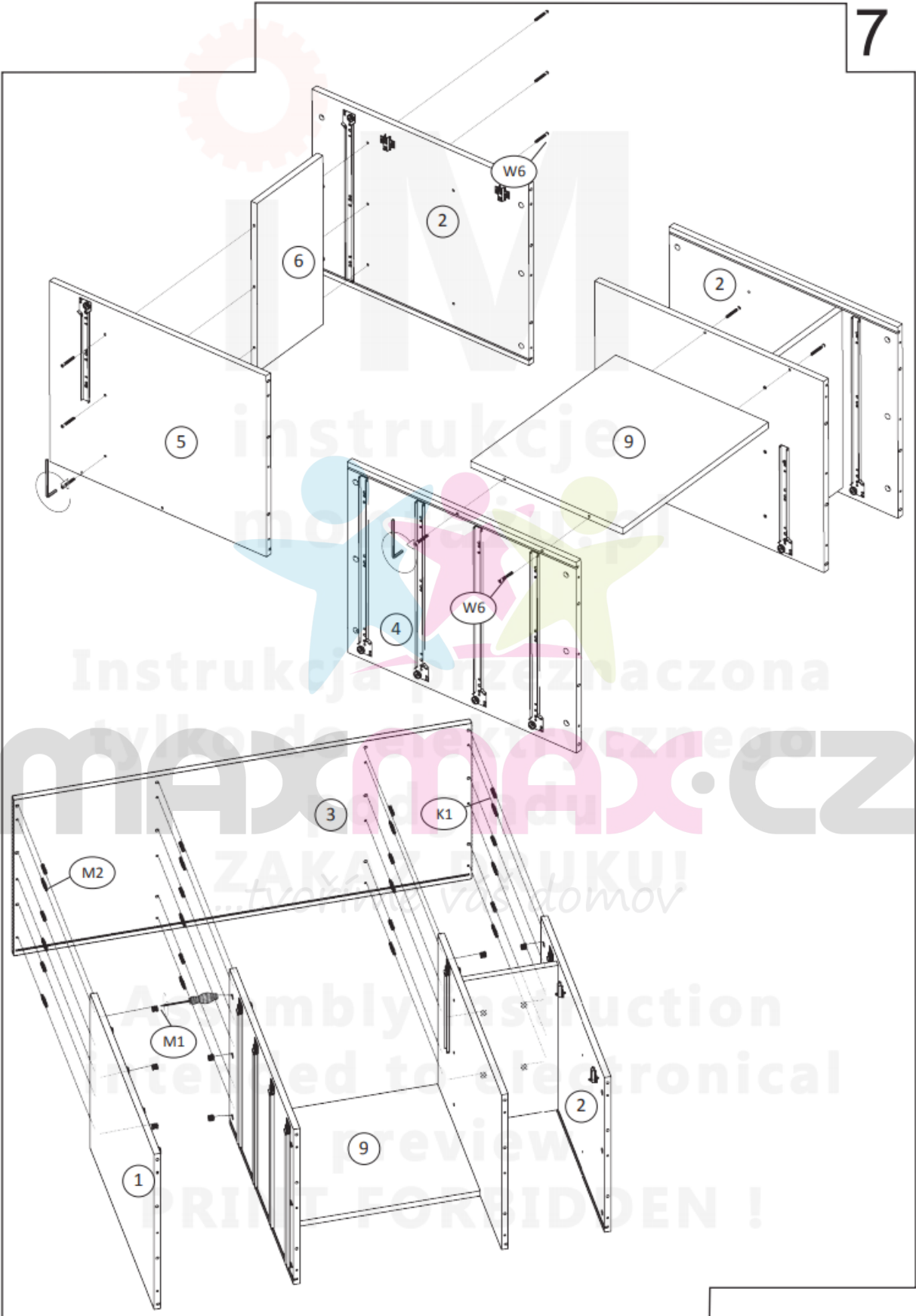

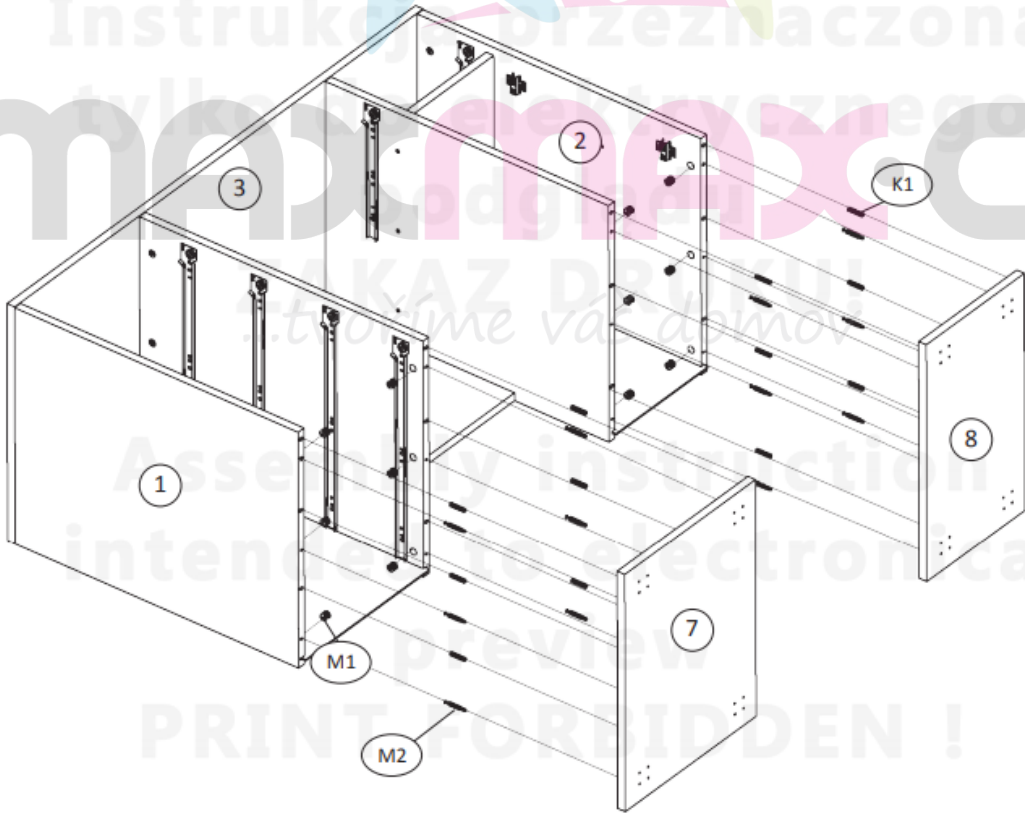
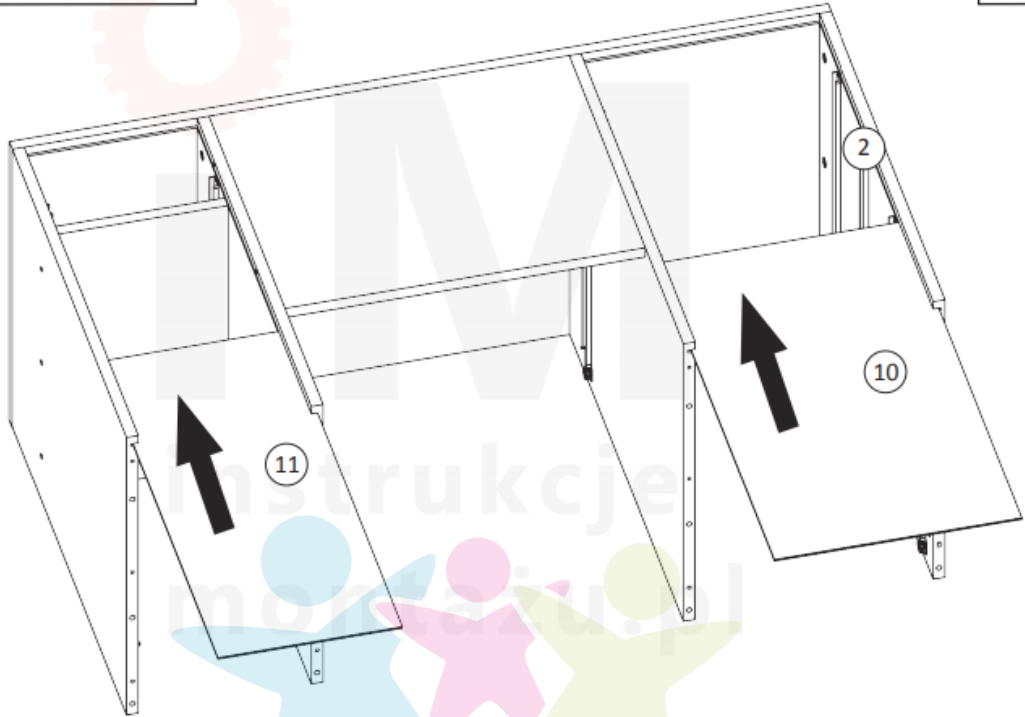

Instrukcje montażu
Instrukcja przeznaczona
tylko do użytku
mającego odgórny
WYKAZ DZIAŁU
i tożsime wartości
Assembly instruction
intended for
preview
PRINT FORBIDDEN!

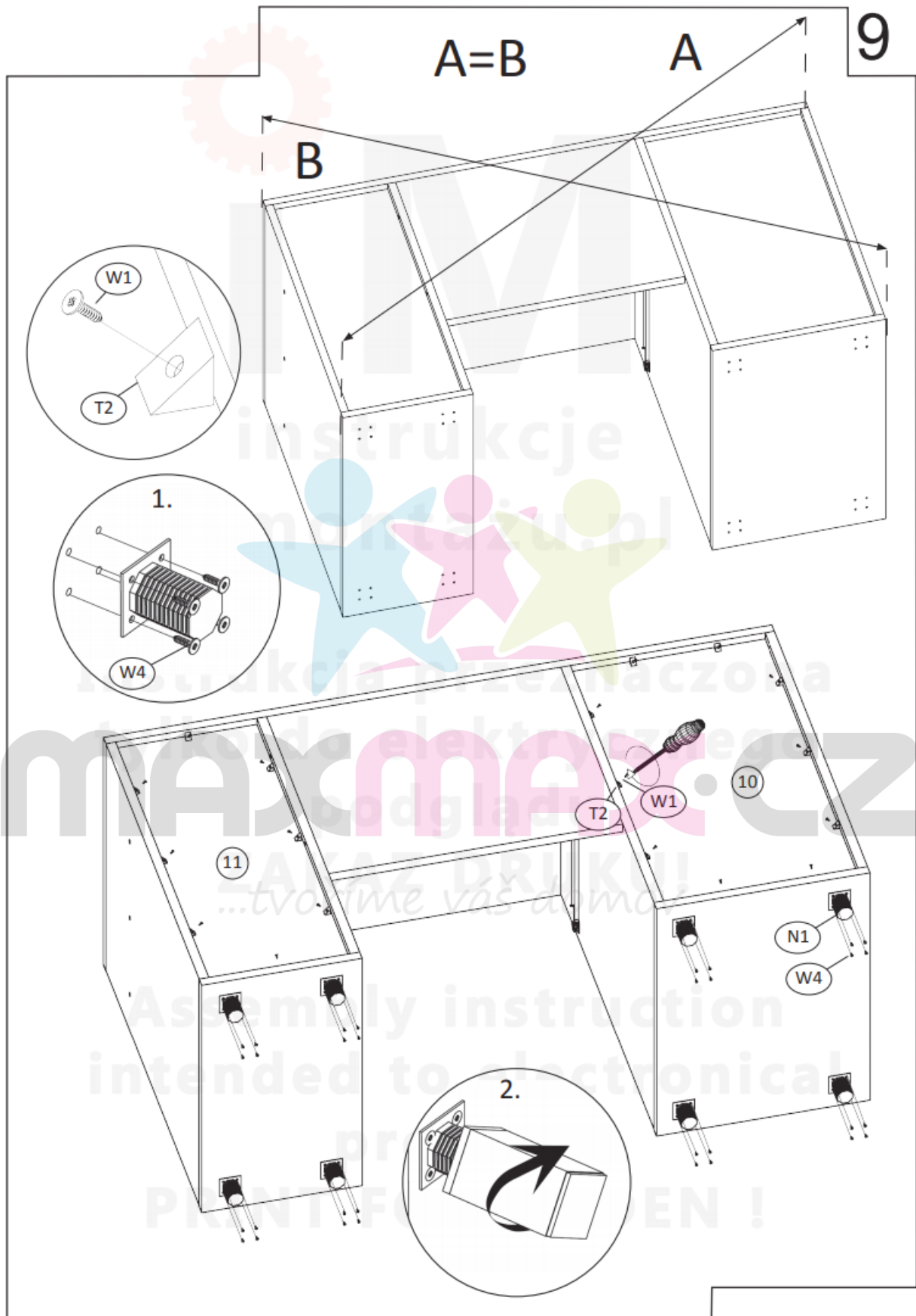

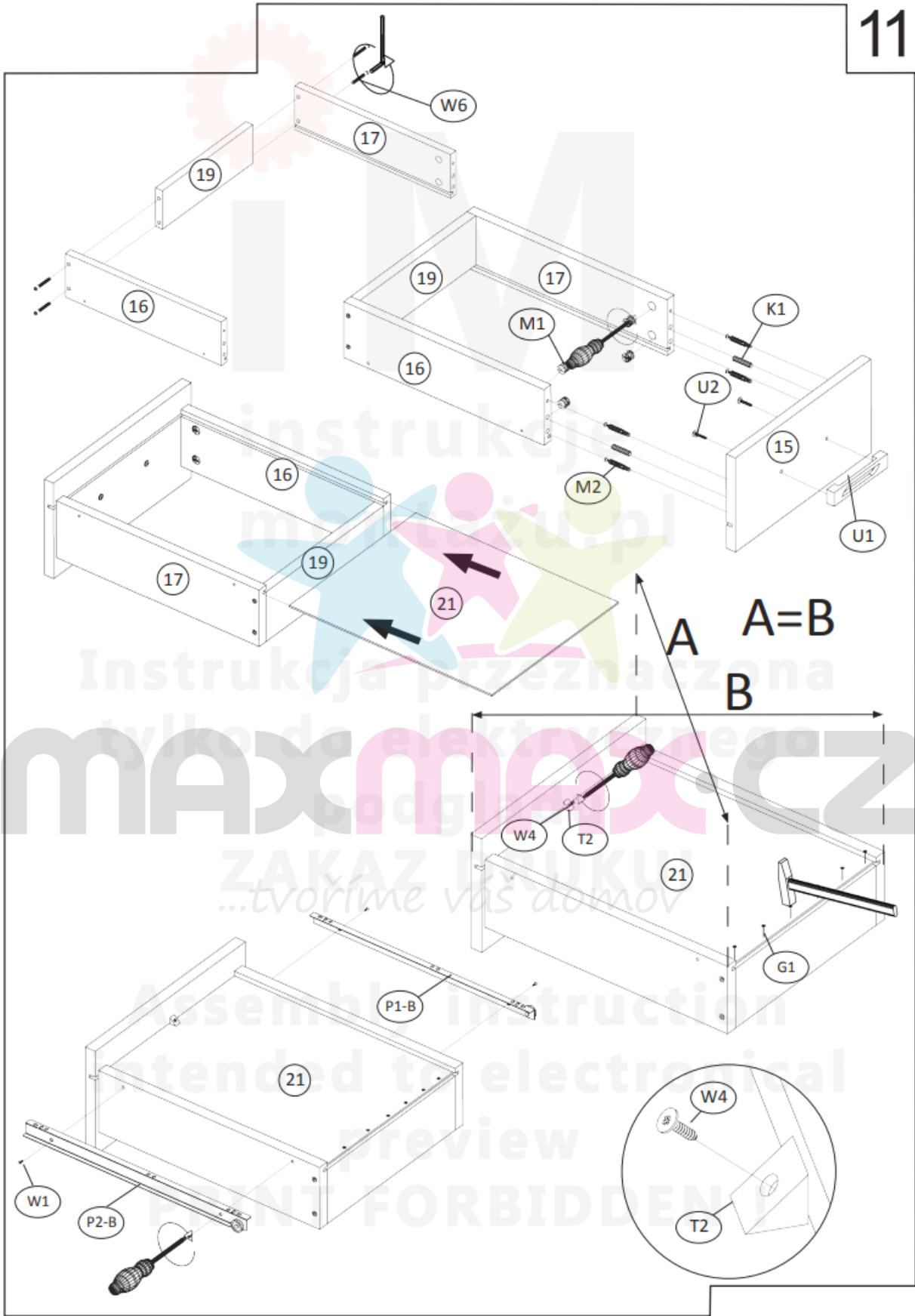

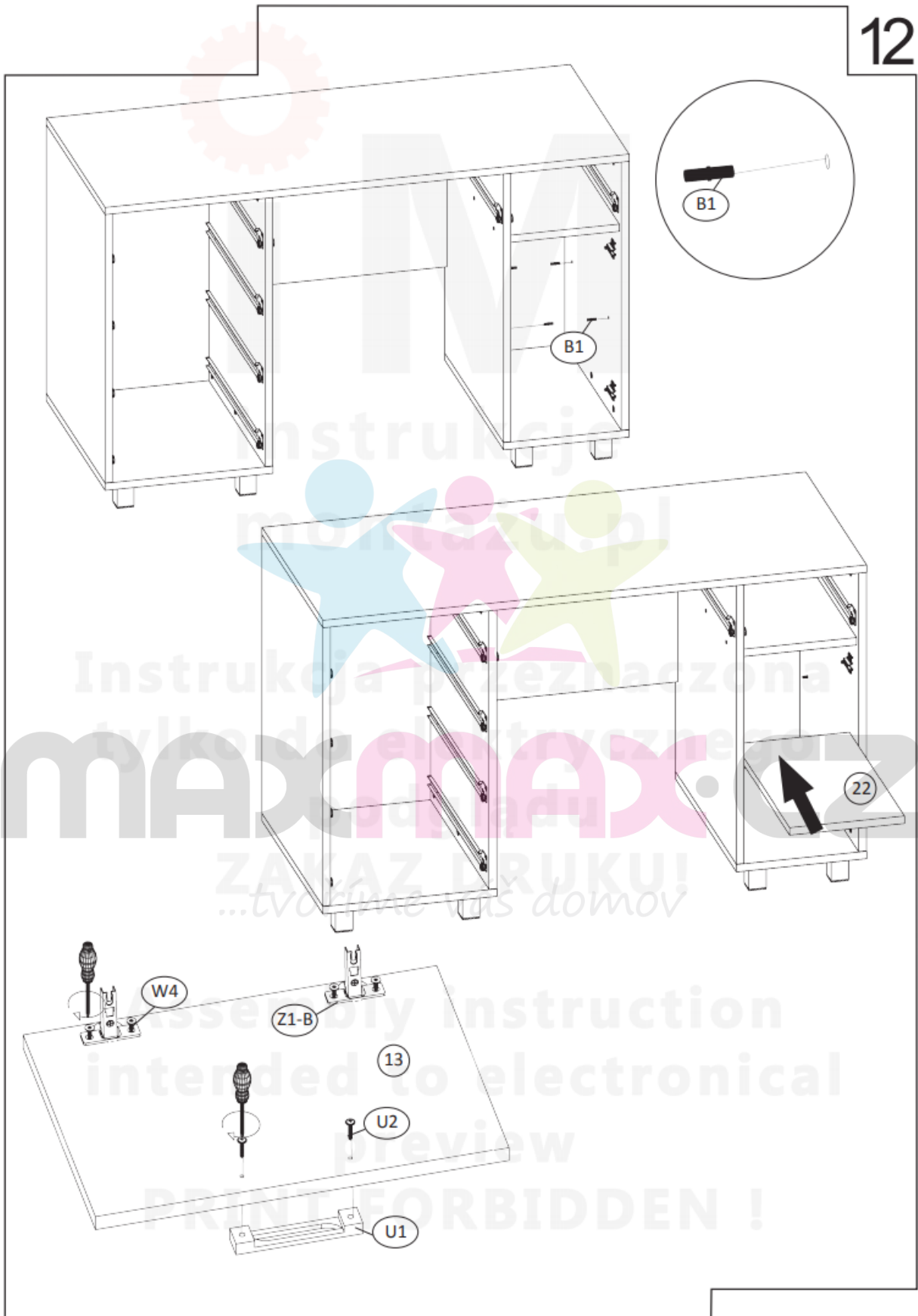

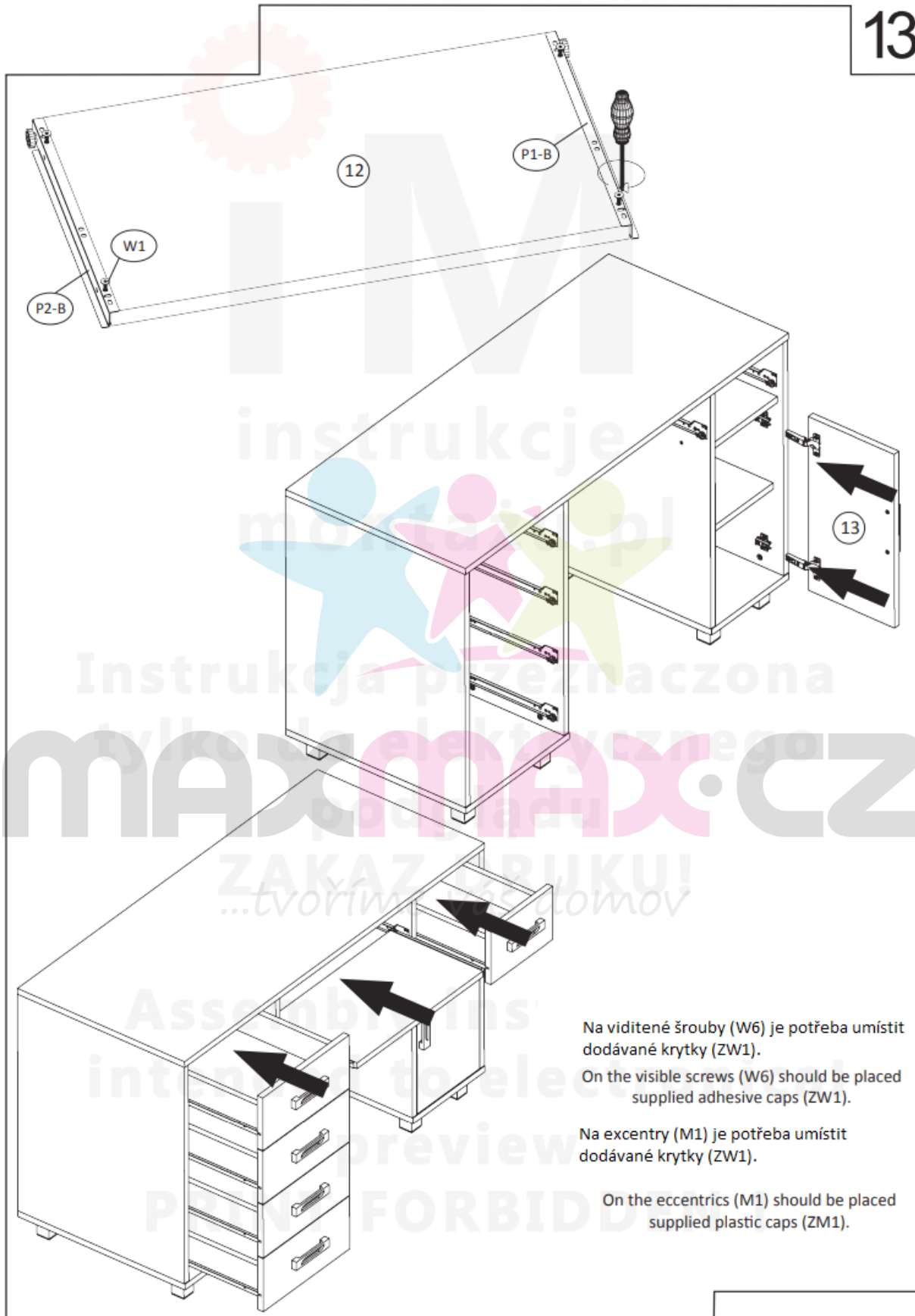

Na viditelné šrouby (W6) je potřeba umístit dodávané krytky (ZW1).

On the visible screws (W6) should be placed supplied adhesive caps (ZW1).

Na excentry (M1) je potřeba umístit dodávané krytky (ZW1).

On the eccentrics (M1) should be placed supplied plastic caps (ZW1).

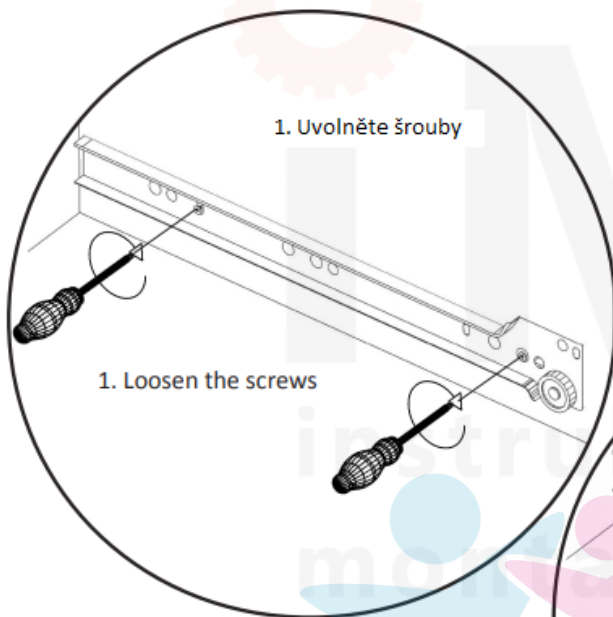

1. Uvolněte šrouby

1. Loosen the screws

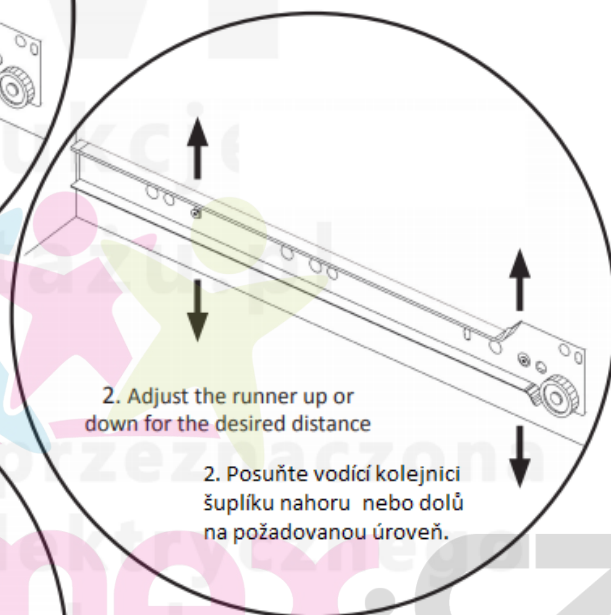

2. Adjust the runner up or down for the desired distance

2. Posuňte vodící kolejnici šuplíku nahoru nebo dolů na požadovanou úroveň.

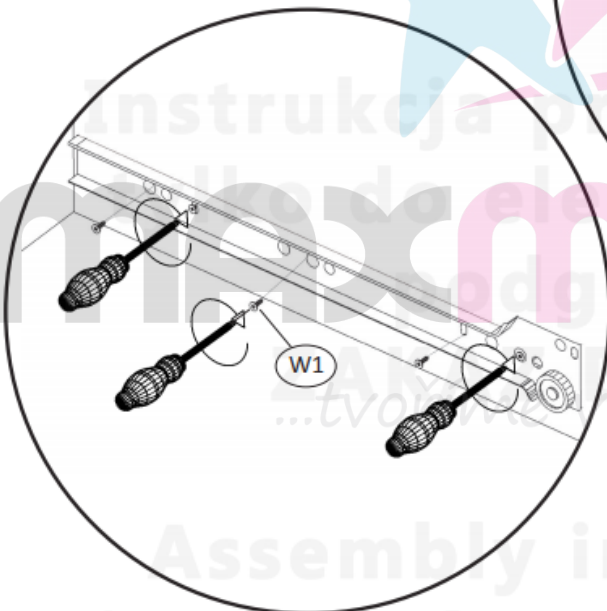

3. Tighten the screws loosened earlier.

3. Utáhněte dříve uvolněné šrouby.

4. Zasuňte zásuvku a zkontrolujte její polohu.

5. Pokud je zásuvka správně umístěna, zašroubujte další tři šrouby pro stabilizaci.

4. Slide the drawer and check their positions.

5. If the drawers are mounted properly tighten another 3 screws to stabilize each drawer runner.

**V případě potřeby opakujte jednotlivé kroky.
If necessary, repeat the steps.**

Assembly instruction

intended to electrical

previ

PRINT FORBIDDEN !