

























**Dětský psací stůl ANIMALS TYP10  
B10**

**NÁVOD K MONTÁŽI**

Příslušenství / Fittings						
 K1	 M2	 M1	 ZM1	 ZW1	 T2	 G1
21 ks / pcs	27 ks / pcs	27 ks / pcs	27 ks / pcs	16 ks / pcs	18 ks / pcs	20 ks / pcs
 W1 Ø3 x 16 / pcs	 S1	 W4 Ø4 x 16	 W6 Ø6,3 x 50	 U1	 U2	 N1
16 szt. / pcs	2 szt. / pcs	16 szt. / pcs	16 szt. / pcs	4 szt. / pcs	16 szt. / pcs	4 szt. / pcs
 P1-A 500 mm 3 szt. / pcs	 P1-B 500 mm 3 szt. / pcs	 P2-A 500 mm 3 szt. / pcs	 P2-B 500 mm 3 szt. / pcs	 P5-B 300 mm 1 szt. / pcs	 P6-A 300 mm 1 szt. / pcs	 P5-B 300 mm 1 szt. / pcs
 P5-A 300 mm 1 szt. / pcs						

**Nástroje / Tools**

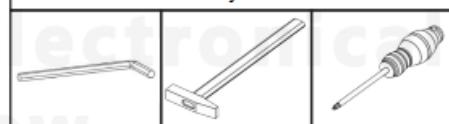

**MONTÁŽ STOLU JE MOŽNÁ POUZE VE DVOU OSOBÁCH**

**VELMI DŮLEŽITÉ!  
ČTĚTE PEČLIVĚ  
NÁVOD SI ULOŽTE PRO POZDĚJŠÍ POUŽITÍ  
UŽIVATELSKÁ PŘÍRUČKA**

1.  
Všecky obalový materiál odstraňte mimo dosah dětí, tak aby nemohlo dojít k udušení nebo uškrcení.
2.  
Všechny spoje musí být řádně dotaženy, žádná součástka nesmí zůstat volná.
3.  
Nábytek nepoužívejte v případě, že je nějaká součástka poškozená, či chybí.
4.  
Používejte pouze součástky dodané výrobcem.
5.  
Nepokládejte nábytek do blízkosti otevřeného ohně nebo k jiným zdrojům tepla, jako je elektrické nebo plynové topení apod., mohlo by dojít ke vznícení.

**VERY IMPORTANT!  
PLEASE READ CAREFULLY  
SAVE FOR FUTURE USE**

**USER'S MANUAL**

1.  
To avoid the danger of choking or strangulation keep the package with fittings away from babies and children.
2.  
All connections must be tightened properly and no coupled element can not be loose.
3.  
Do not use the bed when, if any of the elements is damaged or if there is any element missing.
4.  
Use only the elements given by manufacturer.
5.  
Do not place the bed near naked flames or other heat sources such as electric or gas radiators etc., this may cause a fire.

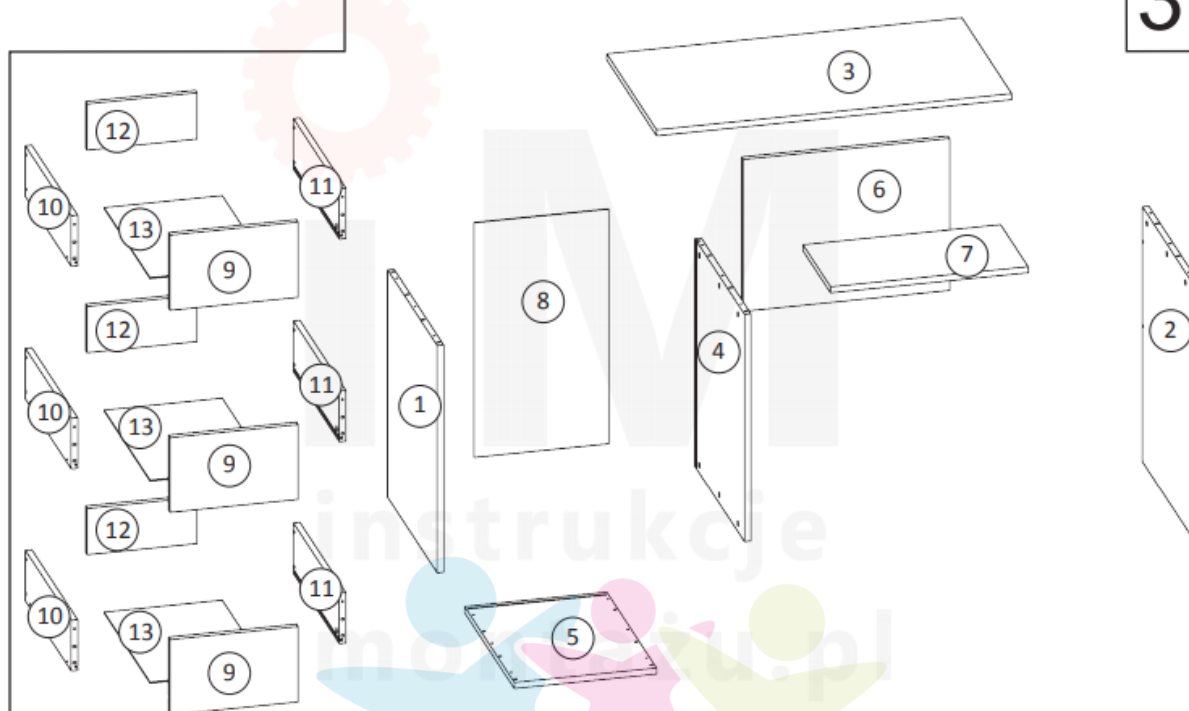

#### Balení 1 z 1 / Package 1 of 1

Číslo položky / item no.	Rozměry (mm) / Dimensions (mm)	Počet / Quantity
1	674 x 598 x 18	1
2	752 x 598 x 18	1
3	1002 x 600 x 18	1
4	674 x 598 x 18	1
5	402 x 600 x 18	1
6	582 x 450 x 18	1
7	557 x 300 x 18	1
8	382 x 692 x 3	1
9	360 x 223 x 18	1
10	500 x 180 x 18	1
11	500 x 180 x 18	1
12	303 x 162 x 18	1
13	321 x 504 x 3	1

Před montáží se ujistěte, že balení obsahuje všechny položky uvedené na této stránce a zkontrolujte, jestli žádná z položek není poškozena. V případě, že některá z položek chybí nebo jeví známky poškození, kontaktujte prodejce tohoto výrobku.

BEFORE ASSEMBLING THE FURNITURE PLEASE CHECK THAT PACKAGES INCLUDE ALL ITEMS LISTED IN THE TABLE ON PAGE NO 3, AND WHETHER THESE ITEMS ARE NOT DAMAGED !!!

IF MISSING PARTS OR SOME OF THEM ARE DAMAGED, PLEASE CONTACT OUR CUSTOMER SERVICE OFFICE. DAMAGES FOUND AFTER ASSEMBLING WILL NOT BE CONSIDERED !!!

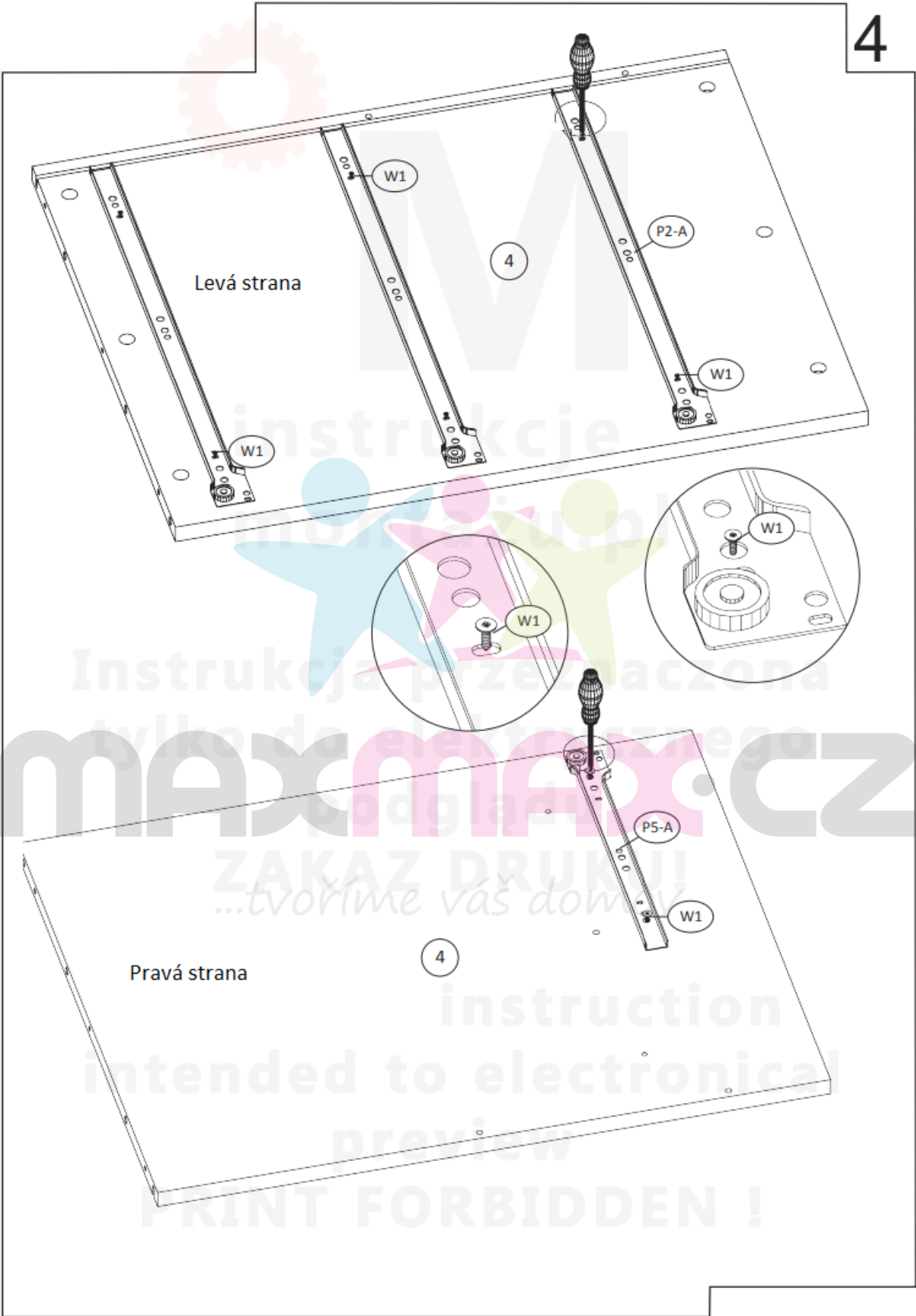

Levá strana

4

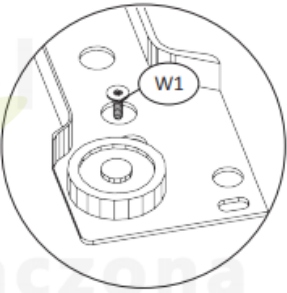
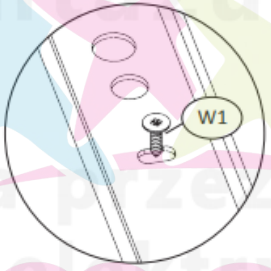

Pravá strana

4



Instrukcja przeznaczona tylko do elektronicznego podglądu  
MAX  
ZAKAZ DRUKU!  
...tvoríme váš domov!  
instruction intended to be used for electronic preview  
PRINT FORBIDDEN!

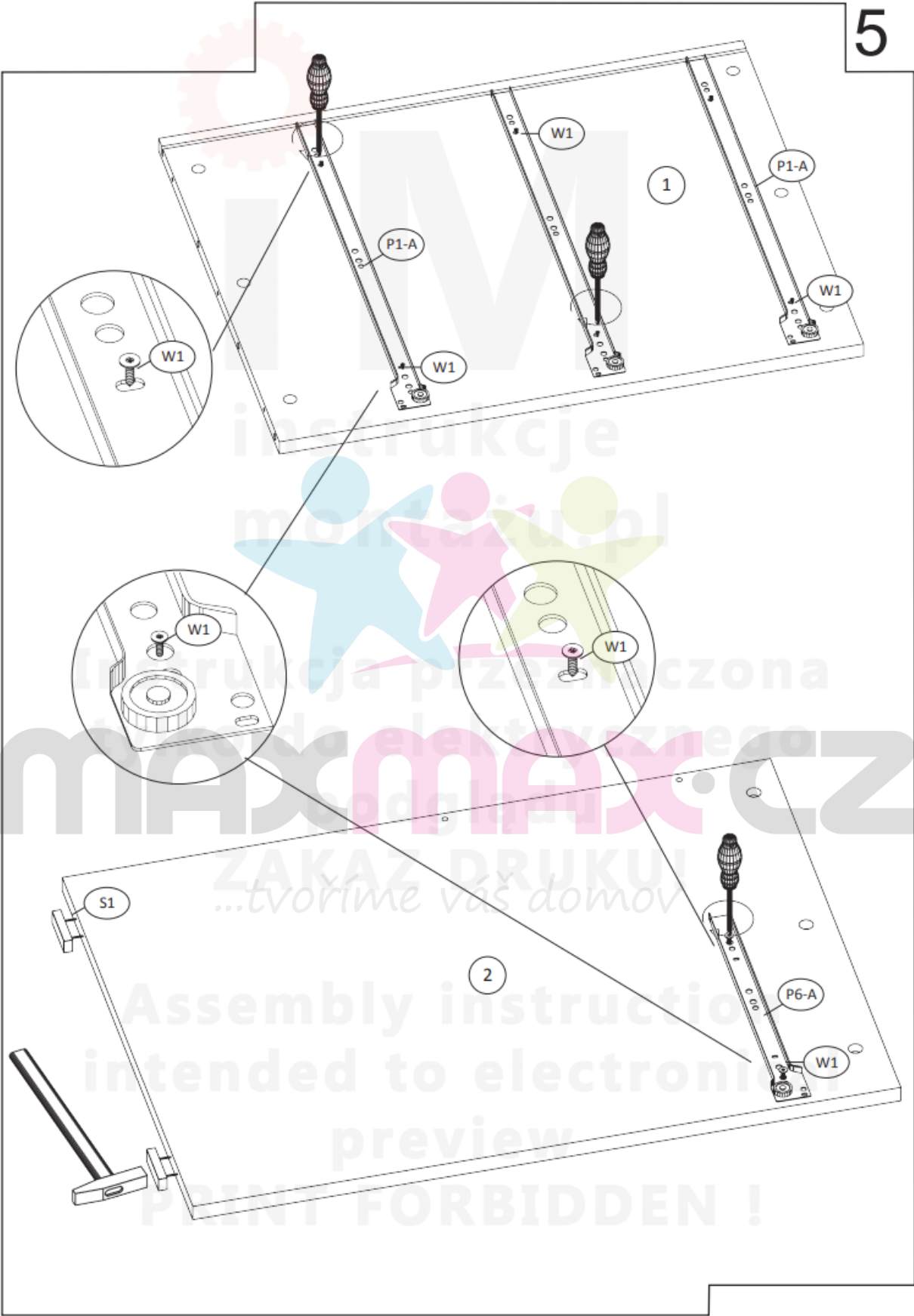

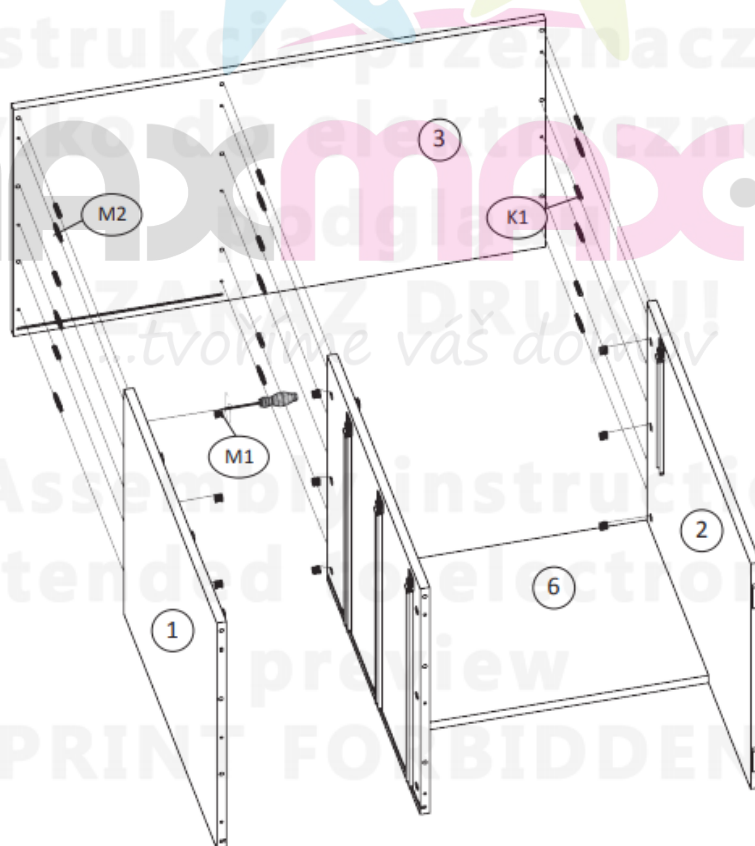
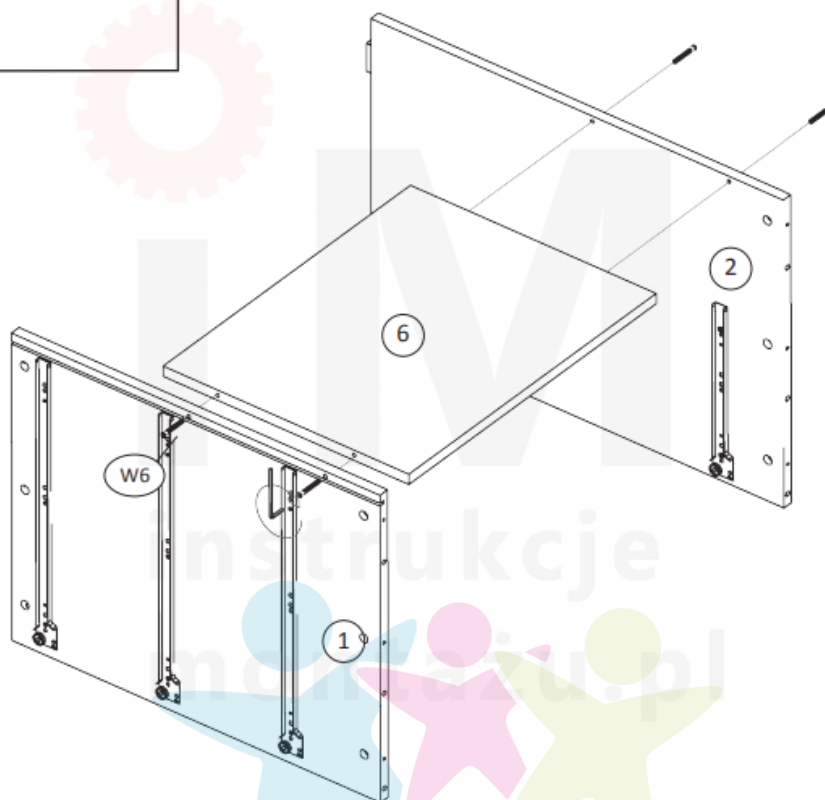

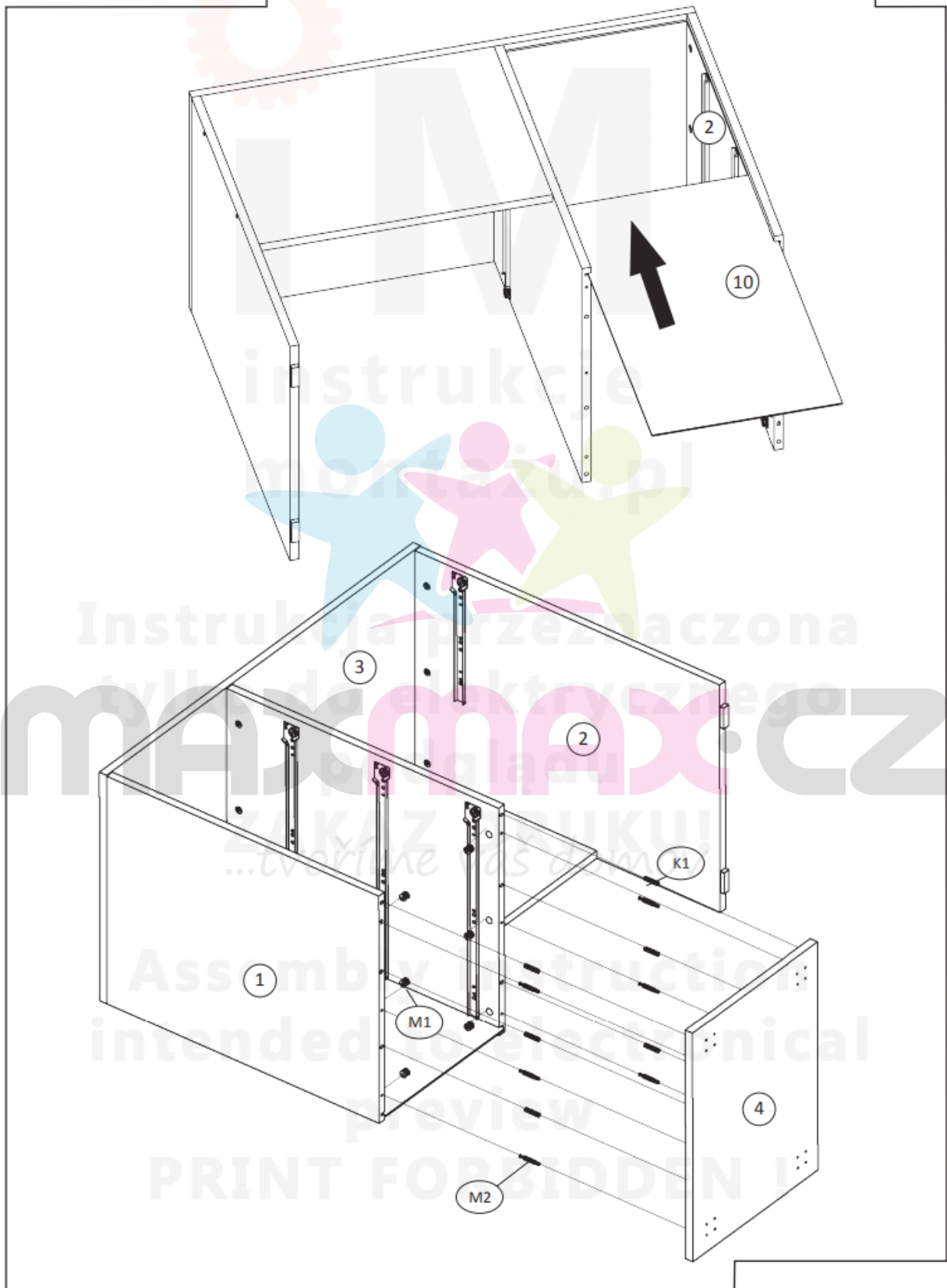



A=B

B

A

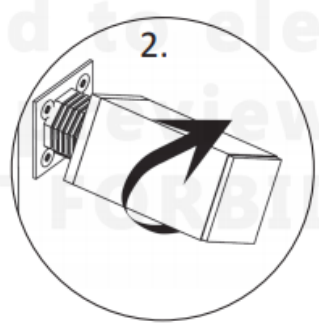
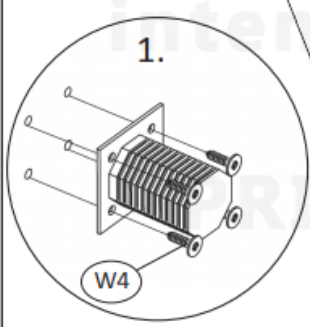
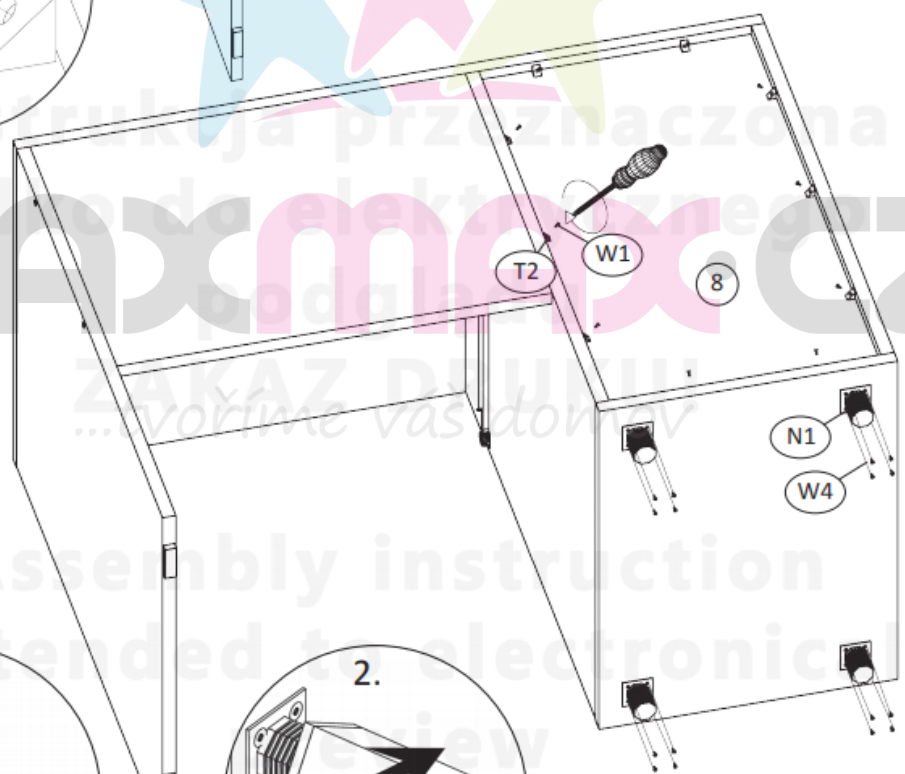
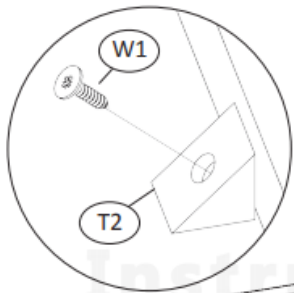

instrukcje montażowe  
Instrukcja przeznaczona tylko do elektronicznego podłączenia  
ZAKAZ Drukarni  
...voříme váš domov  
Assembly instruction intended for electronic connection  
PRINT FORBIDDEN!



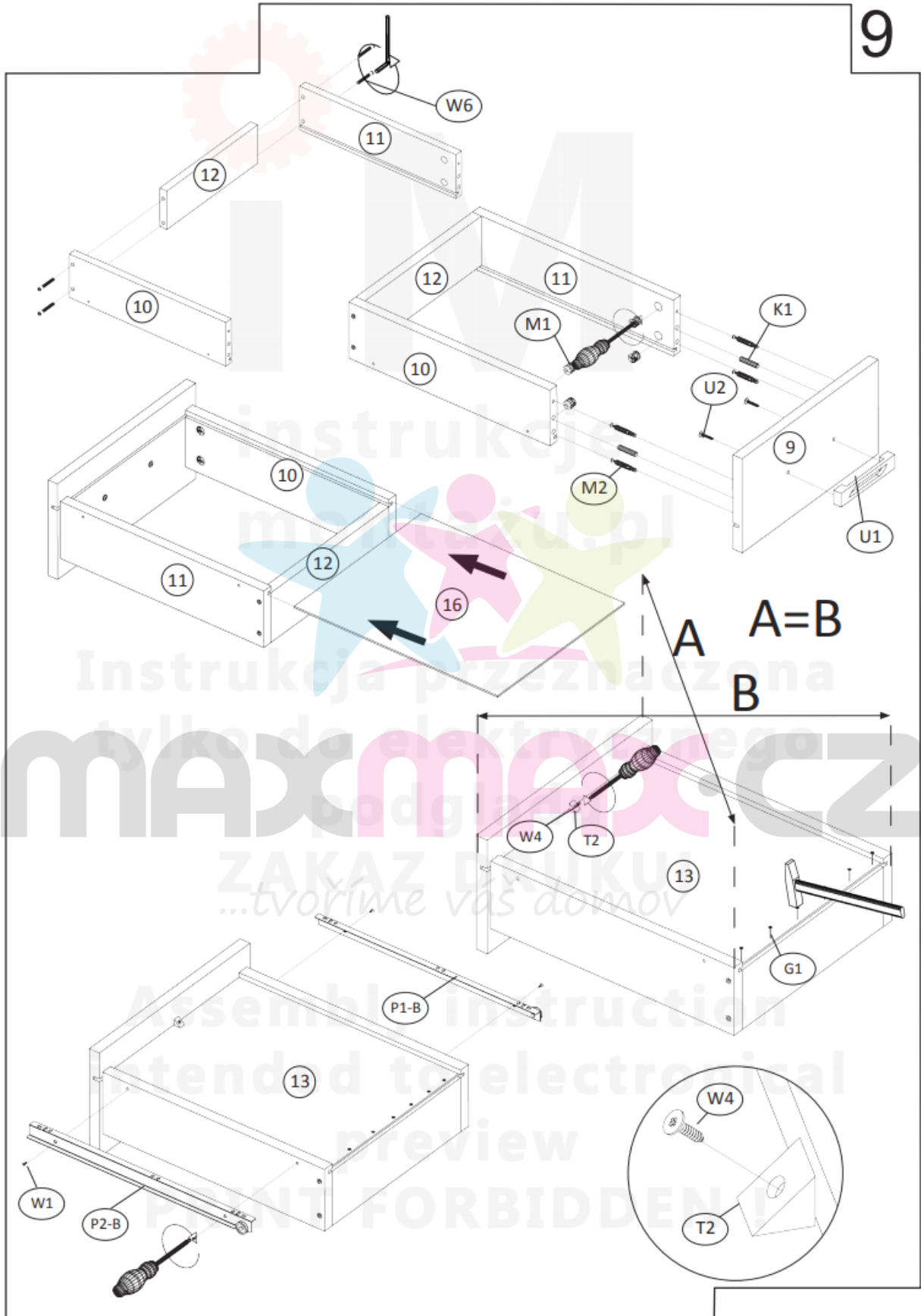

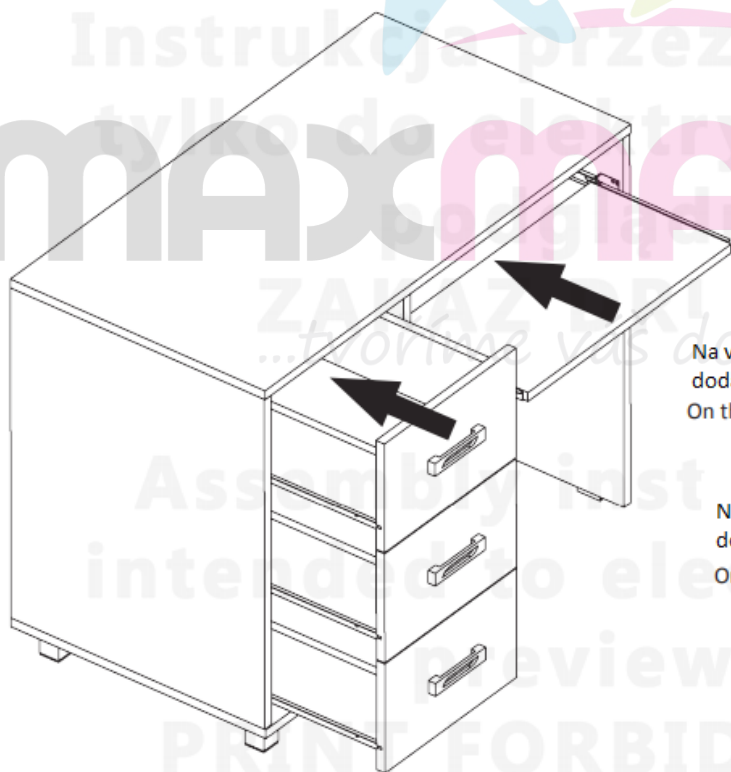
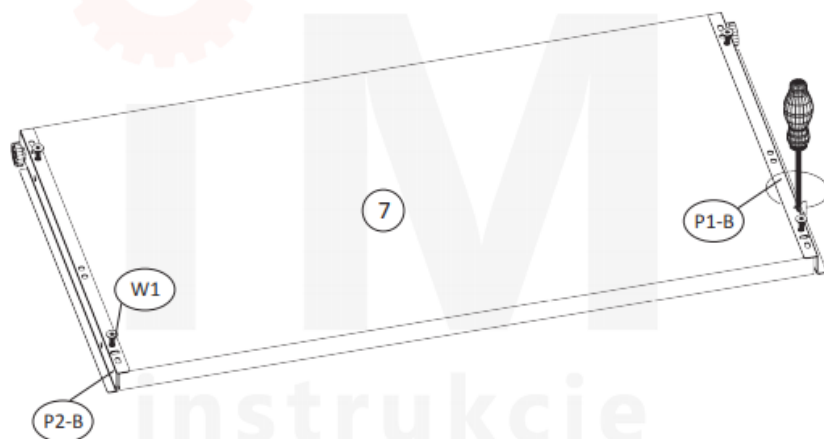

Na viditelné šrouby (W6) je potřeba umístit  
dodávané krytky (ZW1).

On the visible screws (W6) should be placed  
supplied adhesive caps (ZW1).

Na excentry (M1) je potřeba umístit  
dodávané krytky (ZM1).

On the eccentrics (M1) should be placed  
supplied plastic caps (ZM1).

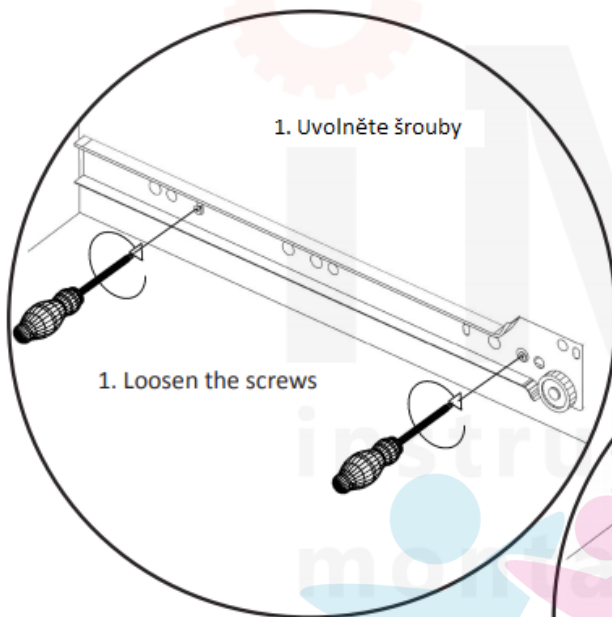

1. Uvolněte šrouby

1. Loosen the screws

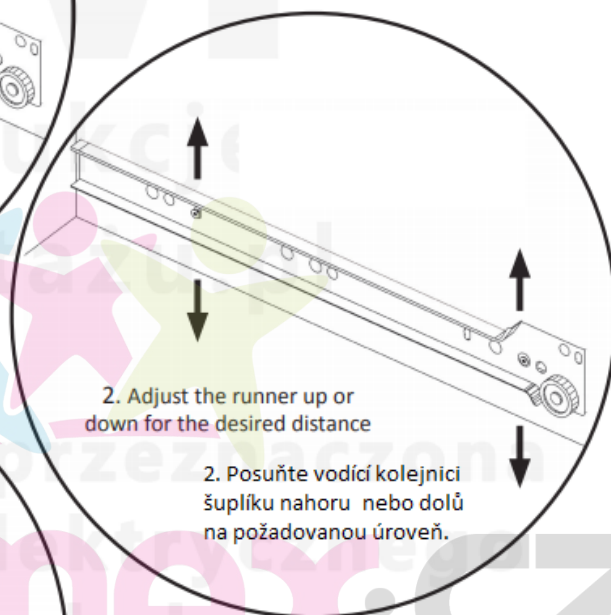

2. Adjust the runner up or down for the desired distance

2. Posuňte vodící kolejnici šuplíku nahoru nebo dolů na požadovanou úroveň.

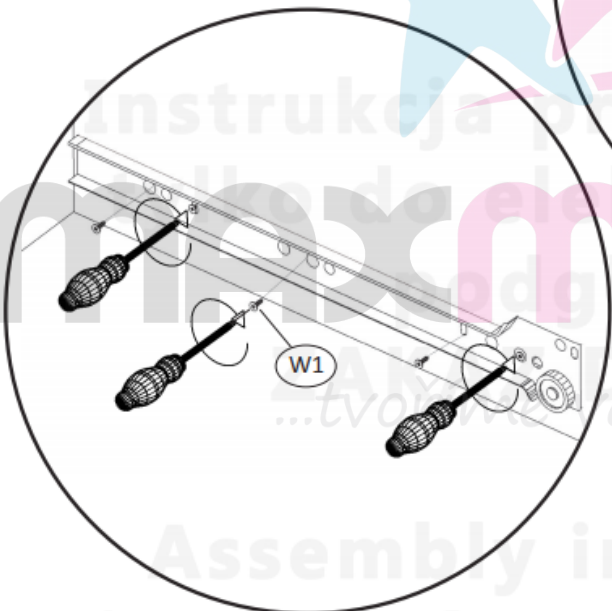

3. Tighten the screws loosened earlier.

3. Utáhněte dříve uvolněné šrouby.

4. Zasuňte zásuvku a zkontrolujte její polohu.

5. Pokud je zásuvka správně umístěna, zašroubujte další tři šrouby pro stabilizaci.

4. Slide the drawer and check their positions.

5. If the drawers are mounted properly tighten another 3 screws to stabilize each drawer runner.

**V případě potřeby opakujte jednotlivé kroky.  
If necessary, repeat the steps.**

**PRINT FORBIDDEN !**