

























## Dětská psací stůl ANIMALS TYP 11 B11

### NÁVOD K MONTÁŽI

Příslušenství / Fittings						
<b>K1</b> 	<b>M2</b> 	<b>M1</b> 	<b>ZM1</b> 	<b>ZW1</b> 	<b>T2</b> 	<b>G1</b> 
17 ks / pcs	13 ks / pcs	13 ks / pcs	13 ks / pcs	14 ks / pcs	12 ks / pcs	6 ks / pcs
<b>W1</b> 	<b>B1</b> 	<b>W4</b> 	<b>W6</b> 	<b>U1</b> 	<b>U2</b> 	<b>N1</b> 
Ø3 x 16 24 ks / pcs	6 ks / pcs	Ø4 x 16 24 ks / pcs	Ø6,3 x 50 14 ks / pcs	2 ks / pcs	4 ks / pcs	4 ks / pcs
<b>P1-A</b> 	<b>P1-B</b> 	<b>P2-A</b> 	<b>P2-B</b> 	<b>S1</b> 	<b>Z1-A</b> 	<b>Z1-B</b> 
500 mm 1 ks / pcs	500 mm 1 ks / pcs	500 mm 1 ks / pcs	500 mm 1 ks / pcs	2 ks / pcs	2 ks / pcs	2 ks / pcs
<b>P5-A</b> 	<b>P5-B</b> 	<b>P6-A</b> 	<b>P5-B</b> 			
300 mm 1 ks / pcs	300 mm 1 ks / pcs	300 mm 1 ks / pcs	300 mm 1 ks / pcs			

### Nástroje / Tools

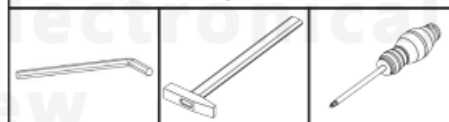

**MONTÁŽ STOLU JE MOŽNÁ POUZE VE DVOU OSOBÁCH**

**VELMI DŮLEŽITÉ!  
ČTĚTE PEČLIVĚ  
NÁVOD SI ULOŽTE PRO POZDĚJŠÍ POUŽITÍ  
UŽIVATELSKÁ PŘÍRUČKA**

1.  
Všecky obalový materiál odstraňte mimo dosah dětí, tak aby nemohlo dojít k udušení nebo uškrcení.
2.  
Všechny spoje musí být řádně dotaženy, žádná součástka nesmí zůstat volná.
3.  
Nábytek nepoužívejte v případě, že je nějaká součástka poškozená, či chybí.
4.  
Používejte pouze součástky dodané výrobcem.
5.  
Nepokládejte nábytek do blízkosti otevřeného ohně nebo k jiným zdrojům tepla, jako je elektrické nebo plynové topení apod., mohlo by dojít ke vznícení.

**VERY IMPORTANT!  
PLEASE READ CAREFULLY  
SAVE FOR FUTURE USE**

**USER'S MANUAL**

1.  
To avoid the danger of choking or strangulation keep the package with fittings away from babies and children.
2.  
All connections must be tightened properly and no coupled element can not be loose.
3.  
Do not use the bed when, if any of the elements is damaged or if there is any element missing.
4.  
Use only the elements given by manufacturer.
5.  
Do not place the bed near naked flames or other heat sources such as electric or gas radiators etc., this may cause a fire.

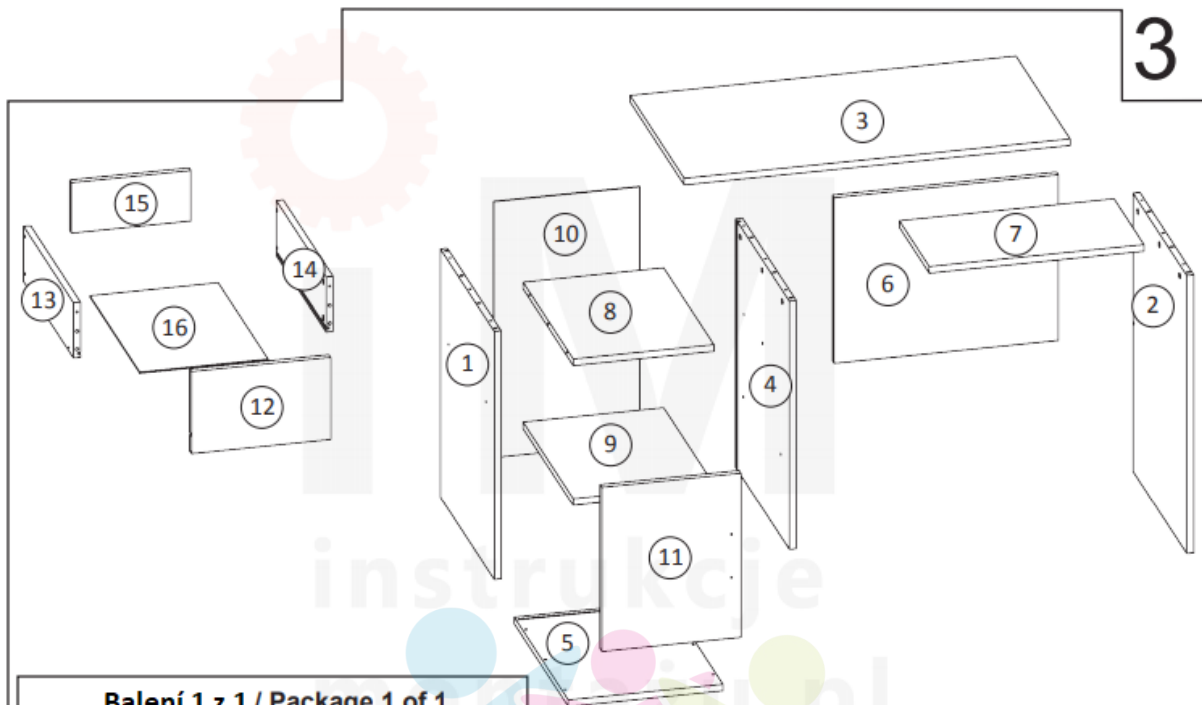

**Balení 1 z 1 / Package 1 of 1**

Číslo položky / item no.	Rozměry (mm) / Dimensions (mm)	Počet / Quantity
1	674 x 598 x 18	1
2	752 x 598 x 18	1
3	1002 x 600 x 18	1
4	674 x 598 x 18	1
5	402 x 600 x 18	1
6	582 x 450 x 18	1
7	557 x 300 x 18	1
8	364 x 565 x 18	1
9	364 x 555 x 18	1
10	382 x 692 x 3	1
11	360 x 447 x 18	1
12	360 x 223 x 18	1
13	500 x 180 x 18	1
14	500 x 180 x 18	1
15	303 x 162 x 18	1
16	321 x 504 x 3	1

Před montáží se ujistěte, že balení obsahuje všechny položky uvedené na této stránce a zkontrolujte, jestli žádná z položek není poškozena. V případě, že některá z položek chybí nebo jeví známky poškození, kontaktujte prodejce tohoto výrobku.

BEFORE ASSEMBLING THE FURNITURE PLEASE CHECK THAT PACKAGES INCLUDE ALL ITEMS LISTED IN THE TABLE ON PAGE NO 3, AND WHETHER THESE ITEMS ARE NOT DAMAGED !!!

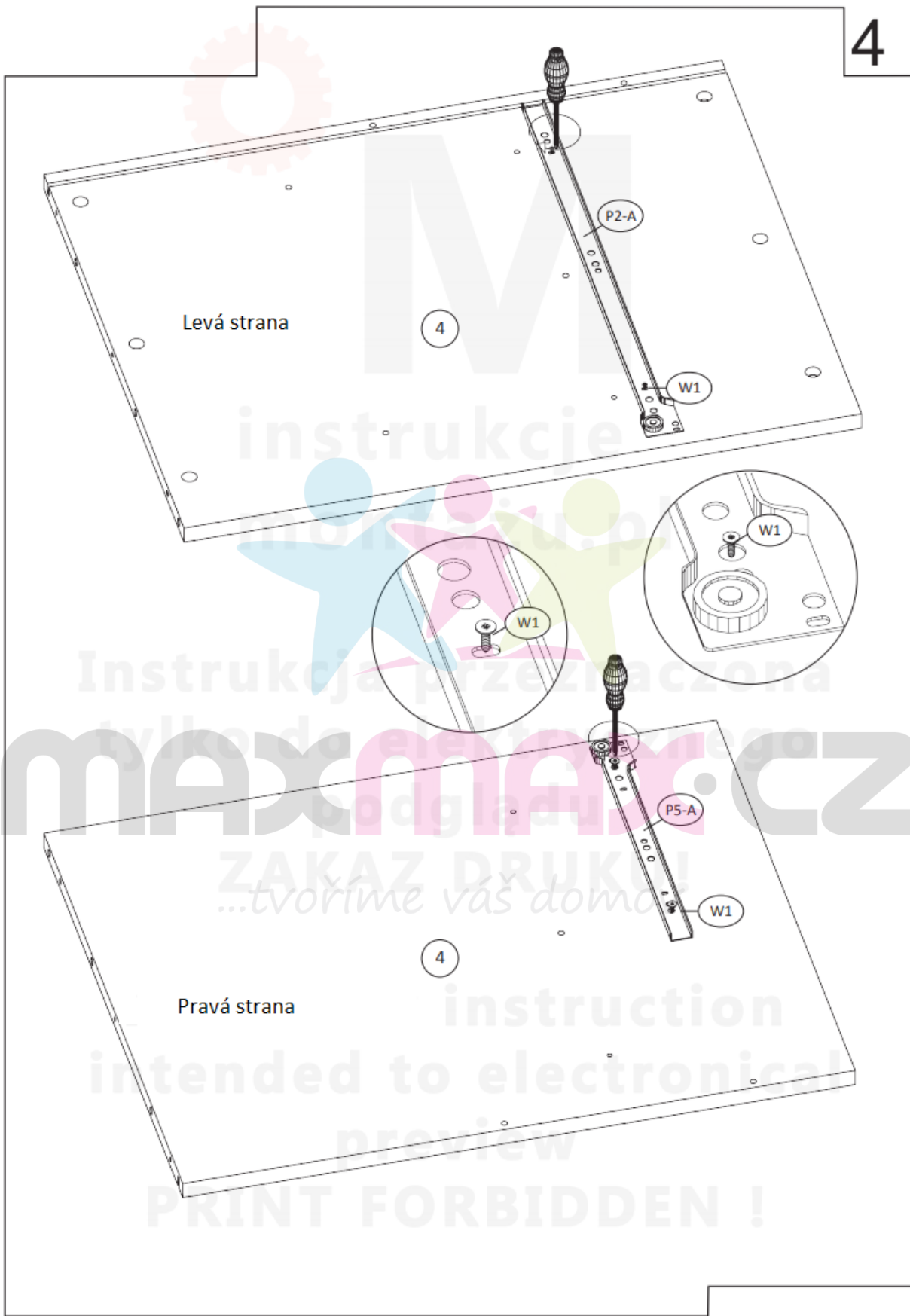
IF MISSING PARTS OR SOME OF THEM ARE DAMAGED, PLEASE CONTACT OUR CUSTOMER SERVICE OFFICE.  
DAMAGES FOUND AFTER ASSEMBLING WILL NOT BE CONSIDERED !!!



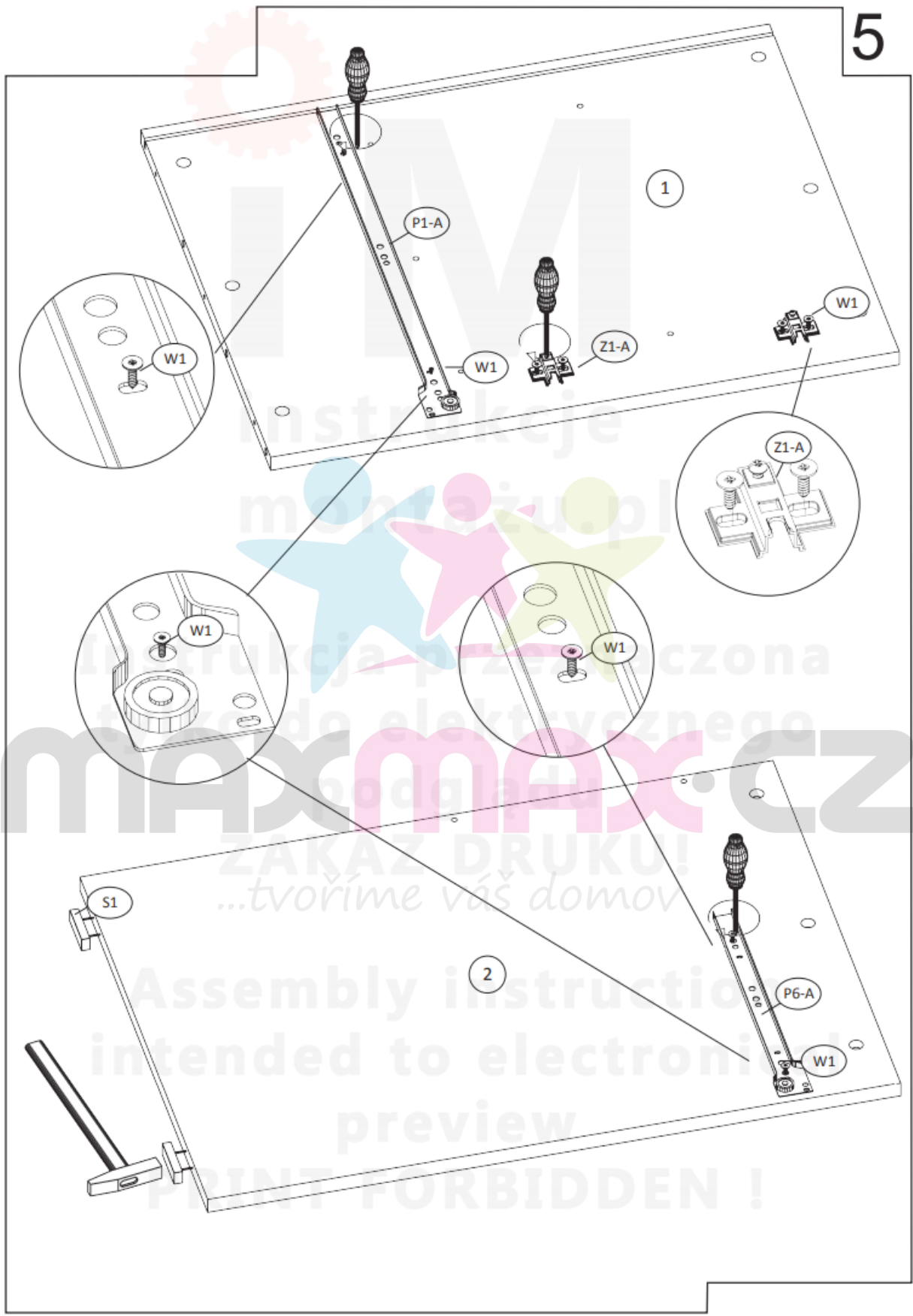

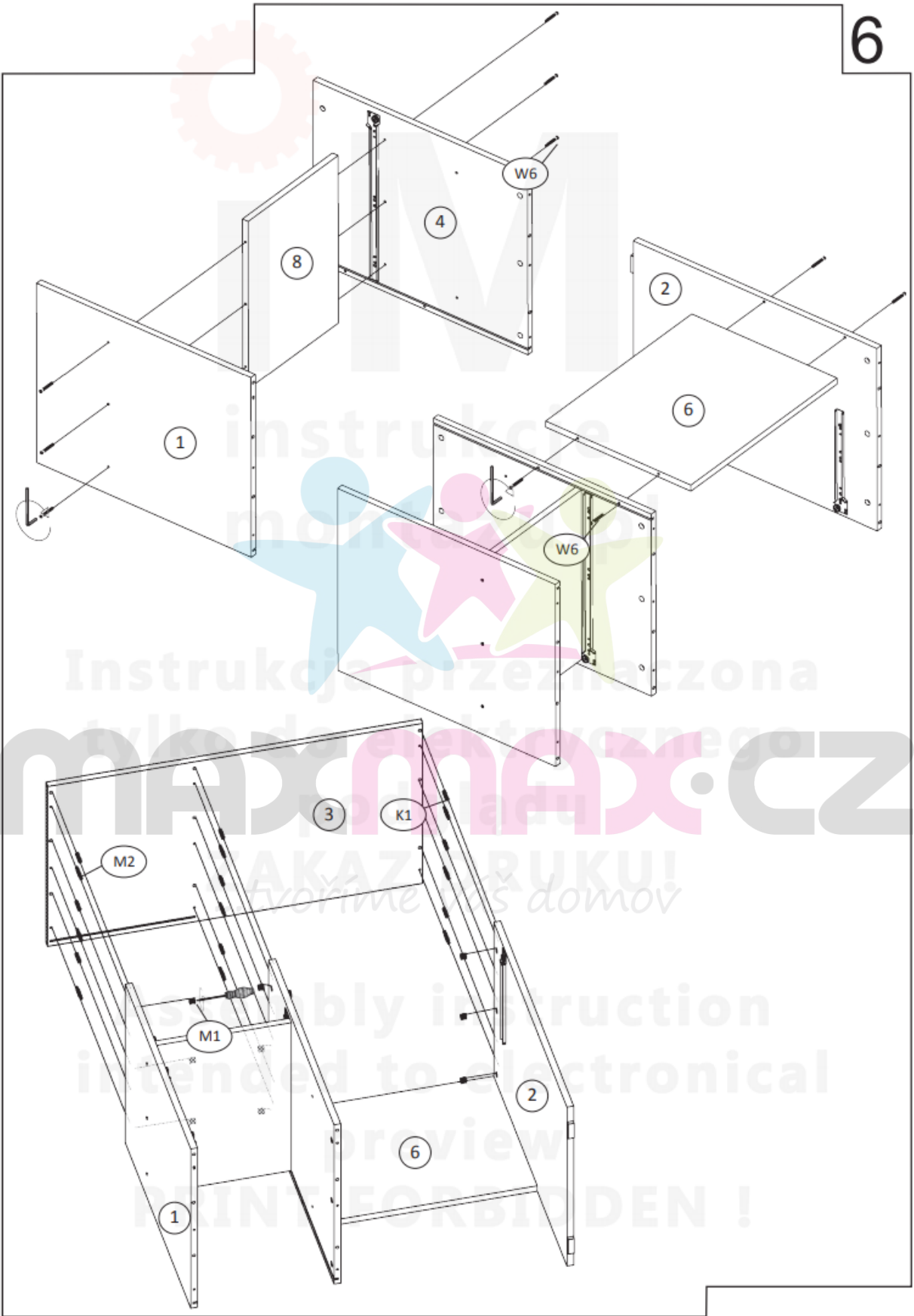

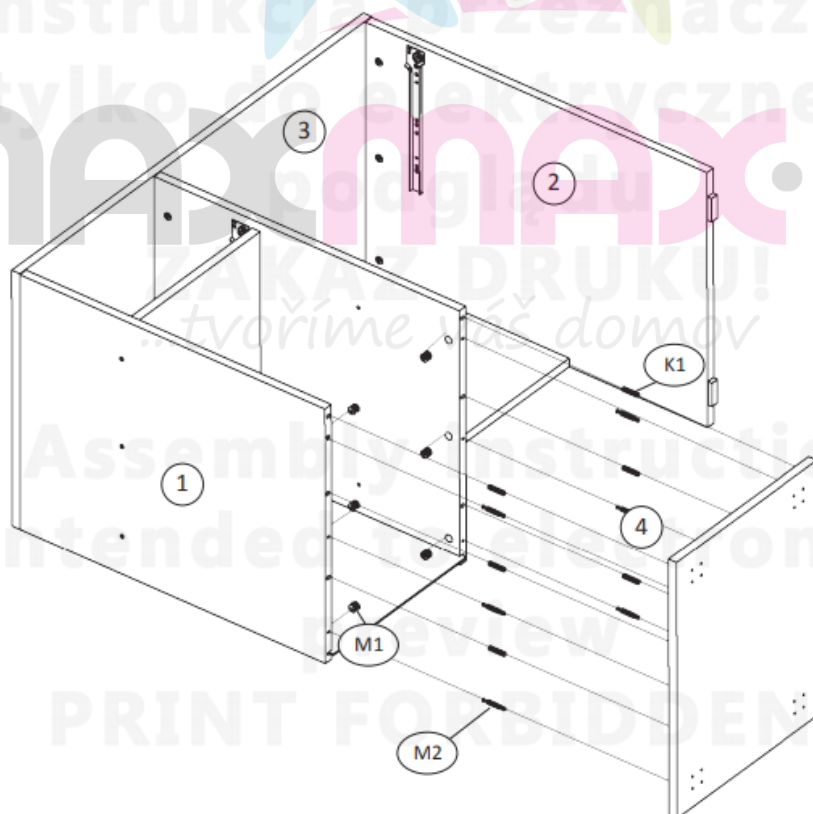
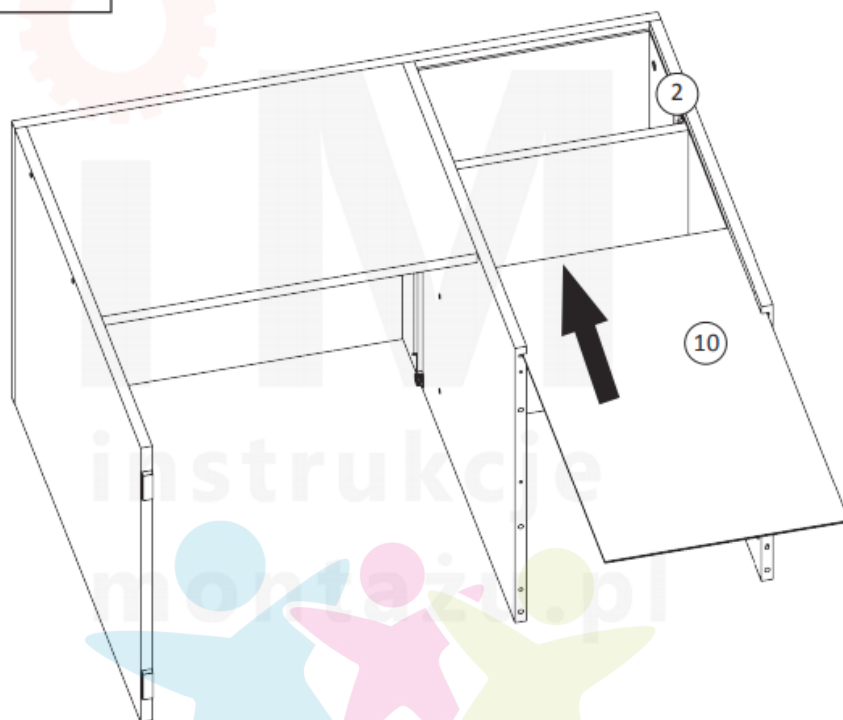



A=B

B

A

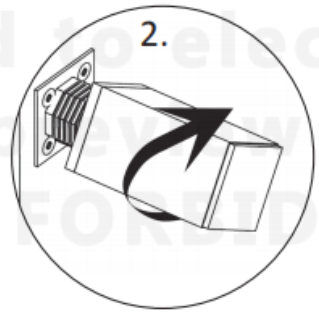
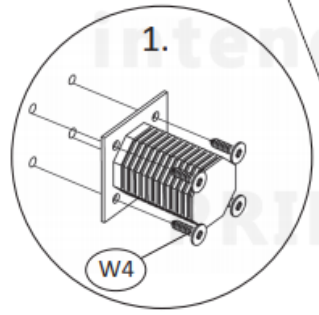
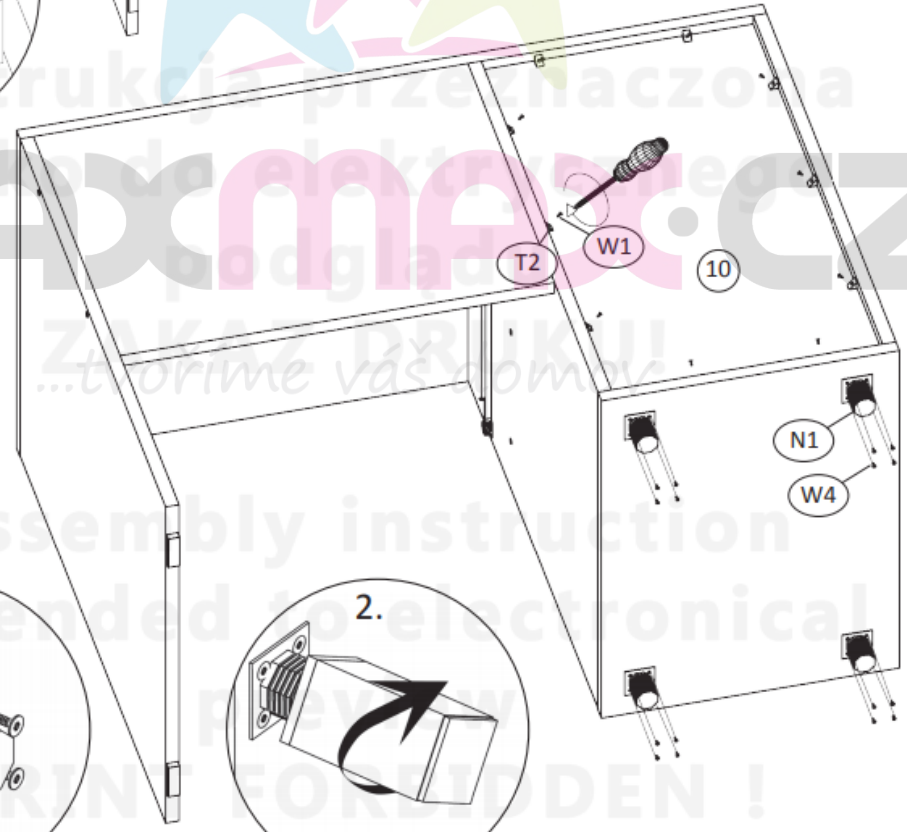
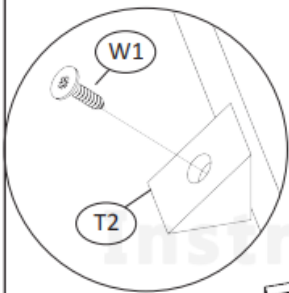

instrukcje montażu.pl

instrukcja przeznaczona wyłącznie do elektrycznego podglądu

MAXMAX.CZ

ZAKAZ DRUKU!

...tłumie váš domov

Assembly instruction intended for electrical PRINT FOR EIDEN !



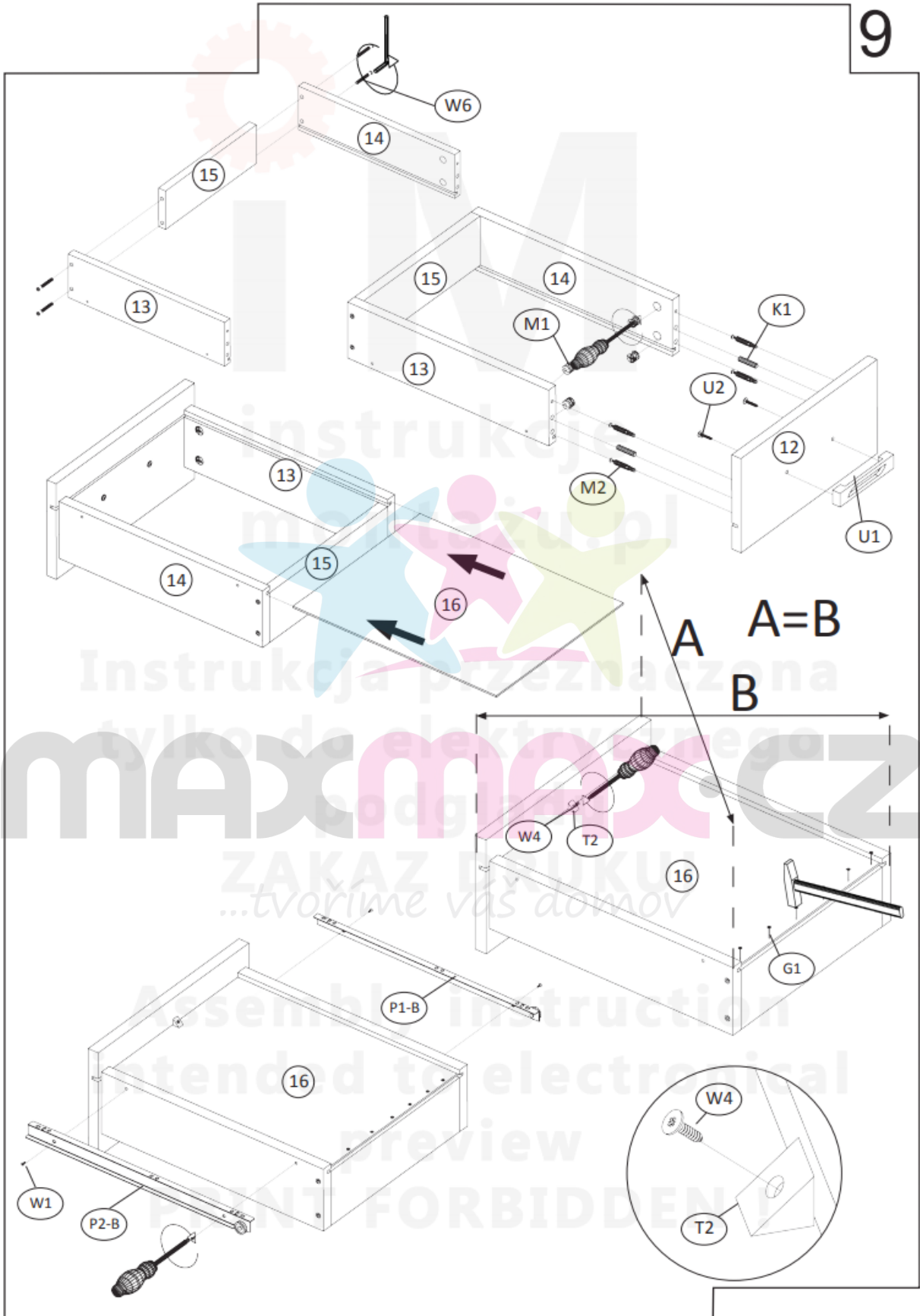

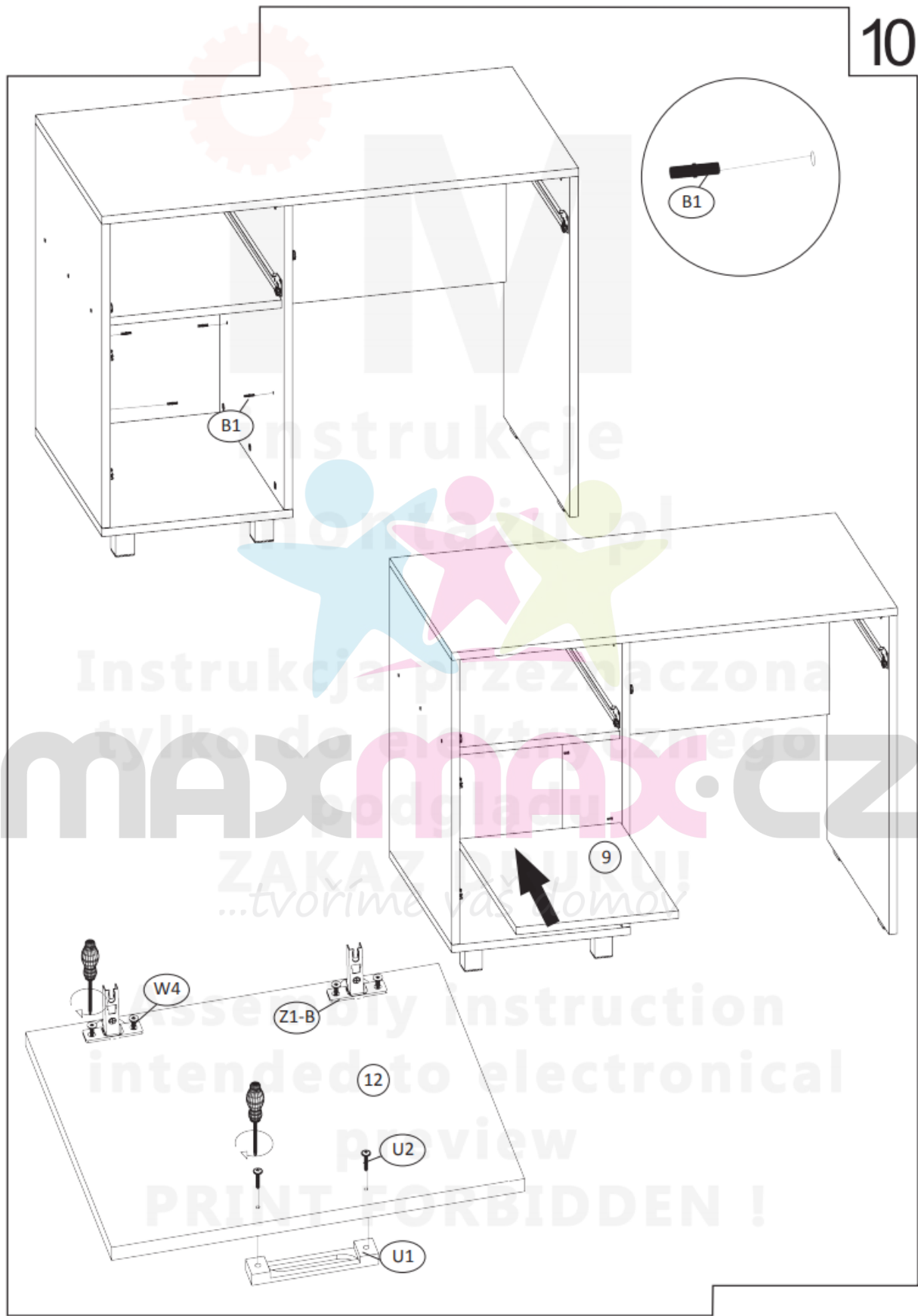

Instrukcja przeznaczona  
tylko do elektronicznego  
MAXMAX.CZ  
ZAKAZ DRUKU!  
...tvoríme vaš domov  
Assembly instruction  
intended to be printed  
electronically  
PRINT FORBIDDEN!

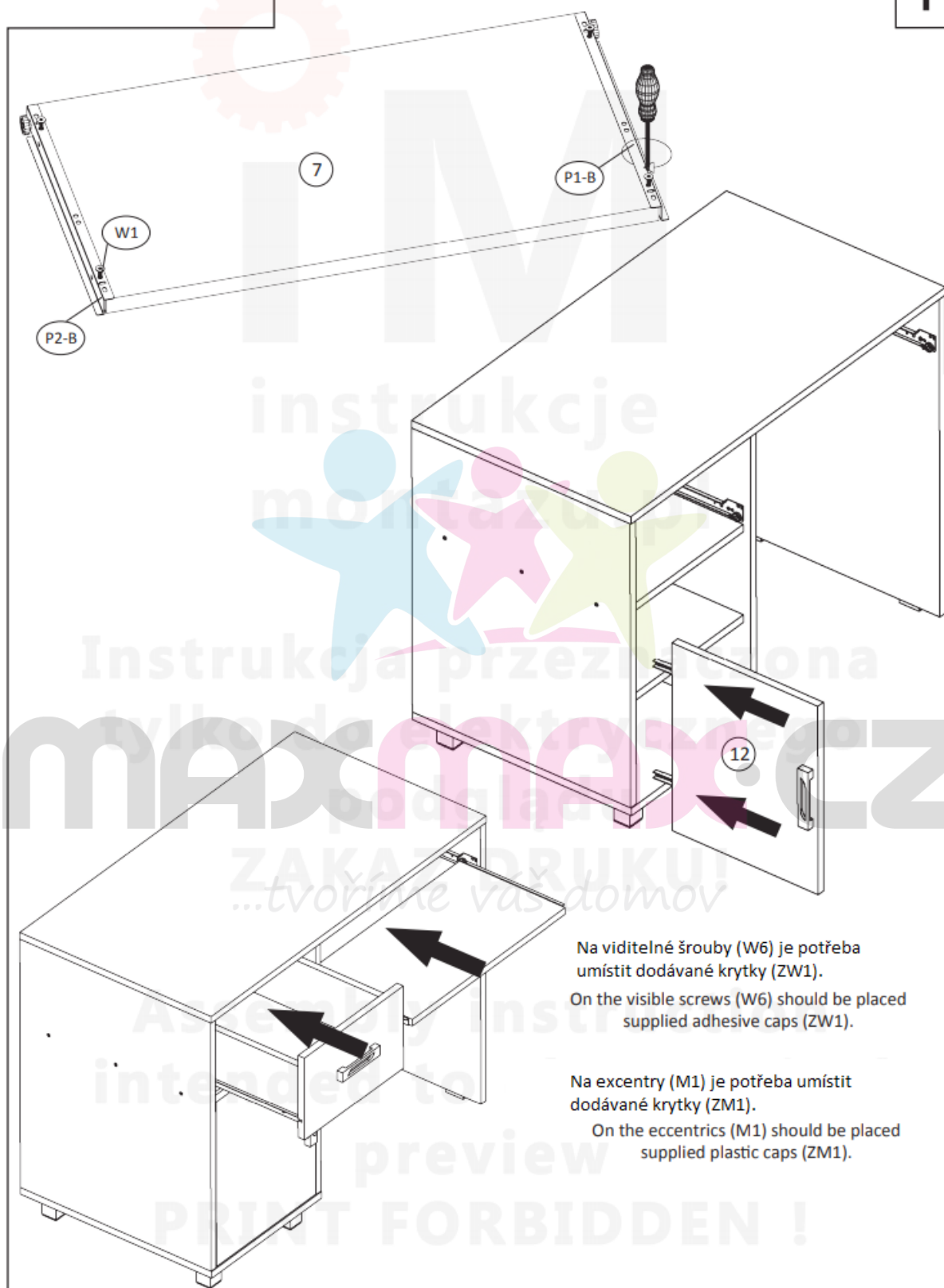

Na viditeľné šrouby (W6) je potreba umiestiť dodávané krytky (ZW1).

On the visible screws (W6) should be placed supplied adhesive caps (ZW1).

Na excentry (M1) je potreba umiestiť dodávané krytky (ZM1).

On the eccentrics (M1) should be placed supplied plastic caps (ZM1).

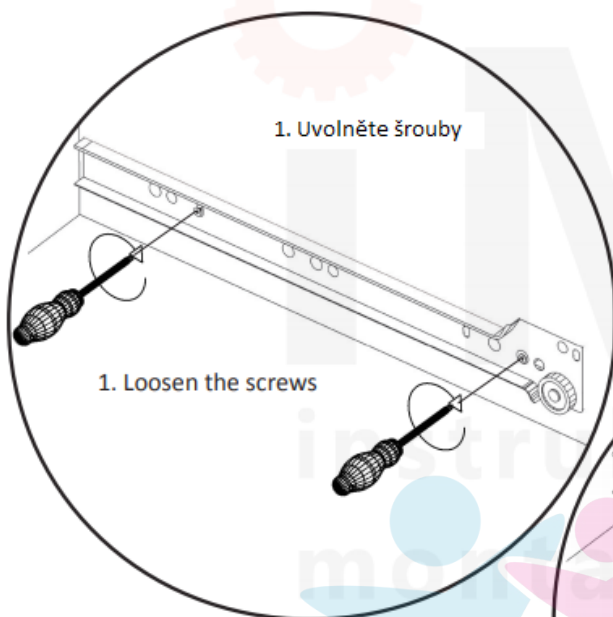

1. Uvolněte šrouby

1. Loosen the screws

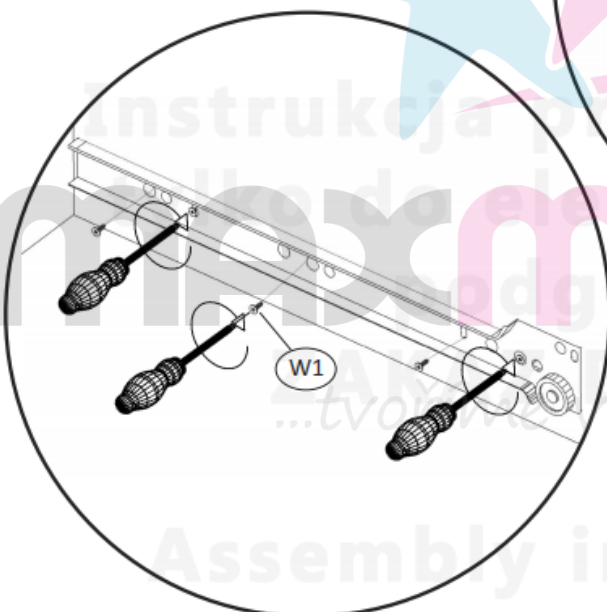

3. Tighten the screws loosened earlier.

4. Slide the drawer and check their positions.

5. If the drawers are mounted properly tighten another 3 screws to stabilize each drawer runner.

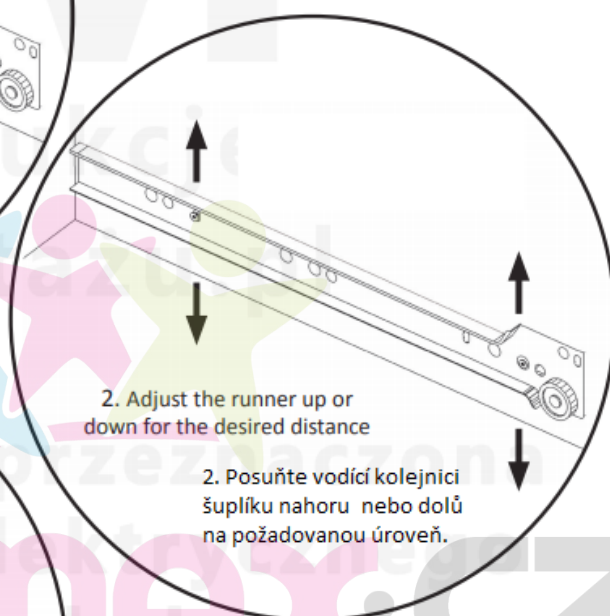

2. Adjust the runner up or down for the desired distance

2. Posuňte vodící kolejnici šuplíku nahoru nebo dolů na požadovanou úroveň.

3. Utáhněte dříve uvolněné šrouby.

4. Zasuňte zásuvku a zkontrolujte její polohu.

5. Pokud je zásuvka správně umístěna, zašroubujte další tři šrouby pro stabilizaci.

**V případě potřeby opakujte jednotlivé kroky.**

**If necessary, repeat the steps.**