





















## Dětský psací stůl ANIMALS TYP 2 B02

### NÁVOD K MONTÁŽI



#### Příslušenství / Fittings

W1  Ø3 x 16 60 ks / pcs	W4  Ø4 x 16 32 ks / pcs	W6  Ø6,3 x 50 26 ks / pcs	U1  4 ks / pcs	U2  8 ks / pcs	ZM1  36 ks / pcs	ZW1  26 ks / pcs
P1-A  500 mm 4 ks / pcs	P1-B  500 mm 4 ks / pcs	P2-A  500 mm 4 ks / pcs	P2-B  500 mm 4 ks / pcs	N1  8 ks / pcs	M2  36 ks / pcs	M1  36 ks / pcs
P5-A  300 mm 1 ks / pcs	P5-B  300 mm 1 ks / pcs	P6-A  300 mm 1 ks / pcs	P5-B  300 mm 1 ks / pcs	T2  18 ks / pcs	G1  17 ks / pcs	K1  32 ks / pcs

#### Nástroje / Tools



MONTÁŽ STOLU JE MOŽNÁ POUZE VE DVOU OSOBÁCH

**VELMI DŮLEŽITÉ!  
ČTĚTE PEČLIVĚ  
NÁVOD SI ULOŽTE PRO POZDĚJŠÍ POUŽITÍ  
UŽIVATELSKÁ PŘÍRUČKA**

1.  
Všecky obalový materiál odstraňte mimo dosah dětí, tak aby nemohlo dojít k udušení nebo uškrcení.
2.  
Všechny spoje musí být řádně dotaženy, žádná součástka nesmí zůstat volná.
3.  
Nábytek nepoužívejte v případě, že je nějaká součástka poškozená, či chybí.
4.  
Používejte pouze součástky dodané výrobcem.
5.  
Nepokládejte nábytek do blízkosti otevřeného ohně nebo k jiným zdrojům tepla, jako je elektrické nebo plynové topení apod., mohlo by dojít ke vznícení.

**VERY IMPORTANT!  
PLEASE READ CAREFULLY  
SAVE FOR FUTURE USE**

**USER'S MANUAL**

1.  
To avoid the danger of choking or strangulation keep the package with fittings away from babies and children.
2.  
All connections must be tightened properly and no coupled element can not be loose.
3.  
Do not use the bed when, if any of the elements is damaged or if there is any element missing.
4.  
Use only the elements given by manufacturer.
5.  
Do not place the bed near naked flames or other heat sources such as electric or gas radiators etc., this may cause a fire.

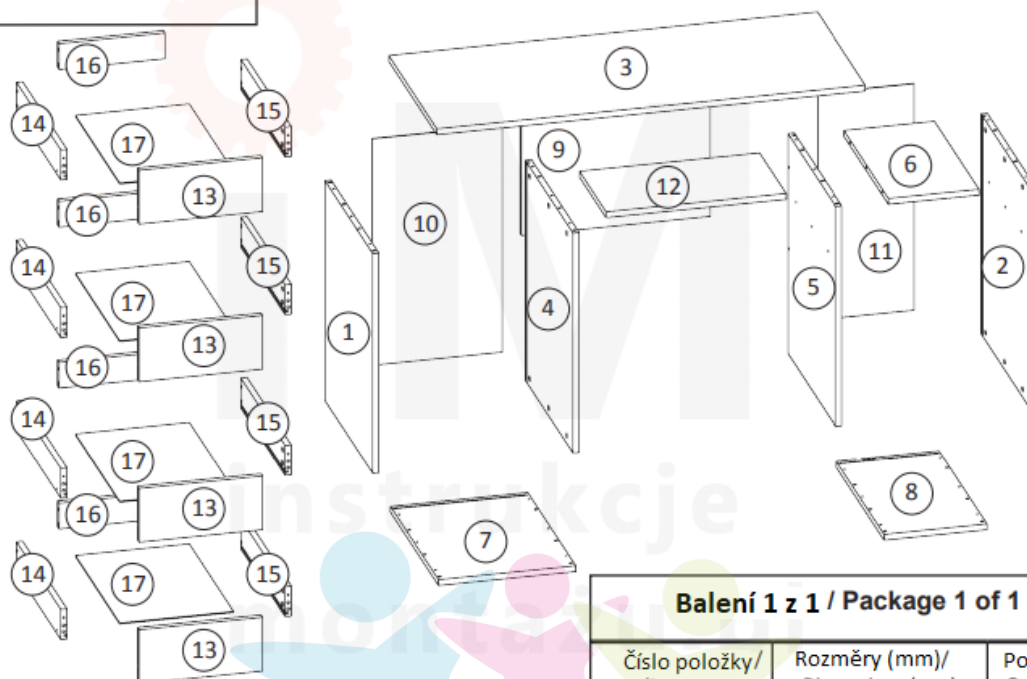

**Balení 1 z 1 / Package 1 of 1**

Číslo položky/ item no.	Rozměry (mm)/ Dimensions (mm)	Počet/ Quantity
1	674 x 598 x 18	1
2	674 x 598 x 18	1
3	1252 x 600 x 18	1
4	674 x 598 x 18	1
5	674 x 598 x 18	1
6	264 x 565 x 18	1
7	402 x 600 x 18	1
8	302 x 600 x 18	1
9	550 x 450 x 18	1
10	382 x 692 x 3	1
11	282 x 692 x 3	1
12	525 x 300 x 18	1
13	360 x 166 x 18	4
14	500 x 124 x 18	4
15	500 x 124 x 18	4
16	303 x 106 x 18	4
17	321 x 504 x 3	4

Před montáží se ujistěte, že balení obsahuje všechny položky uvedené na této stránce a zkontrolujte, jestli žádná z položek není poškozena. V případě, že některá z položek chybí nebo jeví známky poškození, kontaktujte prodejce tohoto výrobku.

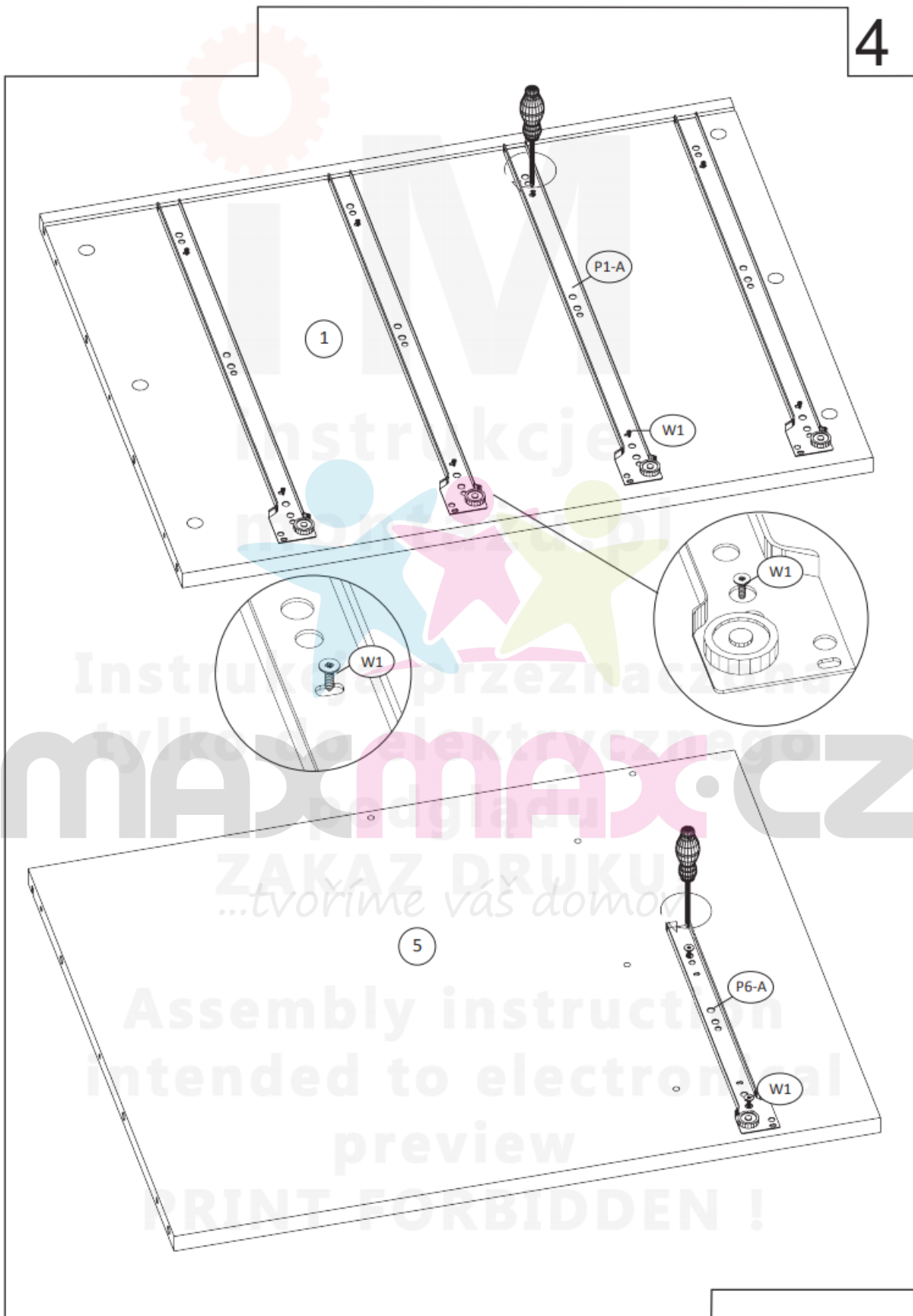
BEFORE ASSEMBLING THE FURNITURE PLEASE CHECK THAT PACKAGES INCLUDE ALL ITEMS LISTED IN THE TABLE ON PAGE NO 3, AND WHETHER THESE ITEMS ARE NOT DAMAGED !!!  
IF MISSING PARTS OR SOME OF THEM ARE DAMAGED, PLEASE CONTACT OUR CUSTOMER SERVICE OFFICE.  
DAMAGES FOUND AFTER ASSEMBLING WILL NOT BE CONSIDERED !!!

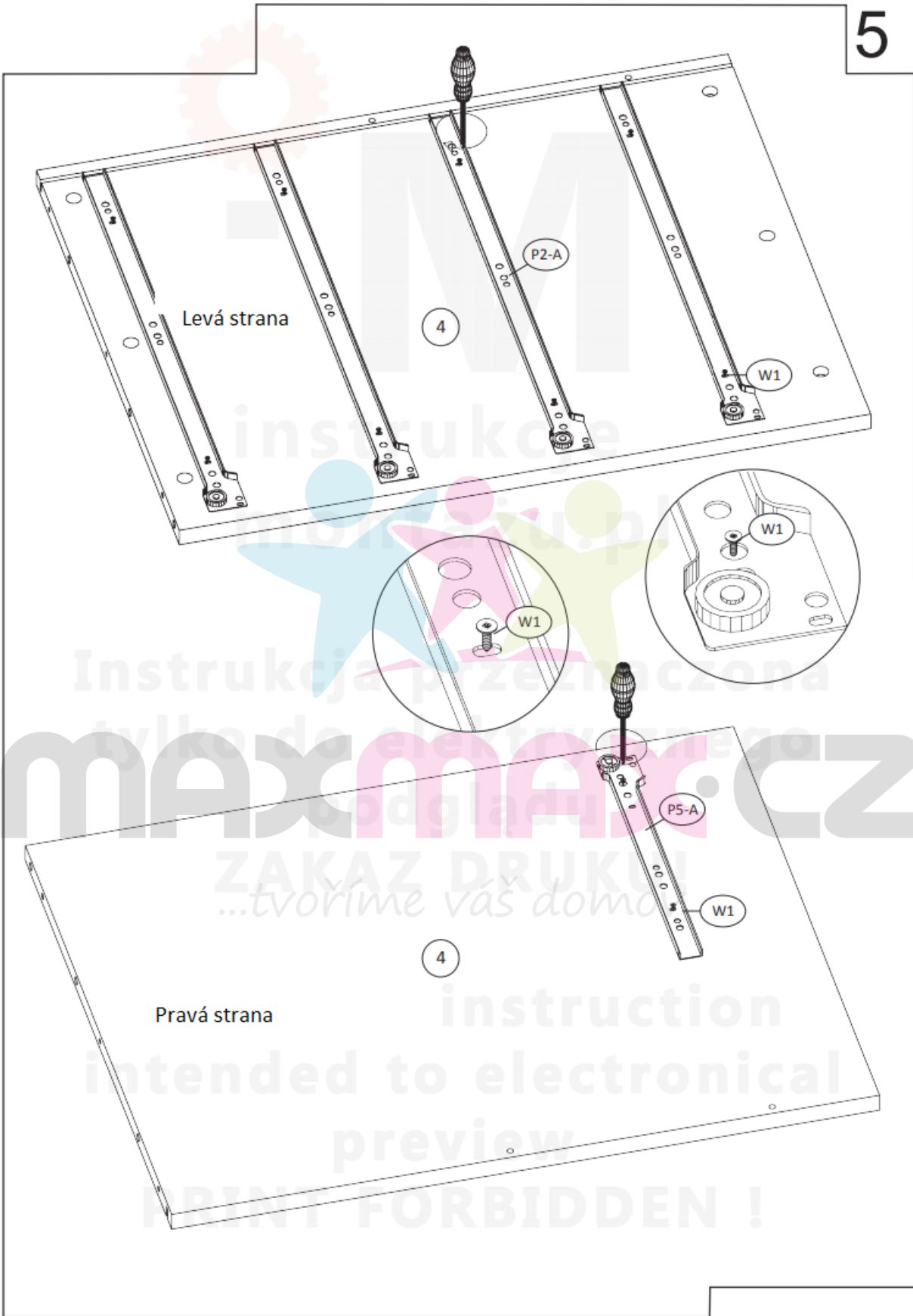



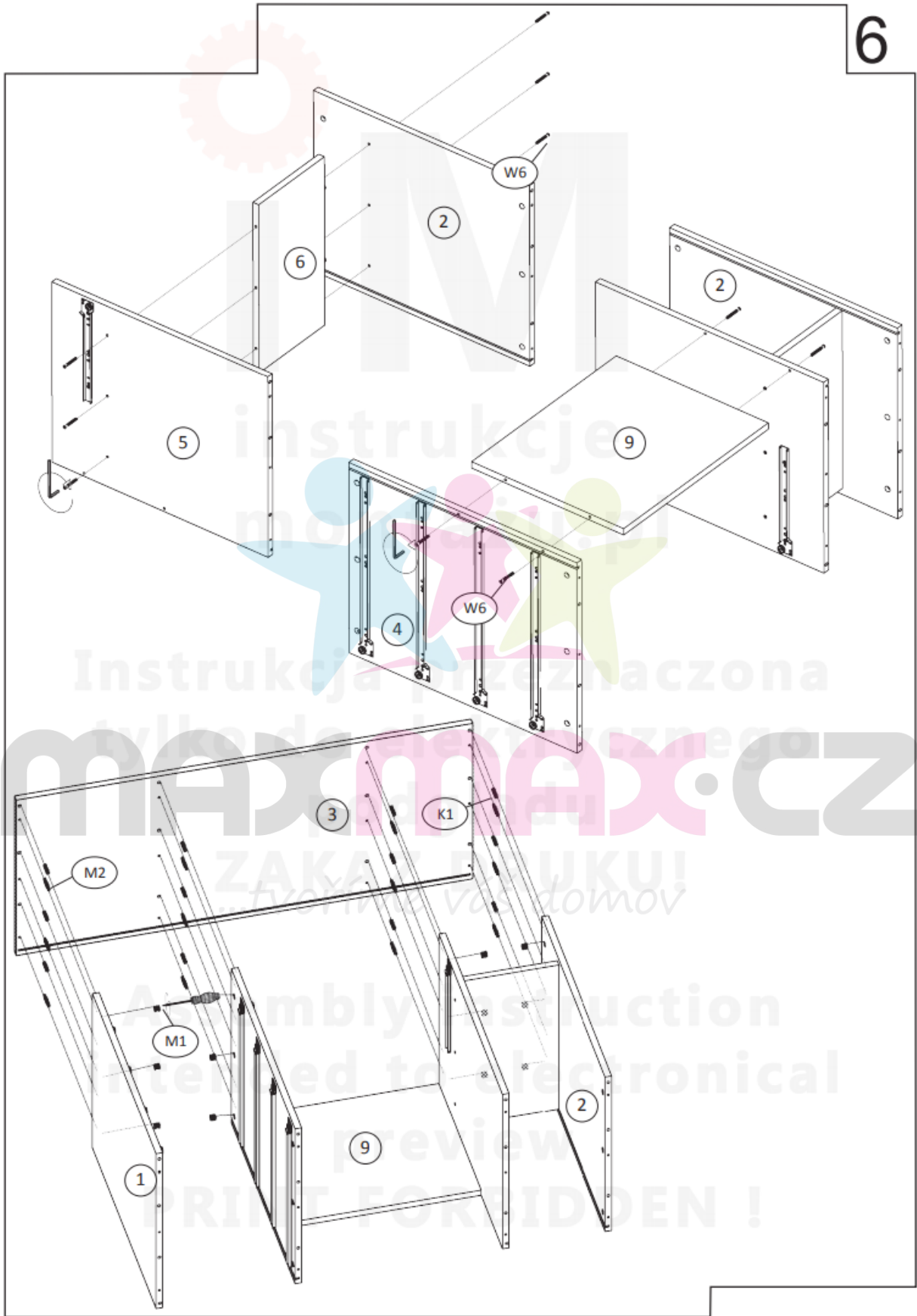

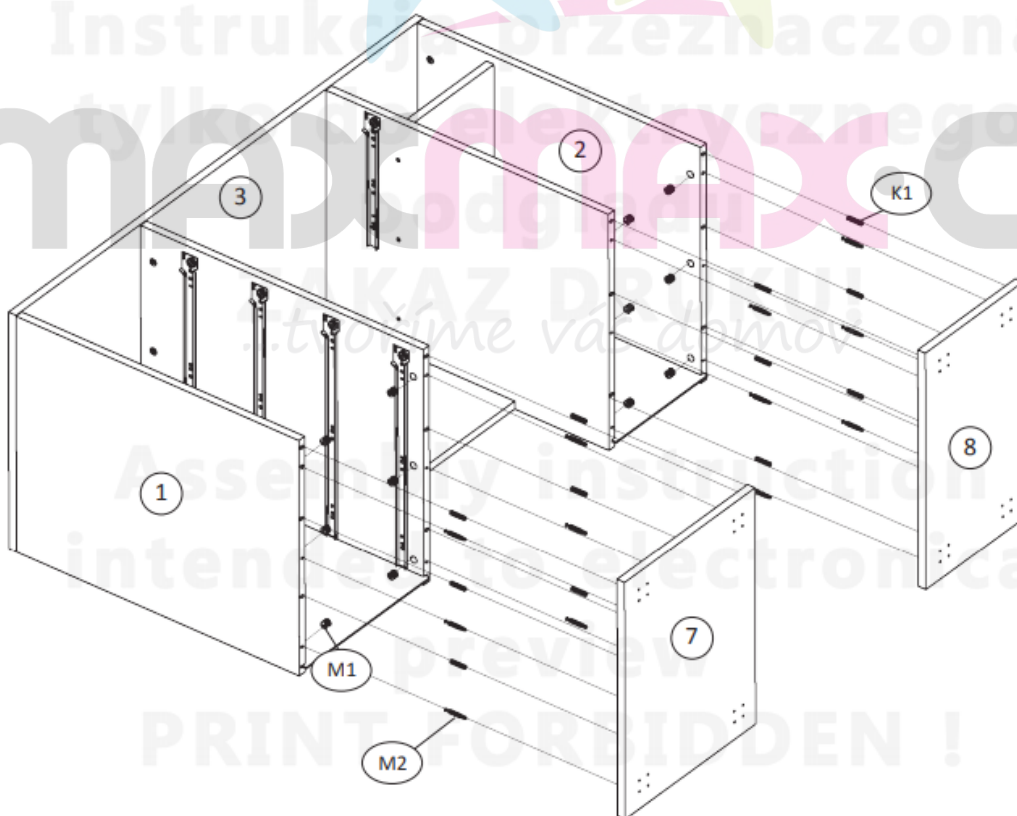
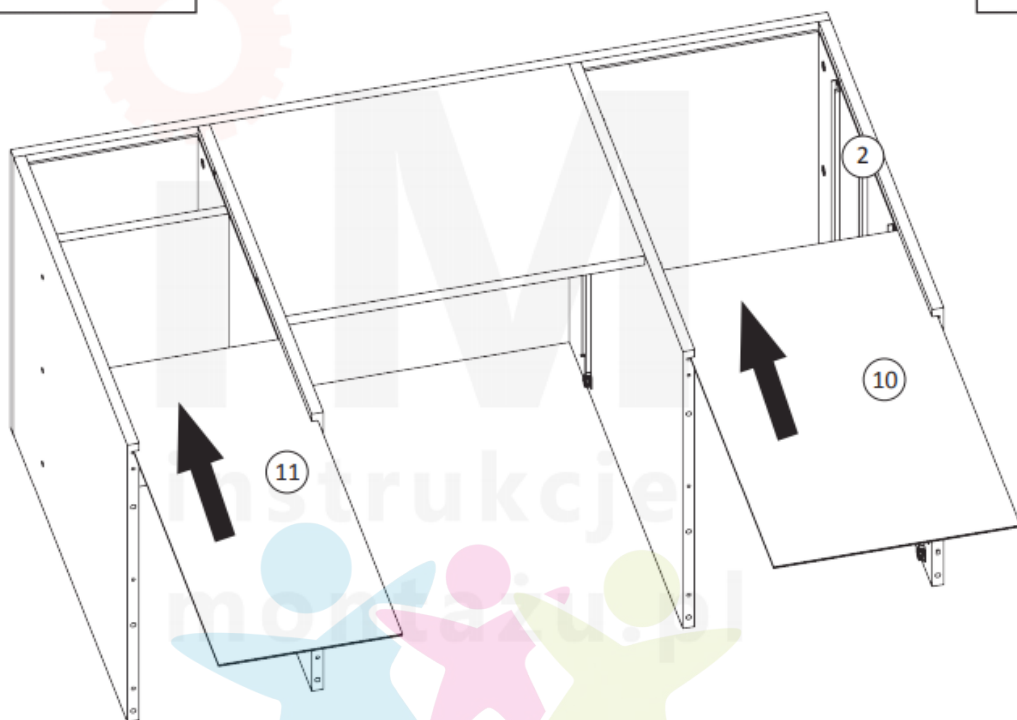

Instrukcje montażu

Instrukcja przeznaczona tylko do elektronicznego montażu

WYKAZ DZIAŁAŁ

Assembley instruction intended for electronic preview

PRINT FORBIDDEN!

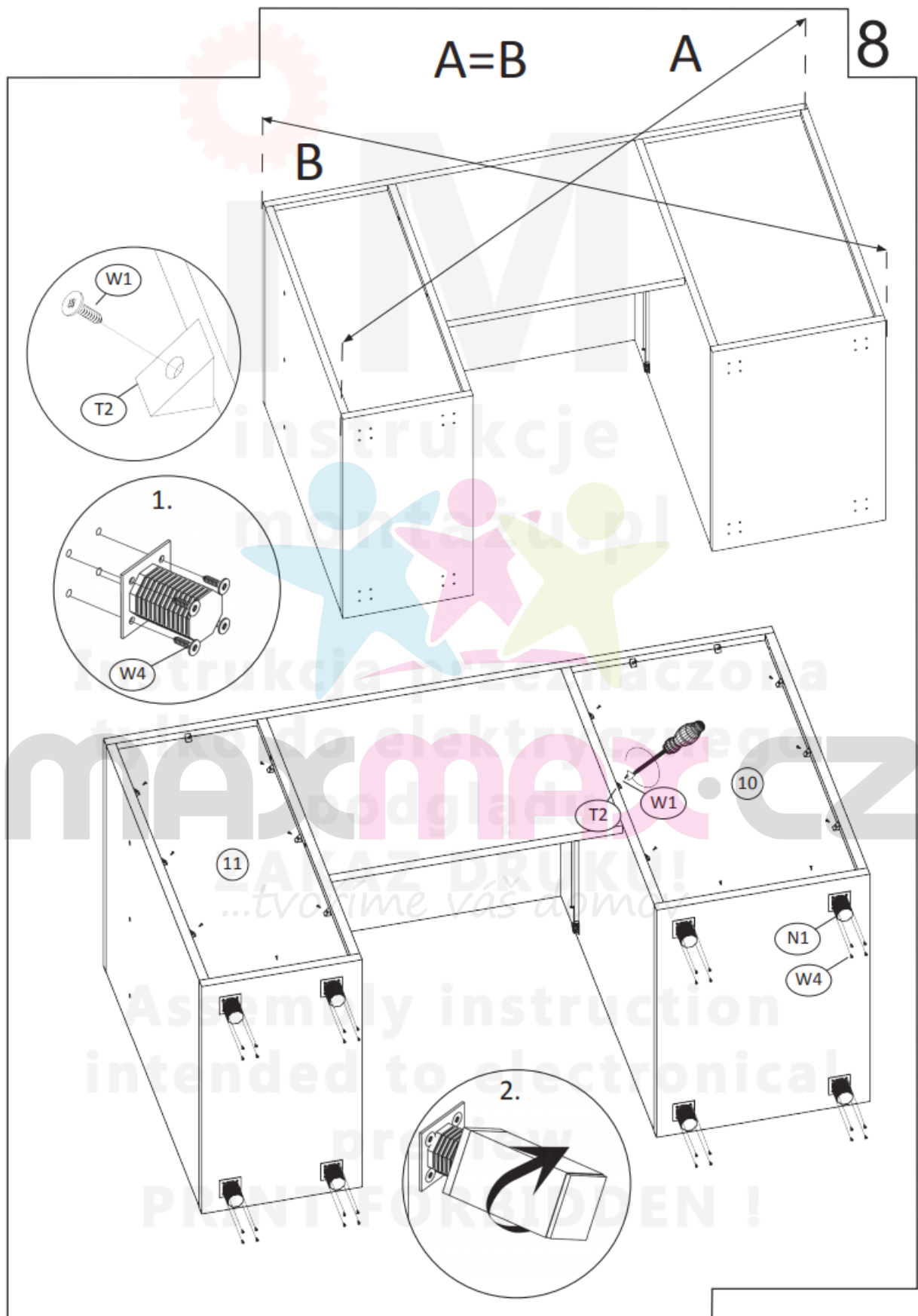



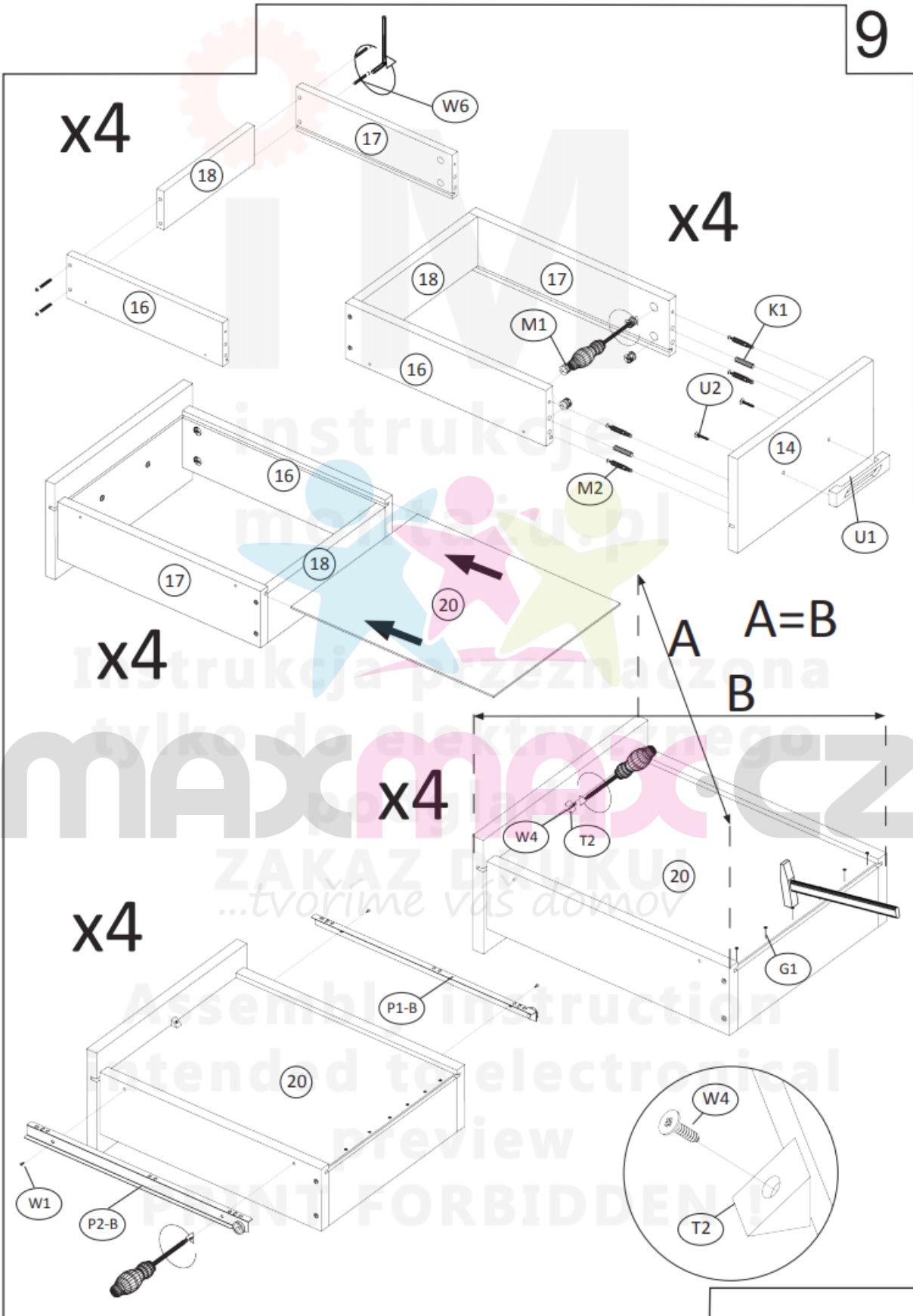

x4

x4

x4

x4

x4

A=B

B

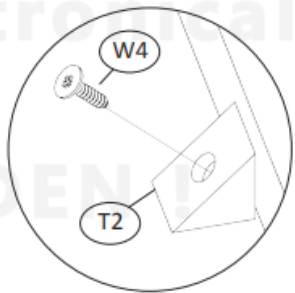

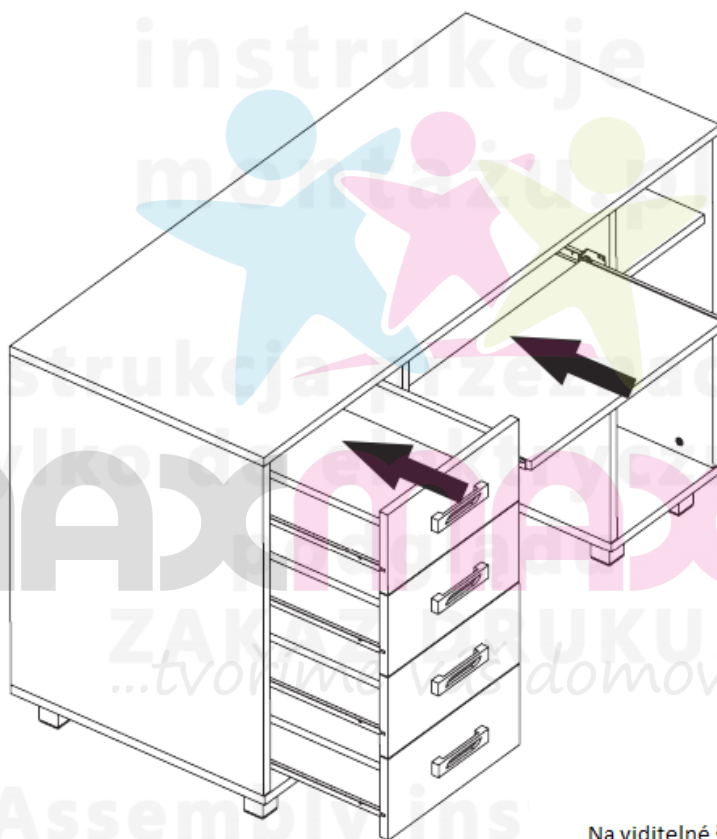
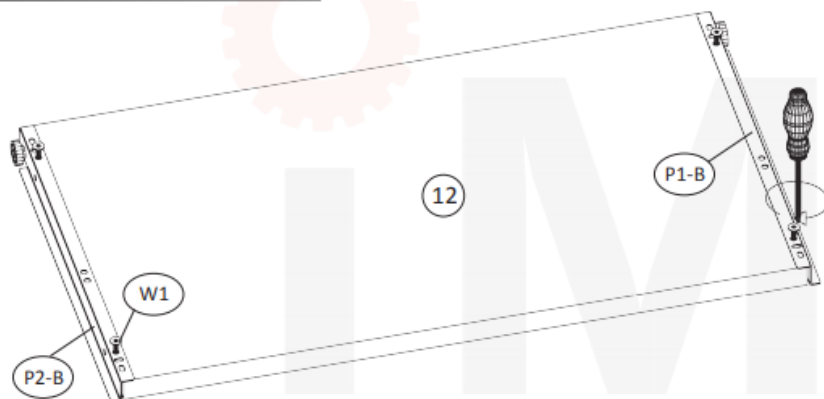

Na viditelné šrouby (W6) je potřeba umístit dodávané krytky (ZW1).

On the visible screws (W6) should be placed supplied adhesive caps (ZW1).

Na excentry (M1) je potřeba umístit dodávané krytky (ZM1).

On the eccentrics (M1) should be placed supplied plastic caps (ZM1).

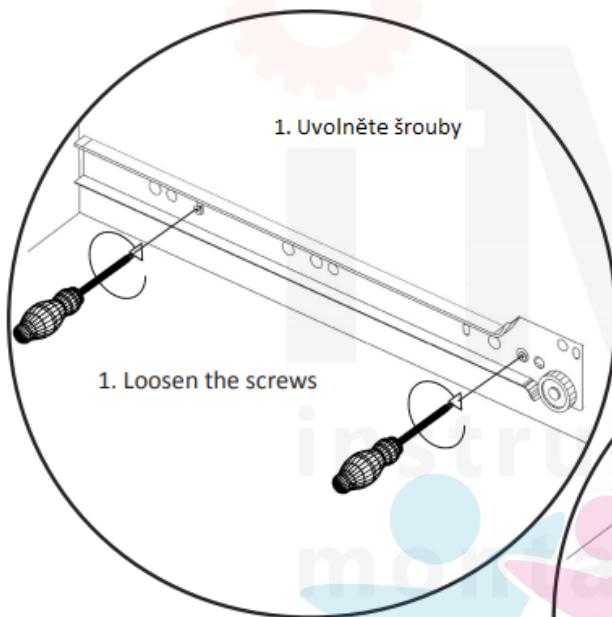

1. Uvolněte šrouby

1. Loosen the screws

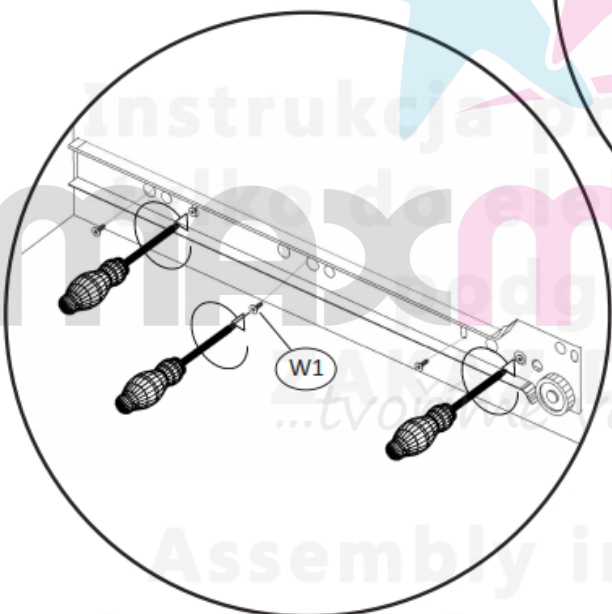

3. Tighten the screws loosened earlier.

4. Slide the drawer and check their positions.

5. If the drawers are mounted properly tighten another 3 screws to stabilize each drawer runner.

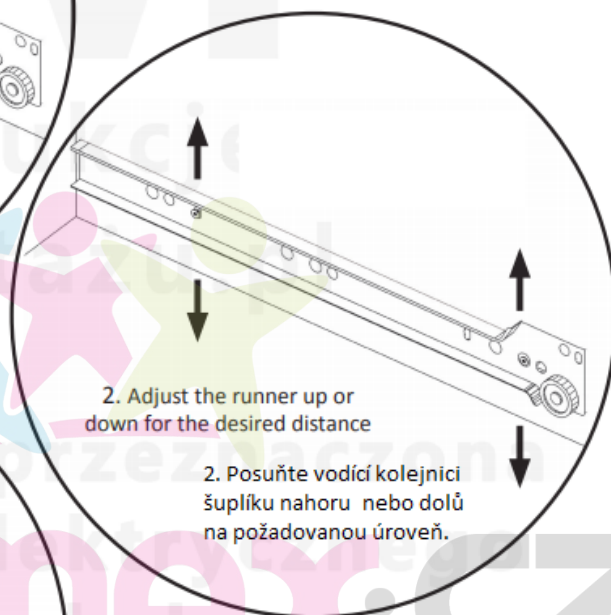

2. Adjust the runner up or down for the desired distance

2. Posuňte vodící kolejnici šuplíku nahoru nebo dolů na požadovanou úroveň.

3. Utáhněte dříve uvolněné šrouby.

4. Zasuňte zásuvku a zkontrolujte její polohu.

5. Pokud je zásuvka správně umístěna, zašroubujte další tři šrouby pro stabilizaci.

**V případě potřeby opakujte jednotlivé kroky.  
If necessary, repeat the steps.**