

























Dětský psací stůl ANIMALS TYP 4 B04

NÁVOD K MONTÁŽI

Příslušenství / Fittings						
K1 	M2 	M1 	ZM1 	ZW1 	T2 	G1 
17 ks / pcs	13 ks / pcs	13 ks / pcs	13 ks / pcs	14 ks / pcs	12 ks / pcs	6 ks / pcs
W1  Ø3 x 16	B1 	W4  Ø4 x 16	W6  Ø6,3 x 50	U1 	U2 	N1 
24 ks / pcs	6 ks / pcs	24 ks / pcs	14 ks / pcs	2 ks / pcs	4 ks / pcs	4 ks / pcs
P1-A  500 mm	P1-B  500 mm	P2-A  500 mm	P2-B  500 mm	S1 	Z1-A 	Z1-B 
1 ks / pcs	1 ks / pcs	1 ks / pcs	1 ks / pcs	2 ks / pcs	2 ks / pcs	2 ks / pcs
P5-A  300 mm	P5-B  300 mm	P6-A  300 mm	P5-B  300 mm			
1 ks / pcs	1 ks / pcs	1 ks / pcs	1 ks / pcs			

Nástroje / Tools		
		

MONTÁŽ STOLU JE MOŽNÁ POUZE VE DVOU OSOBÁCH

**VELMI DŮLEŽITÉ!
ČTĚTE PEČLIVĚ
NÁVOD SI ULOŽTE PRO POZDĚJŠÍ POUŽITÍ
UŽIVATELSKÁ PŘÍRUČKA**

1.
Všecky obalový materiál odstraňte mimo dosah dětí, tak aby nemohlo dojít k udušení nebo uškrcení.
2.
Všechny spoje musí být řádně dotaženy, žádná součástka nesmí zůstat volná.
3.
Nábytek nepoužívejte v případě, že je nějaká součástka poškozená, či chybí.
4.
Používejte pouze součástky dodané výrobcem.
5.
Nepokládejte nábytek do blízkosti otevřeného ohně nebo k jiným zdrojům tepla, jako je elektrické nebo plynové topení apod., mohlo by dojít ke vznícení.

**VERY IMPORTANT!
PLEASE READ CAREFULLY
SAVE FOR FUTURE USE**

USER'S MANUAL

1.
To avoid the danger of choking or strangulation keep the package with fittings away from babies and children.
2.
All connections must be tightened properly and no coupled element can not be loose.
3.
Do not use the bed when, if any of the elements is damaged or if there is any element missing.
4.
Use only the elements given by manufacturer.
5.
Do not place the bed near naked flames or other heat sources such as electric or gas radiators etc., this may cause a fire.

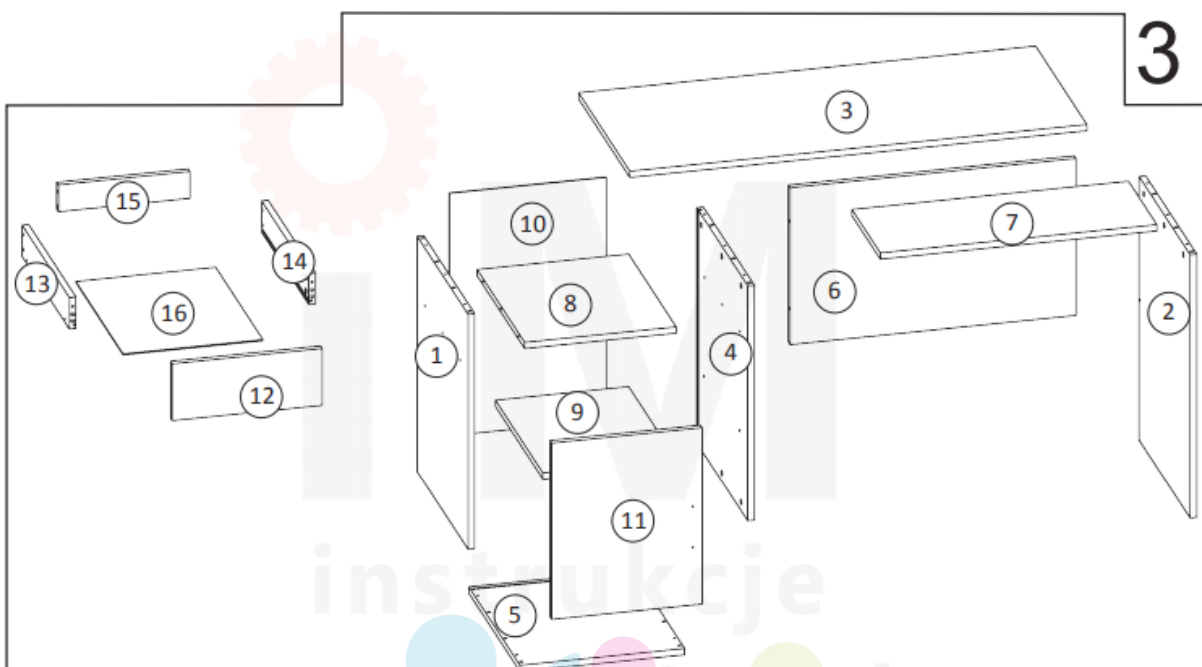
Balení 1 z 1/ Package 1 of 1

Číslo položky / item no.	Rozměry (mm) / Dimensions (mm)	Počet / Quantity
1	674 x 598 x 18	1
2	752 x 598 x 18	1
3	1252 x 600 x 18	1
4	674 x 598 x 18	1
5	425 x 600 x 18	1
6	782 x 450 x 18	1
7	757 x 300 x 18	1
8	414 x 565 x 18	1
9	414 x 555 x 18	1
10	432 x 692 x 3	1
11	410 x 504 x 18	1
12	410 x 166 x 18	1
13	500 x 124 x 18	1
14	500 x 124 x 18	1
15	353 x 106 x 18	1
16	371 x 504 x 3	1

Před montáží se ujistěte, že balení obsahuje všechny položky uvedené na této stránce a zkontrolujte, jestli žádná z položek není poškozena. V případě, že některá z položek chybí nebo jeví známky poškození, kontaktujte prodejce tohoto výrobku.

 BEFORE ASSEMBLING THE FURNITURE PLEASE CHECK THAT PACKAGES INCLUDE ALL ITEMS LISTED IN THE TABLE ON PAGE NO 3, AND WHETHER THESE ITEMS ARE NOT DAMAGED !!!
 IF MISSING PARTS OR SOME OF THEM ARE DAMAGED, PLEASE CONTACT OUR CUSTOMER SERVICE OFFICE.
 DAMAGES FOUND AFTER ASSEMBLING WILL NOT BE CONSIDERED !!!

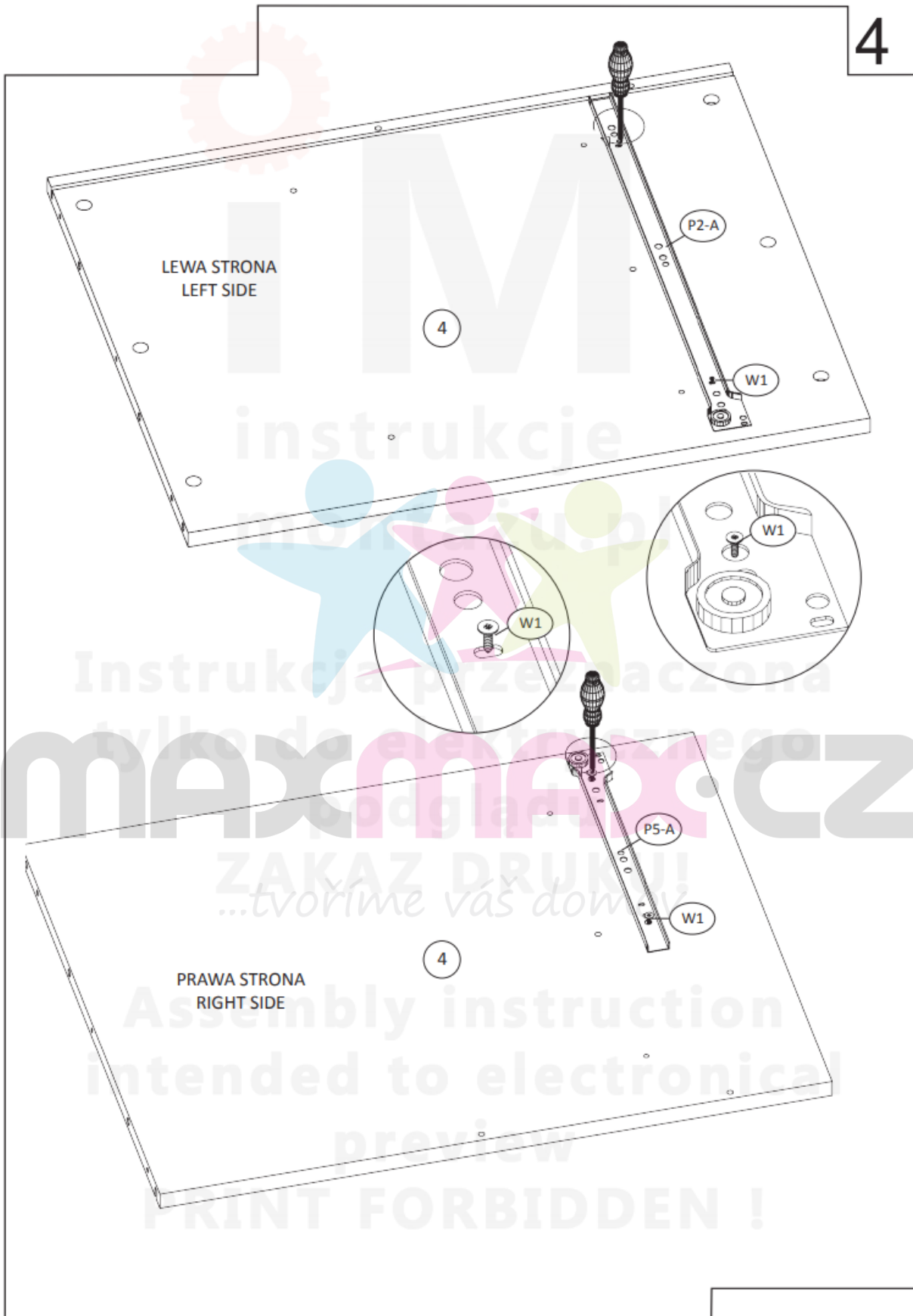

LEWA STRONA
LEFT SIDE

4

P2-A

W1

W1

W1

P5-A

W1

4

PRAWA STRONA
RIGHT SIDE

Assembly instruction

intended to electrical

preview

PRINT FORBIDDEN !

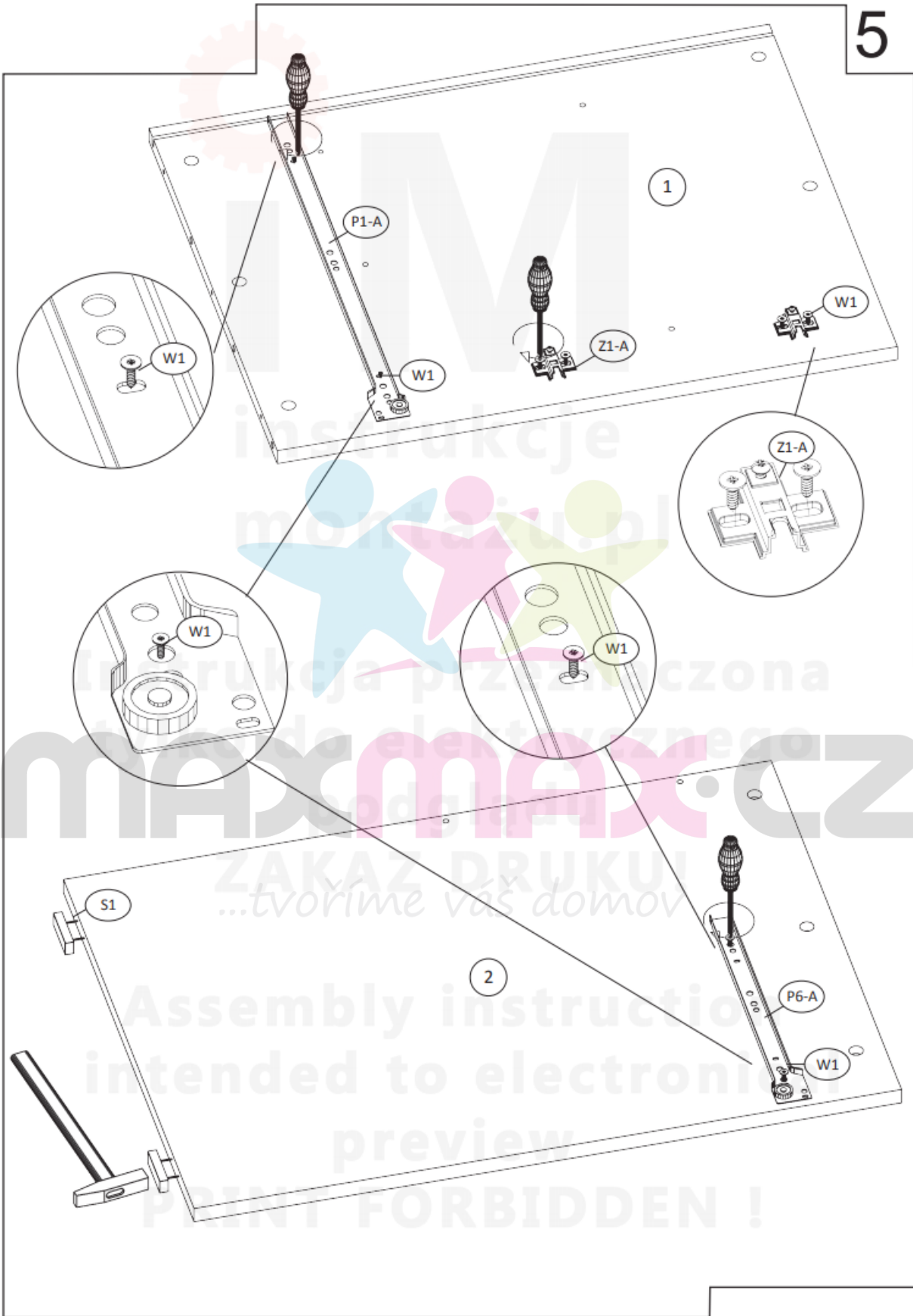

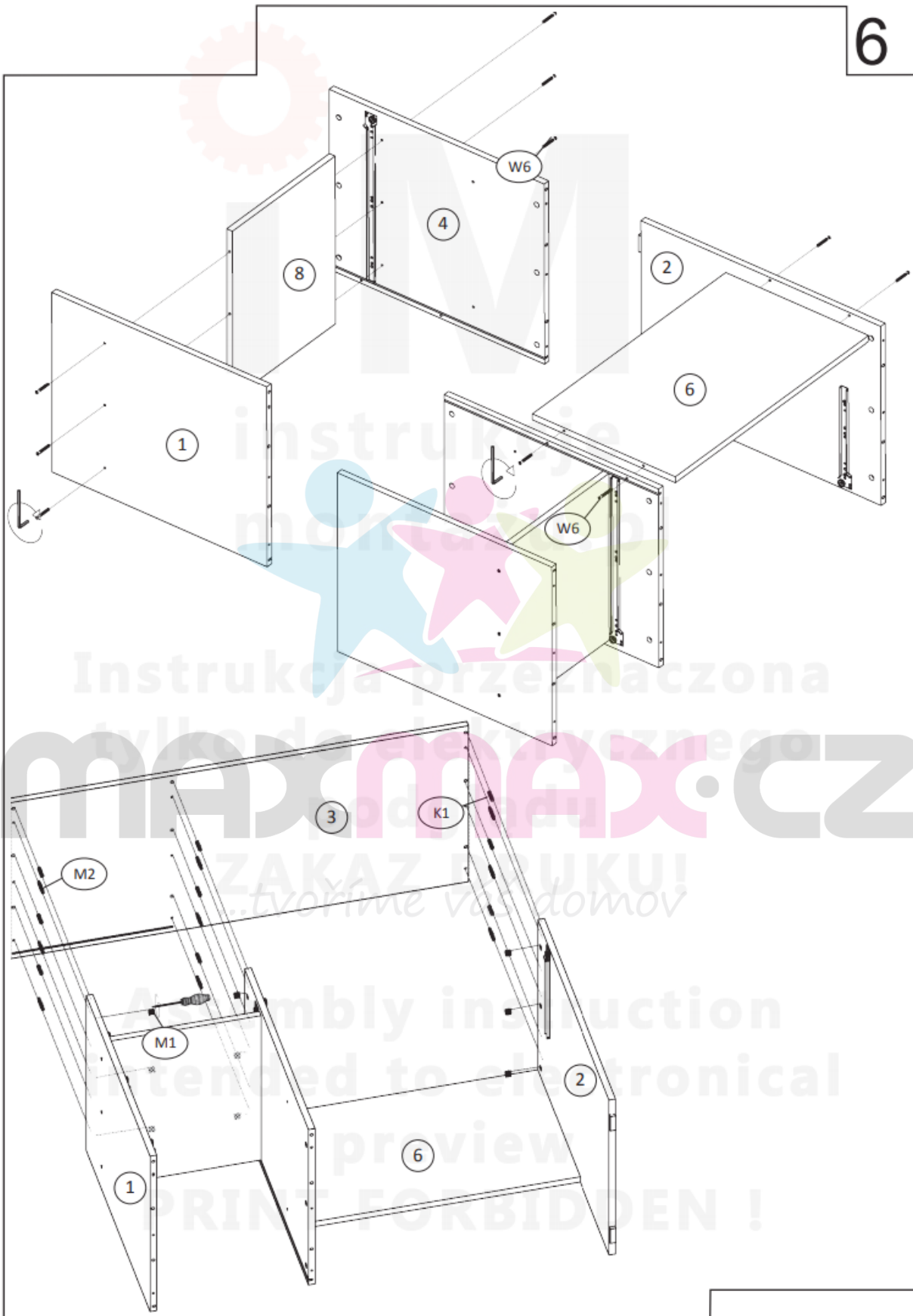

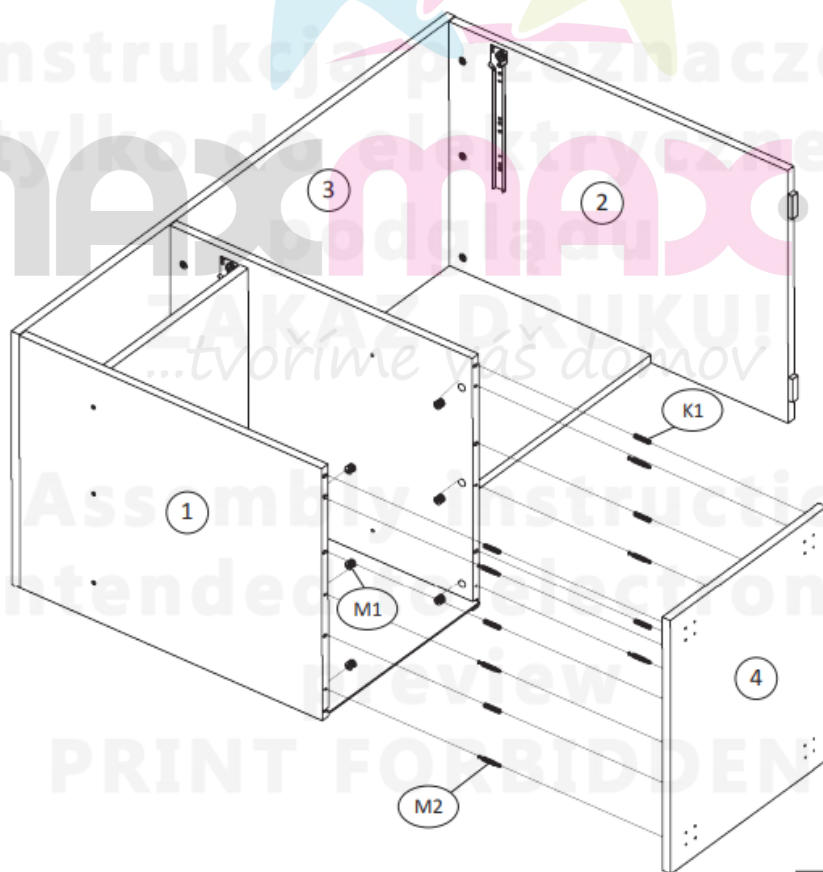
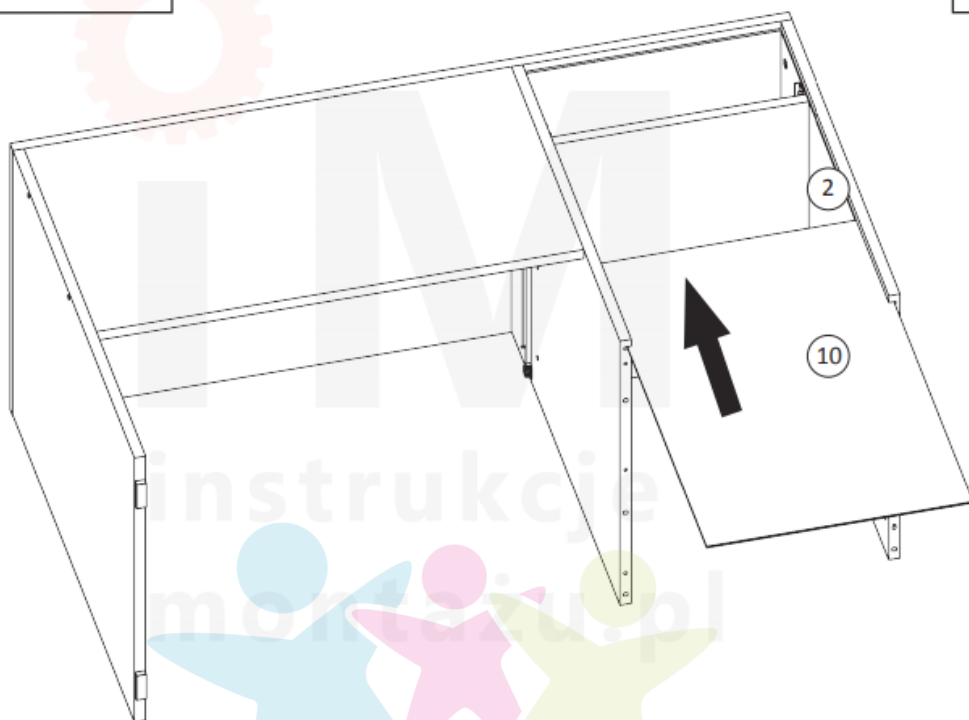

A=B

B

A

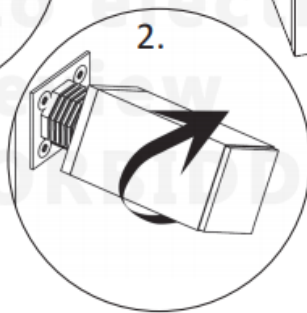
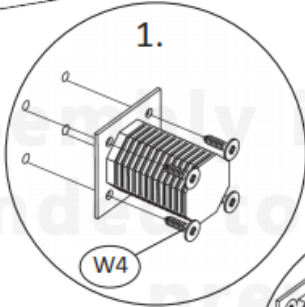
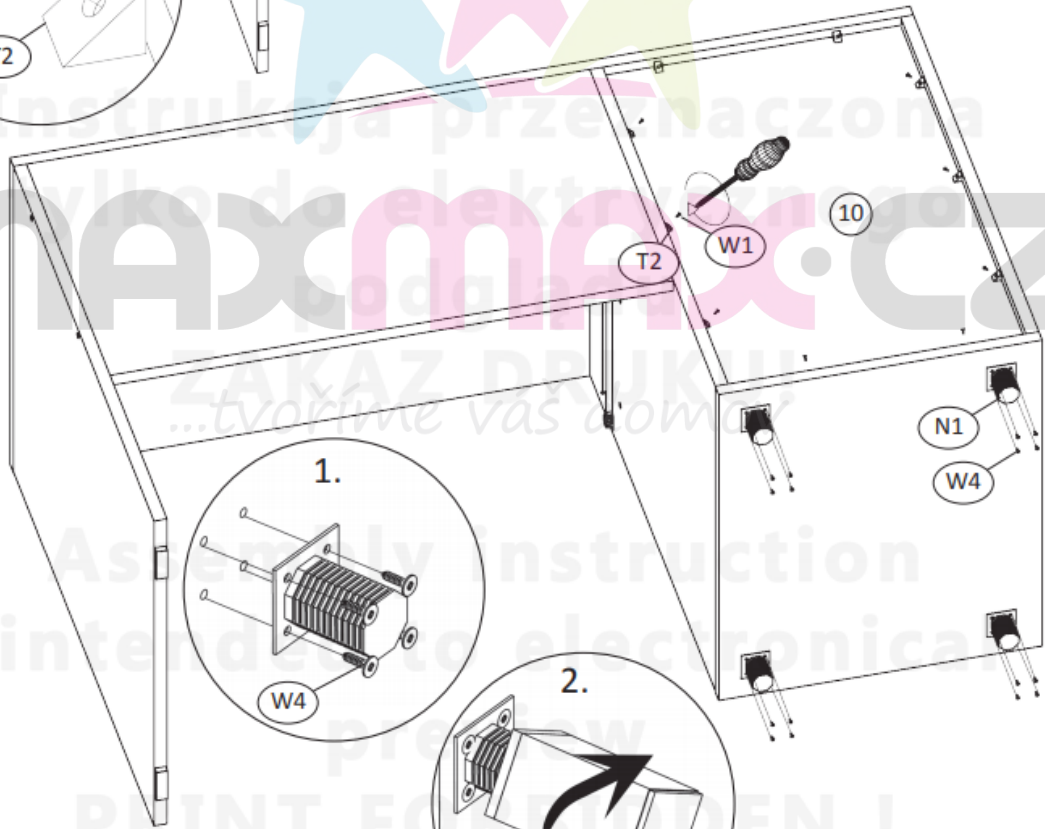
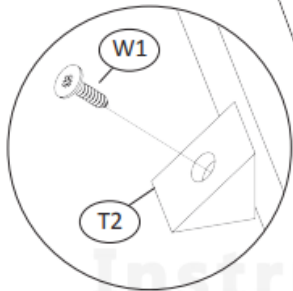

PRINT FOR EASY !

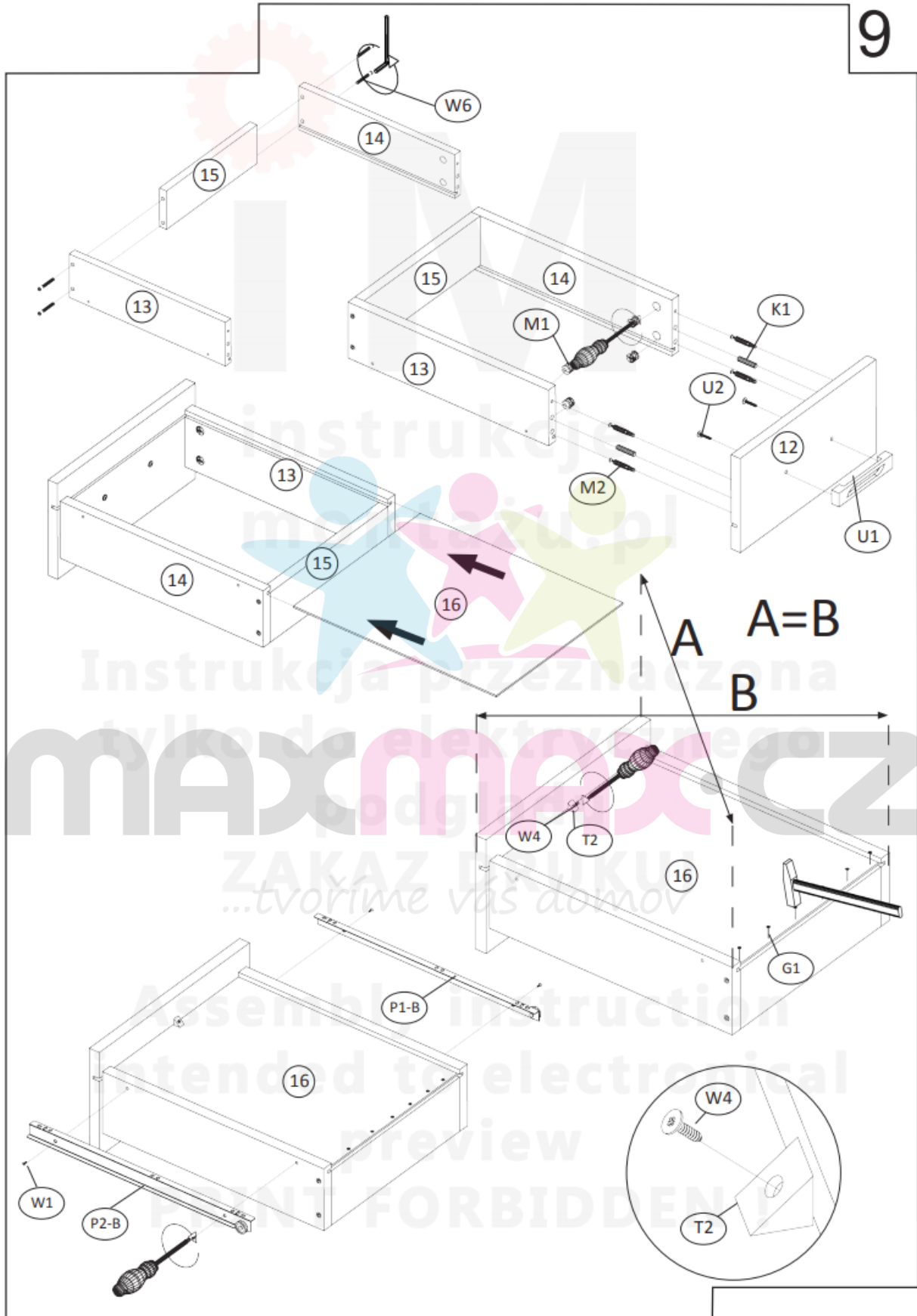

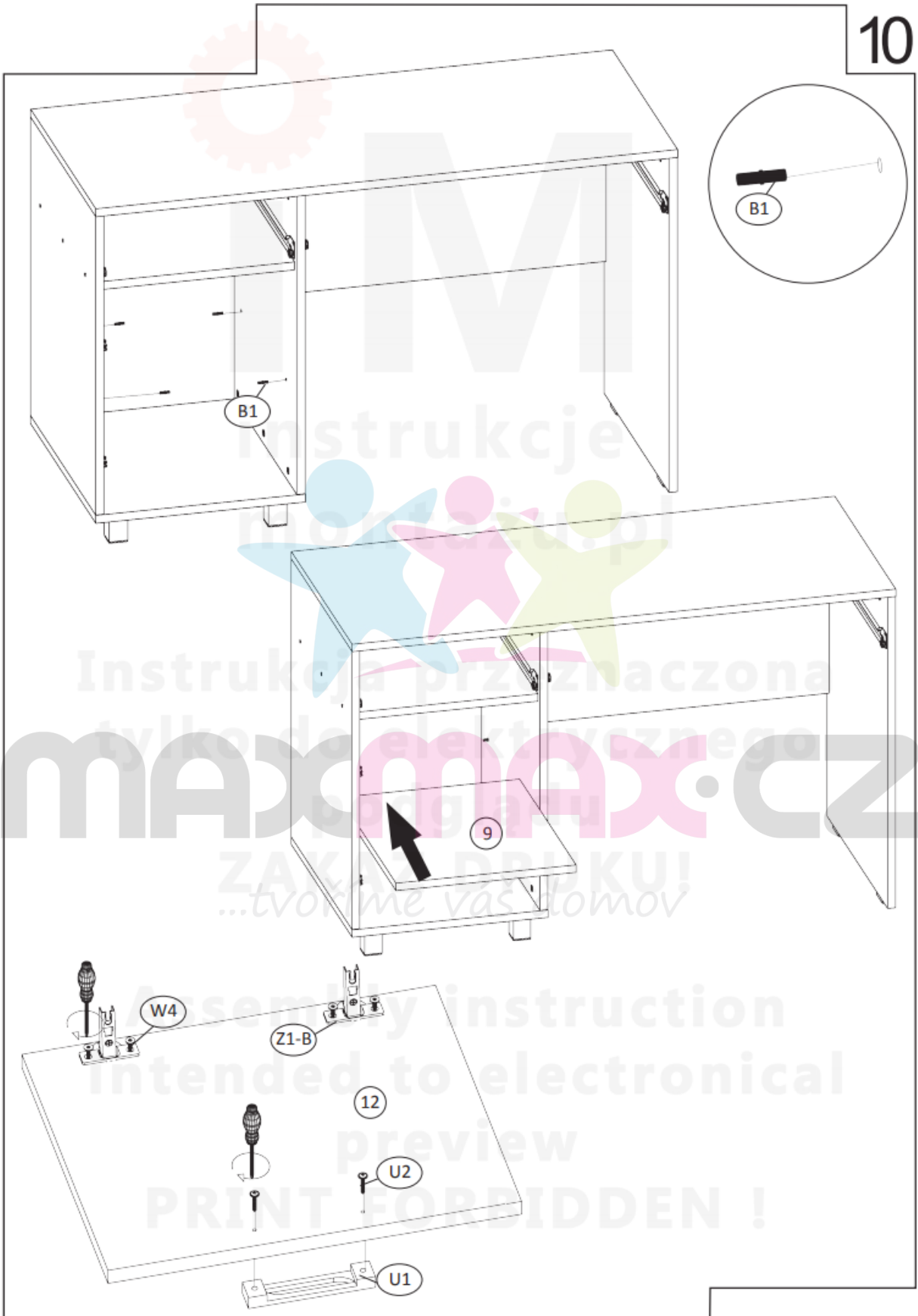

Instrukcja przeznaczona
tylko do elektronicznego
MAXIMAX.CZ
ZAKAZ Drukuj!
...tvoríme váš domov

Assembly instruction
intended to electrical
preview
PRINT FORBIDDEN !

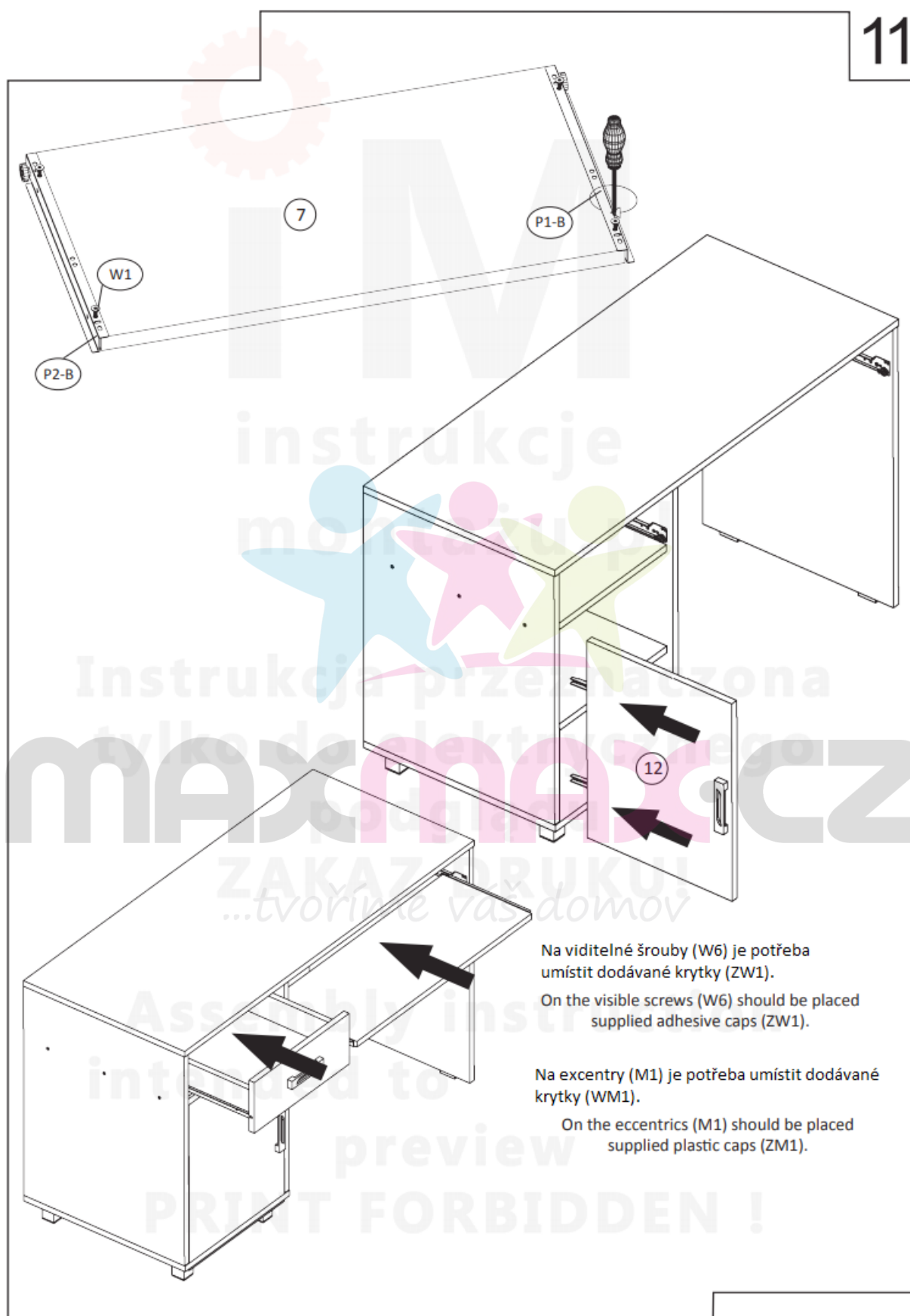

Na viditelné šrouby (W6) je potřeba umístit dodávané krytky (ZW1).

On the visible screws (W6) should be placed supplied adhesive caps (ZW1).

Na excentry (M1) je potřeba umístit dodávané krytky (WM1).

On the eccentrics (M1) should be placed supplied plastic caps (ZM1).

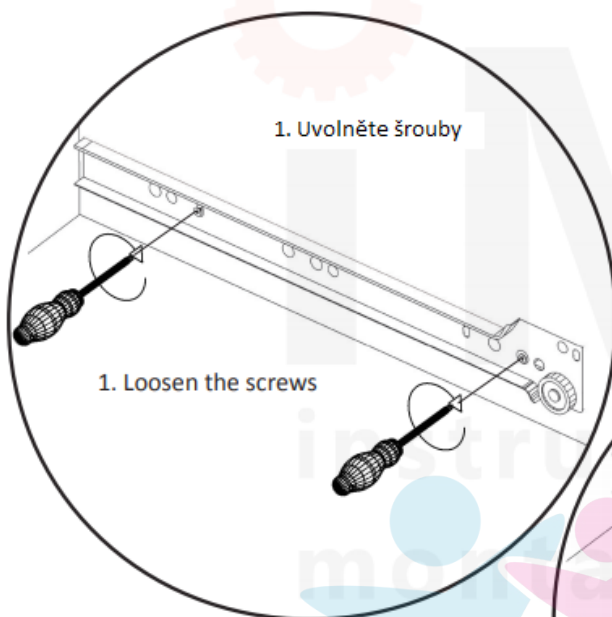

1. Uvolněte šrouby

1. Loosen the screws

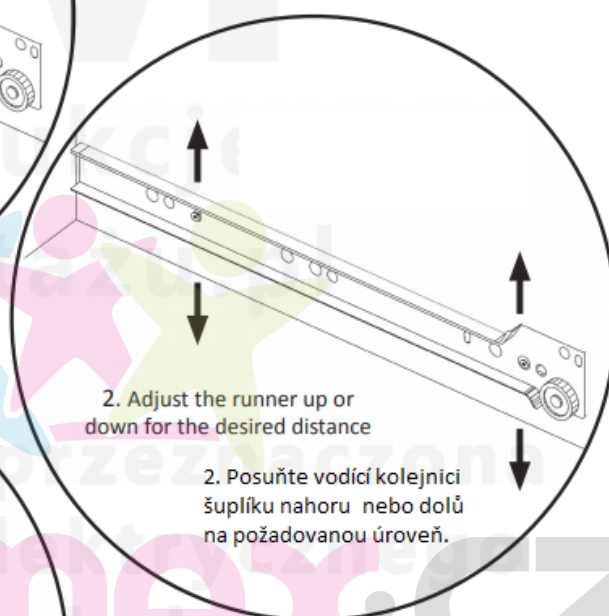

2. Adjust the runner up or down for the desired distance

2. Posuňte vodící kolejnici šuplíku nahoru nebo dolů na požadovanou úroveň.

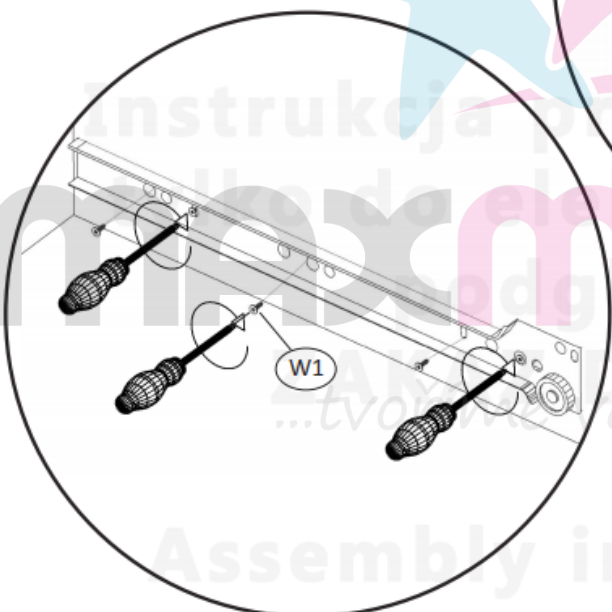

3. Tighten the screws loosened earlier.

3. Utáhněte dříve uvolněné šrouby.

4. Zasuňte zásuvku a zkontrolujte její polohu.

5. Pokud je zásuvka správně umístěna, zašroubujte další tři šrouby pro stabilizaci.

4. Slide the drawer and check their positions.

5. If the drawers are mounted properly tighten another 3 screws to stabilize each drawer runner.

**V případě potřeby opakujte jednotlivé kroky.
If necessary, repeat the steps.**

PRINT FORBIDDEN !