



















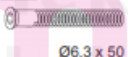





Dětský psací stůl ANIMALS TYP 6 B06

NÁVOD K MONTÁŽI

Příslušenství/ Fittings						
K1  17 ks / pcs	M2  13 ks / pcs	M1  13 ks / pcs	ZM1  13 ks / pcs	ZW1  14 ks / pcs	T2  12 ks / pcs	G1  6 ks / pcs
W1  Ø3 x 16 24 ks / pcs	B1  6 ks / pcs	W4  Ø4 x 16 24 ks / pcs	W6  Ø6,3 x 50 14 ks / pcs	U1  2 ks / pcs	U2  4 ks / pcs	N1  4 ks / pcs
P1-A  500 mm 1 ks / pcs	P1-B  500 mm 1 ks / pcs	P2-A  500 mm 1 ks / pcs	P2-B  500 mm 1 ks / pcs	S1  2 ks / pcs	Z1-A  2 ks / pcs	Z1-B  2 ks / pcs
P5-A  300 mm 1 ks / pcs	P5-B  300 mm 1 ks / pcs	P6-A  300 mm 1 ks / pcs	P5-B  300 mm 1 ks / pcs			

Nástroje / Tools		
		

MONTÁŽ STOLU JE MOŽNÁ POUZE VE DVOU OSOBÁCH

**VELMI DŮLEŽITÉ!
ČTĚTE PEČLIVĚ
NÁVOD SI ULOŽTE PRO POZDĚJŠÍ POUŽITÍ
UŽIVATELSKÁ PŘÍRUČKA**

1.
Všecky obalový materiál odstraňte mimo dosah dětí, tak aby nemohlo dojít k udušení nebo uškrcení.
2.
Všechny spoje musí být řádně dotaženy, žádná součástka nesmí zůstat volná.
3.
Nábytek nepoužívejte v případě, že je nějaká součástka poškozená, či chybí.
4.
Používejte pouze součástky dodané výrobcem.
5.
Nepokládejte nábytek do blízkosti otevřeného ohně nebo k jiným zdrojům tepla, jako je elektrické nebo plynové topení apod., mohlo by dojít ke vznícení.

**VERY IMPORTANT!
PLEASE READ CAREFULLY
SAVE FOR FUTURE USE**

USER'S MANUAL

1.
To avoid the danger of choking or strangulation keep the package with fittings away from babies and children.
2.
All connections must be tightened properly and no coupled element can not be loose.
3.
Do not use the bed when, if any of the elements is damaged or if there is any element missing.
4.
Use only the elements given by manufacturer.
5.
Do not place the bed near naked flames or other heat sources such as electric or gas radiators etc., this may cause a fire.

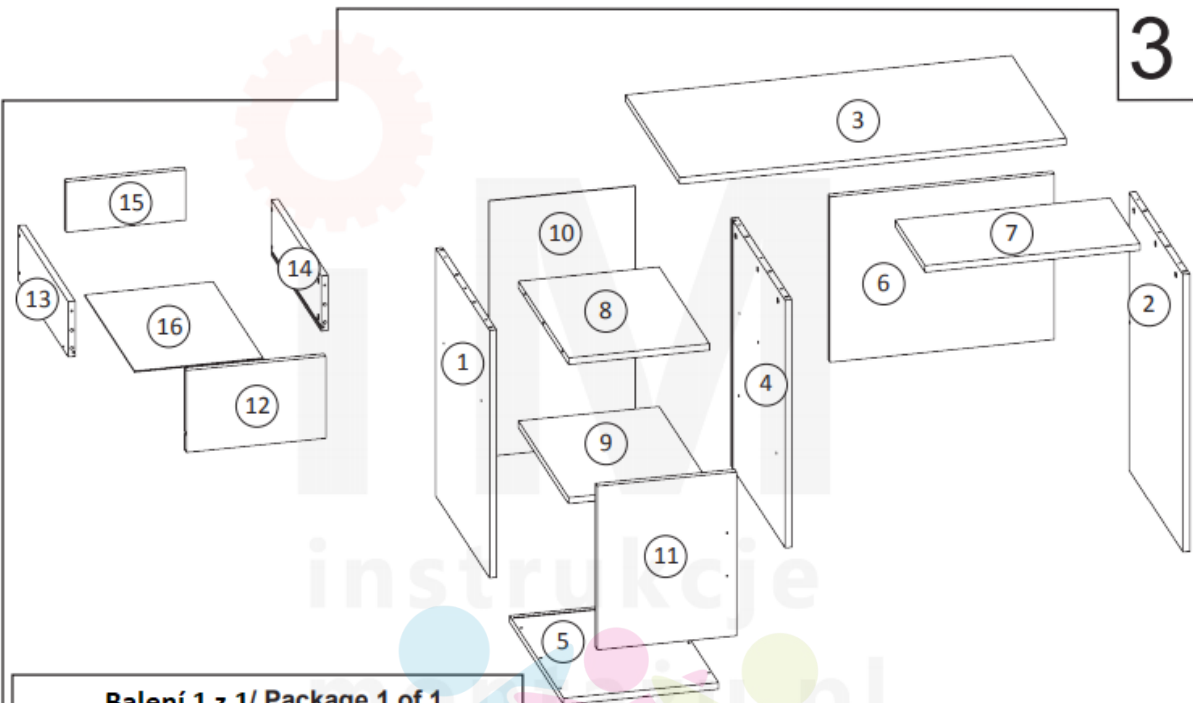
Balení 1 z 1/ Package 1 of 1

Číslo položky / item no.	Rozměry (mm) / Dimensions (mm)	Počet / Quantity
1	674 x 598 x 18	1
2	752 x 598 x 18	1
3	1002 x 600 x 18	1
4	674 x 598 x 18	1
5	402 x 600 x 18	1
6	582 x 450 x 18	1
7	557 x 300 x 18	1
8	364 x 565 x 18	1
9	364 x 555 x 18	1
10	382 x 692 x 3	1
11	360 x 447 x 18	1
12	360 x 223 x 18	1
13	500 x 180 x 18	1
14	500 x 180 x 18	1
15	303 x 162 x 18	1
16	321 x 504 x 3	1

Před montáží se ujistěte, že balení obsahuje všechny položky uvedené na této stránce a zkontrolujte, jestli žádná z položek není poškozena. V případě, že některá z položek chybí nebo jeví známky poškození, kontaktujte prodejce tohoto výrobku.

BEFORE ASSEMBLING THE FURNITURE PLEASE CHECK THAT PACKAGES INCLUDE ALL ITEMS LISTED IN THE TABLE ON PAGE NO 3, AND WHETHER THESE ITEMS ARE NOT DAMAGED !!!
IF MISSING PARTS OR SOME OF THEM ARE DAMAGED, PLEASE CONTACT OUR CUSTOMER SERVICE OFFICE.
DAMAGES FOUND AFTER ASSEMBLING WILL NOT BE CONSIDERED !!!

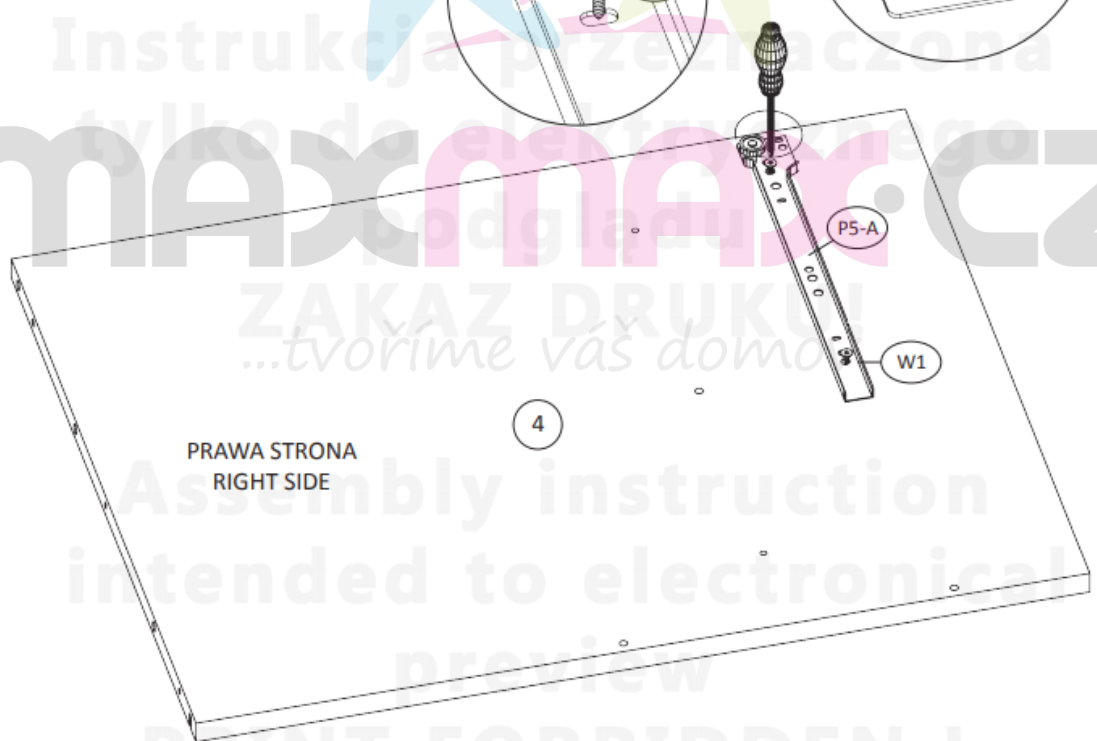
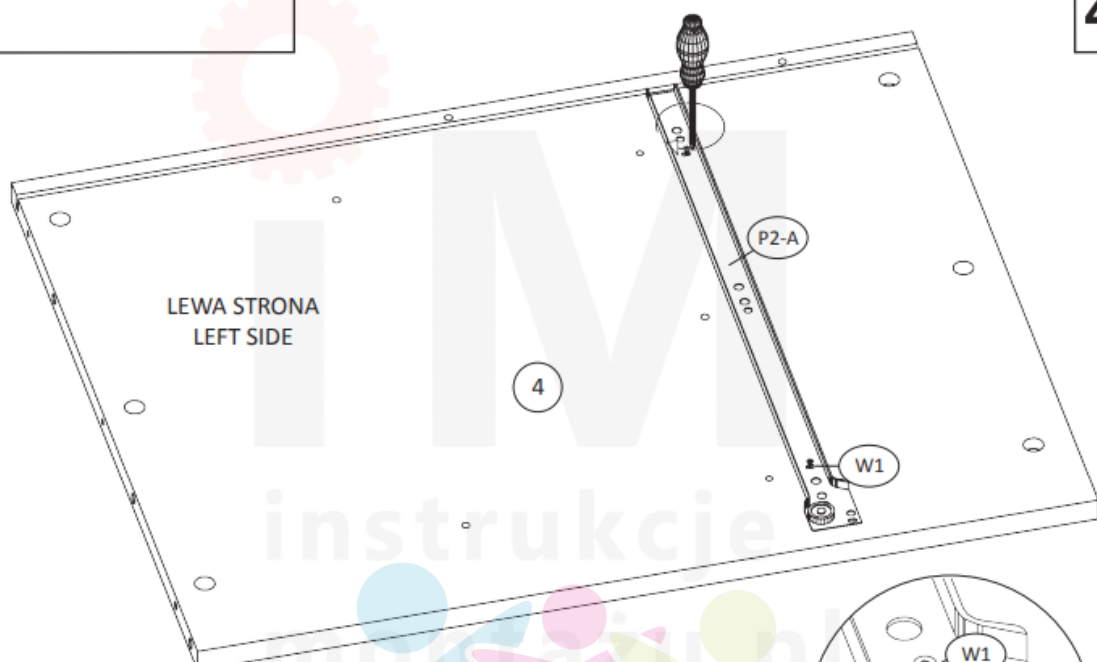

instrukcje
maks
Instrukcja przeznaczona
tylko do elektronicznego
podglądu
MAXMAX.CZ
ZAKAZ DRUKU
...tvoríme váš domo
Assembly instruction
intended to electrical
preview
PRINT FORBIDDEN !

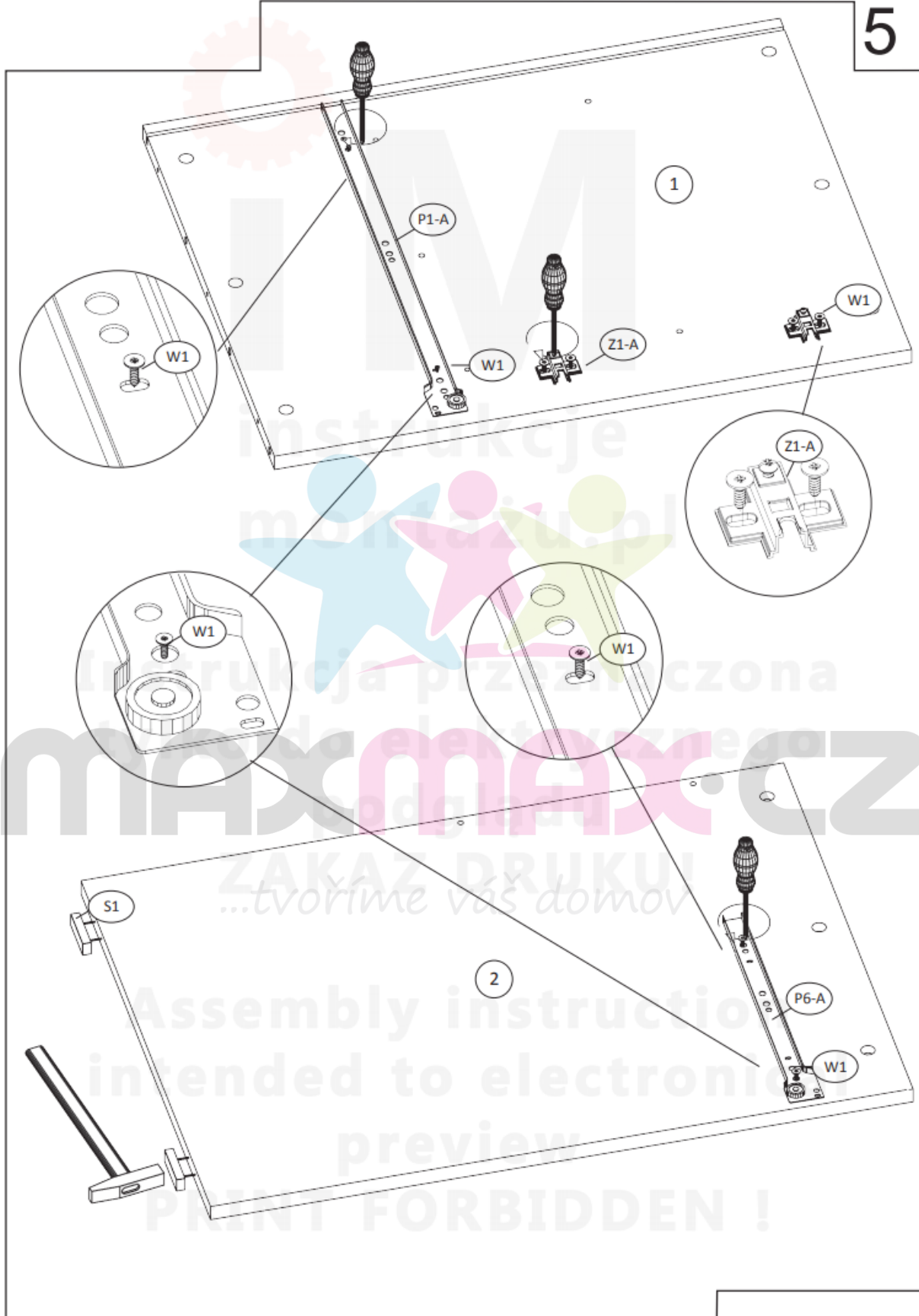

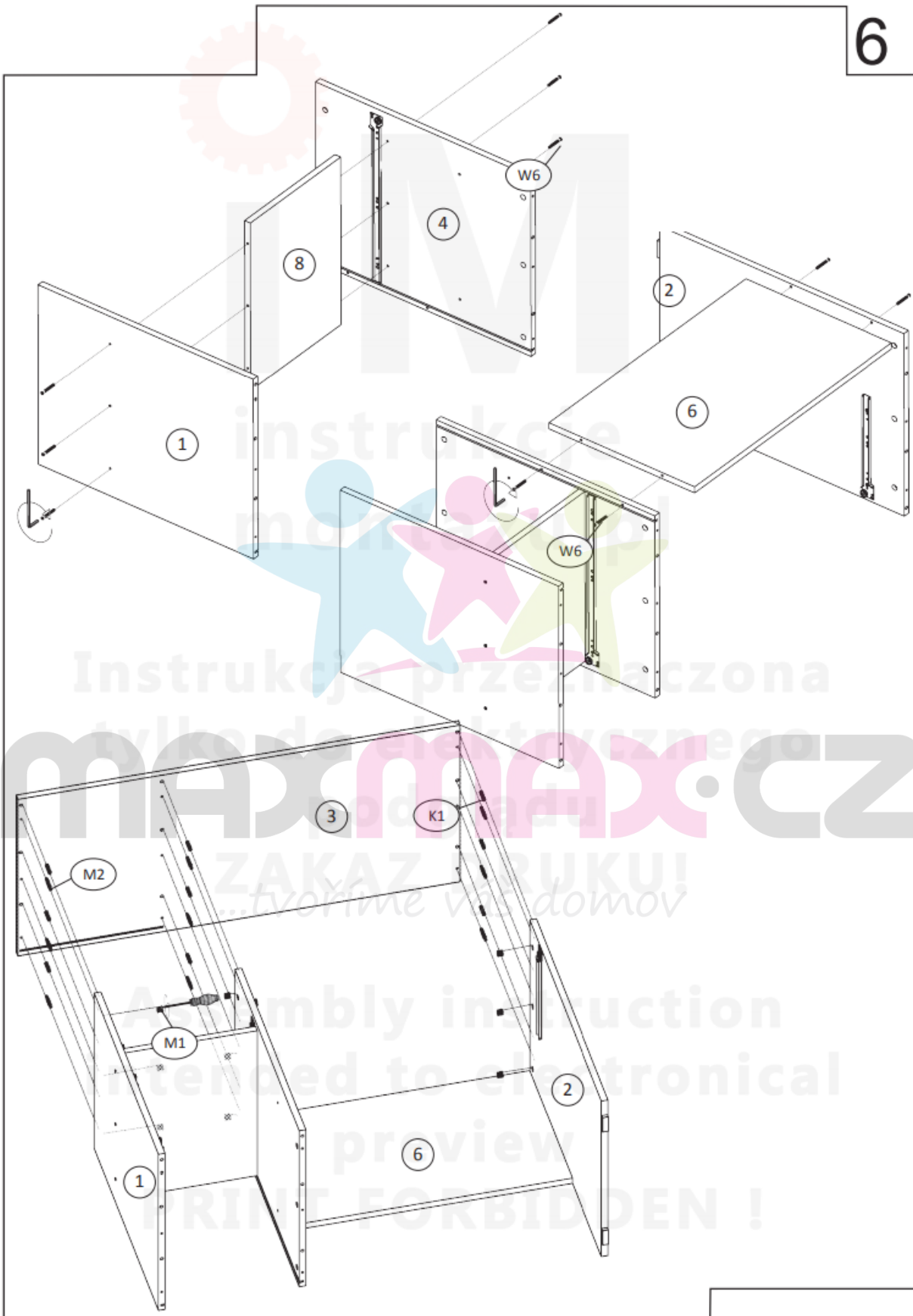

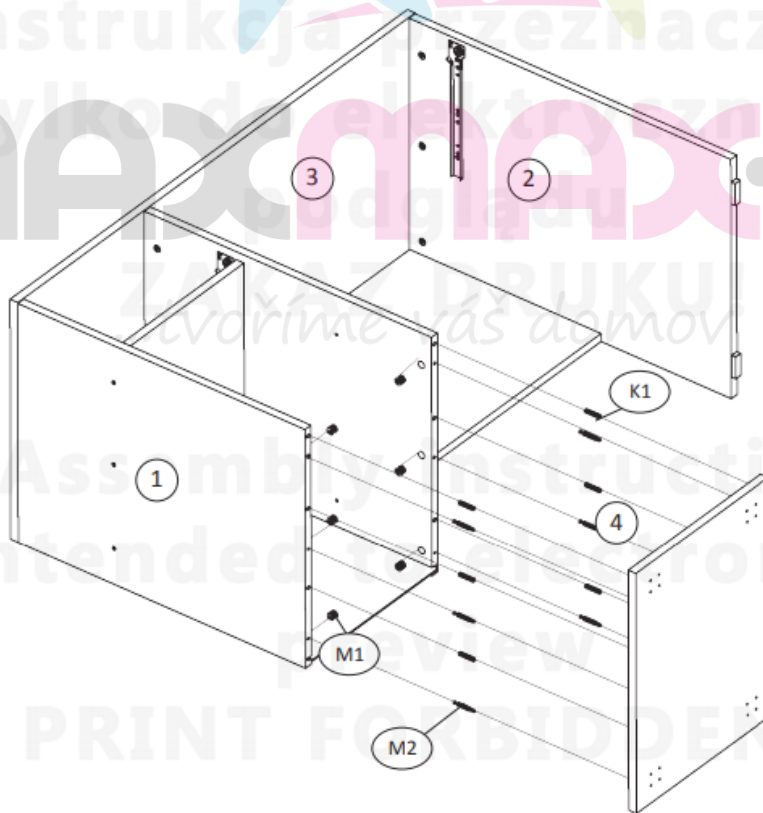
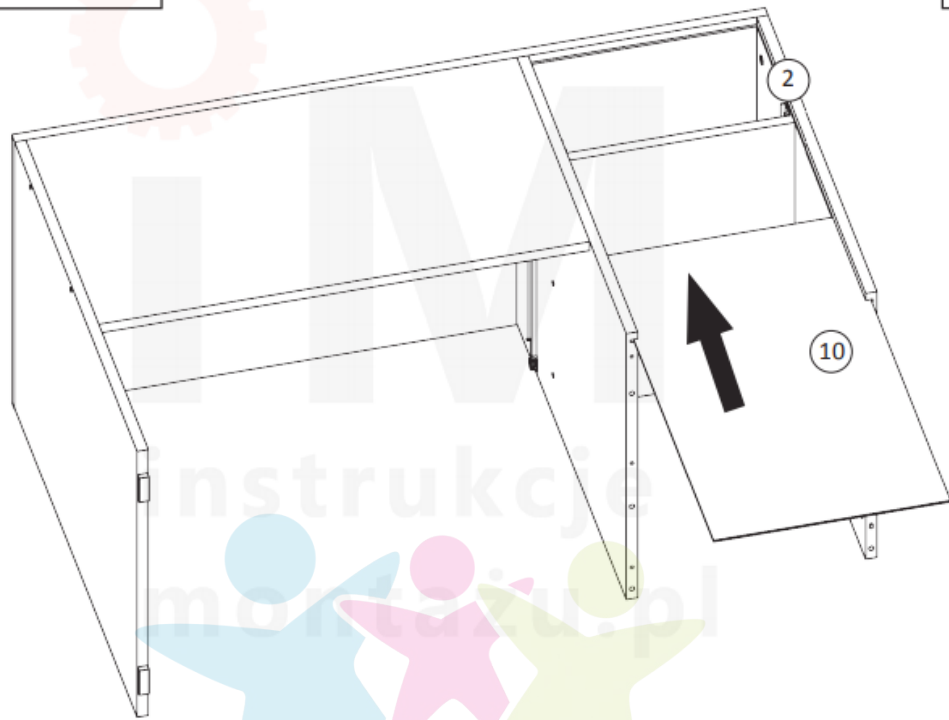

Assembly instruction
intended for electronic
review
PRINT FORBIDDEN!

A=B

A

B

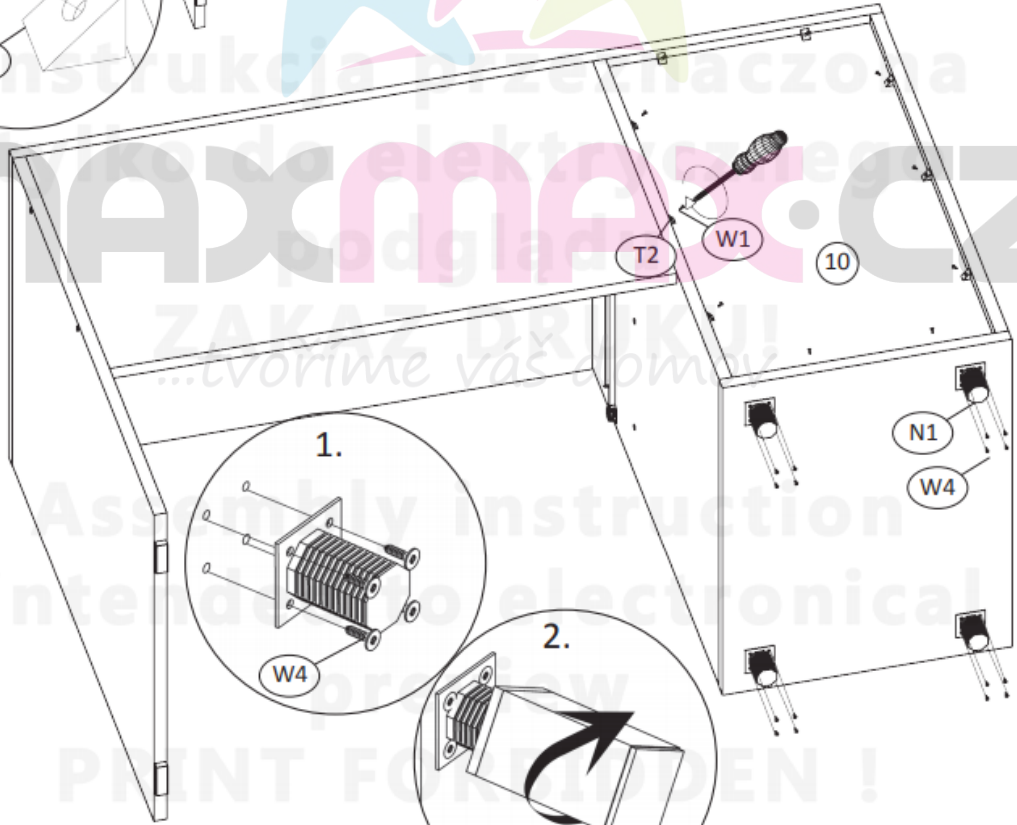
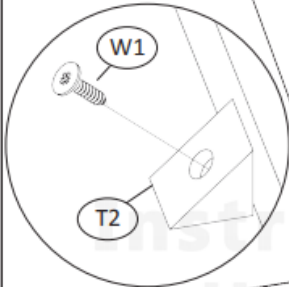

instrukcije
montažni
instrukcia pretnacova
kako da elektricne
podglac
MAXMA.CZ
ZAKAZ DRUKU!
...vovime vas dom
Assembly instruction
intende pro
PRINT FORBIDDEN!

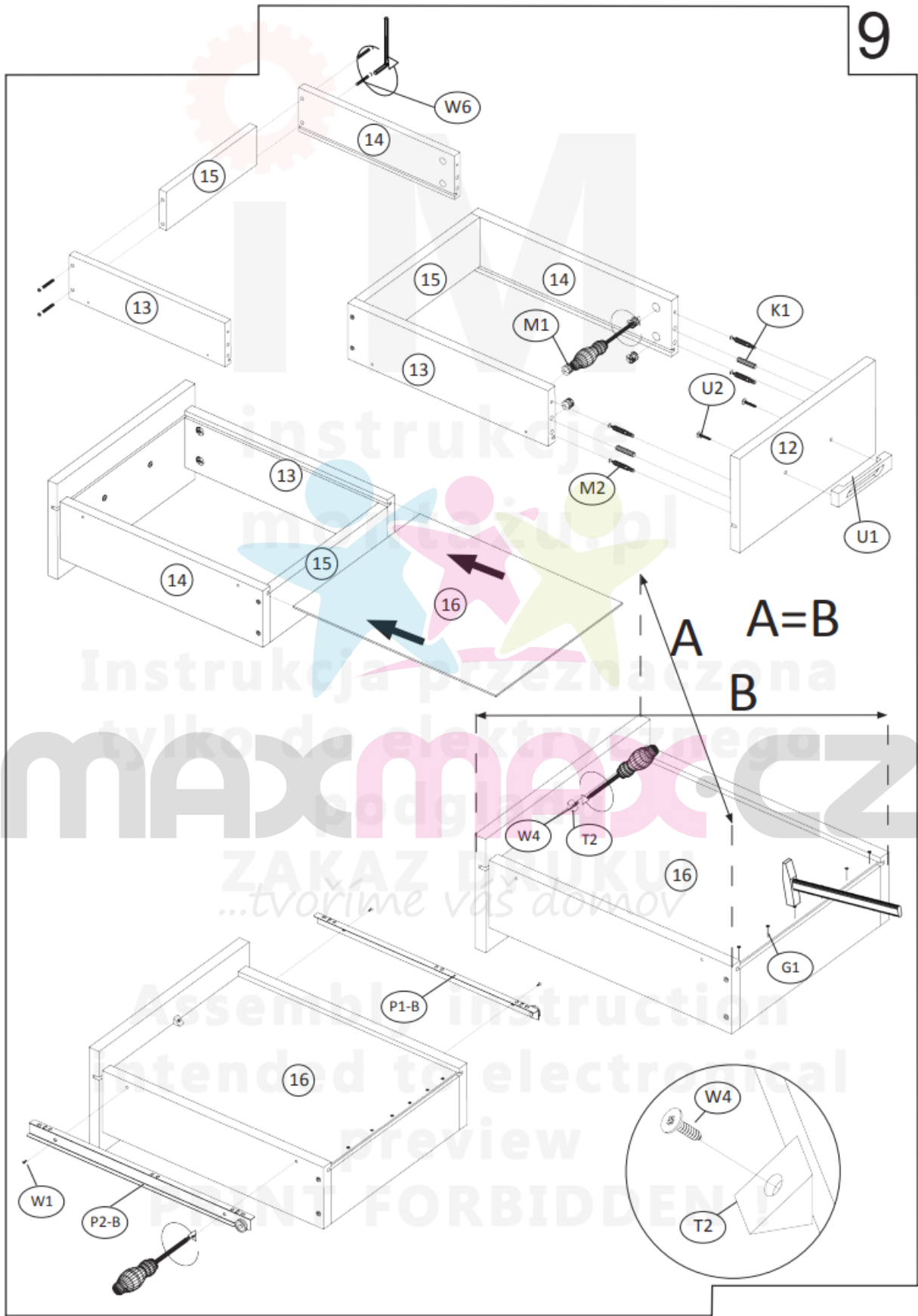

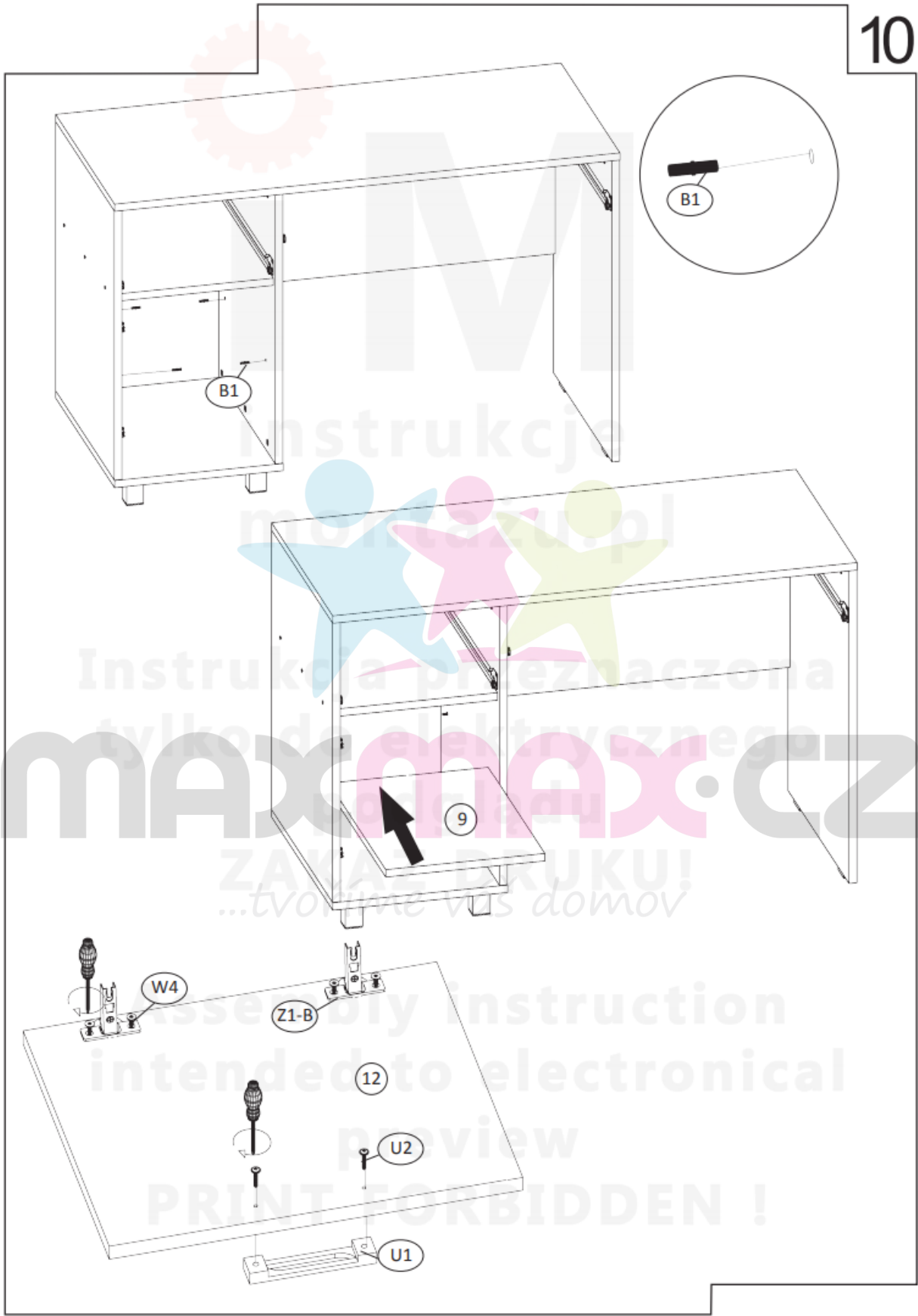

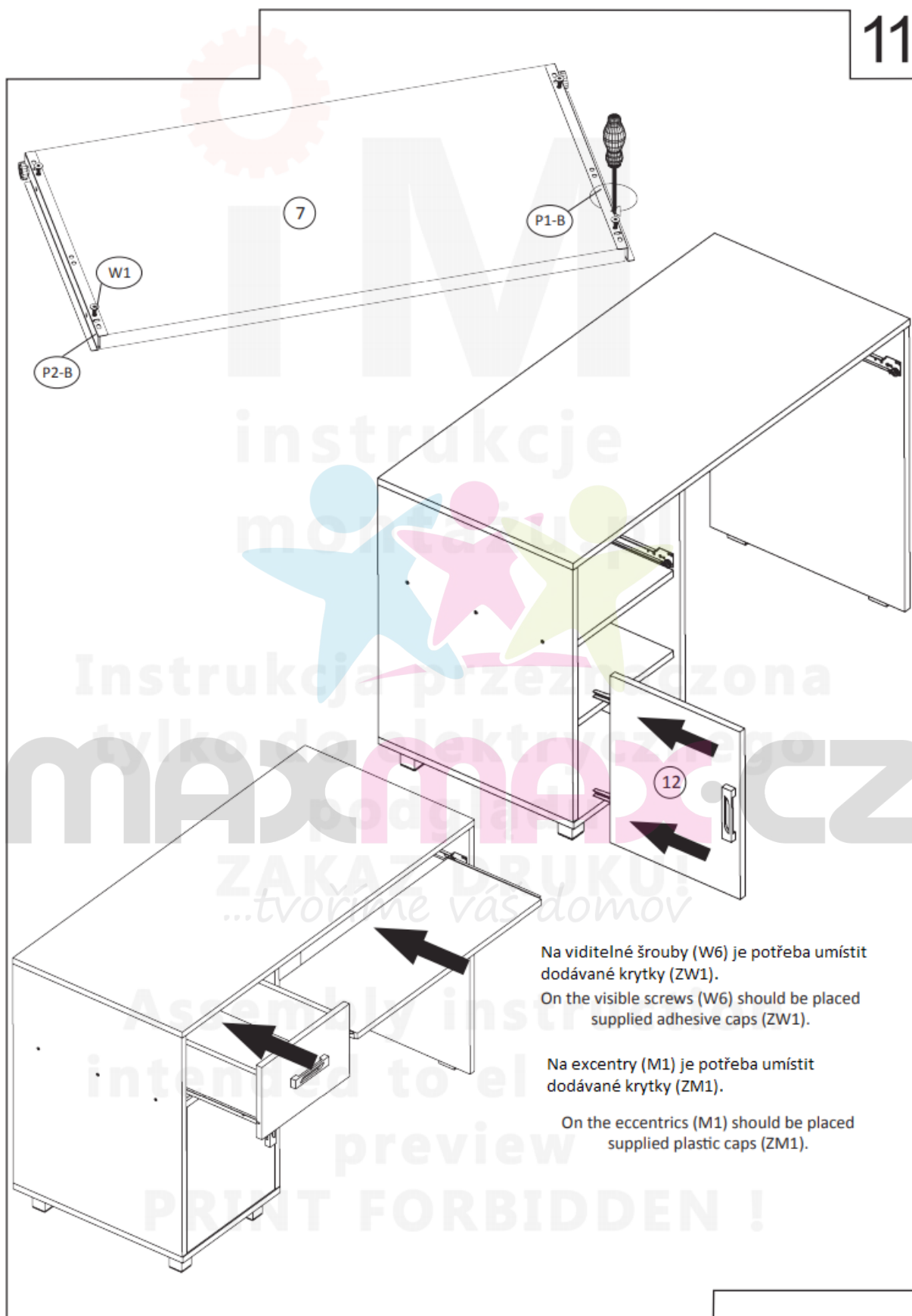

Na viditelné šrouby (W6) je potřeba umístit dodávané krytky (ZW1).

On the visible screws (W6) should be placed supplied adhesive caps (ZW1).

Na excentry (M1) je potřeba umístit dodávané krytky (ZM1).

On the eccentrics (M1) should be placed supplied plastic caps (ZM1).

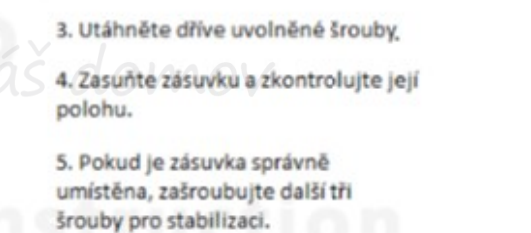
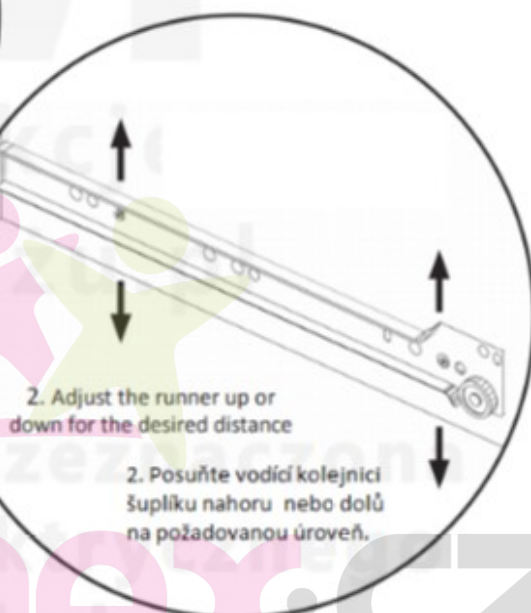
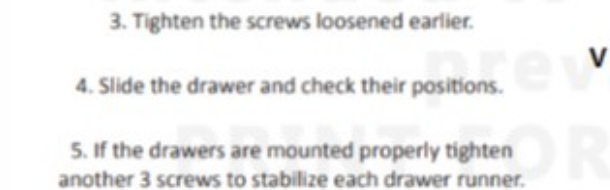
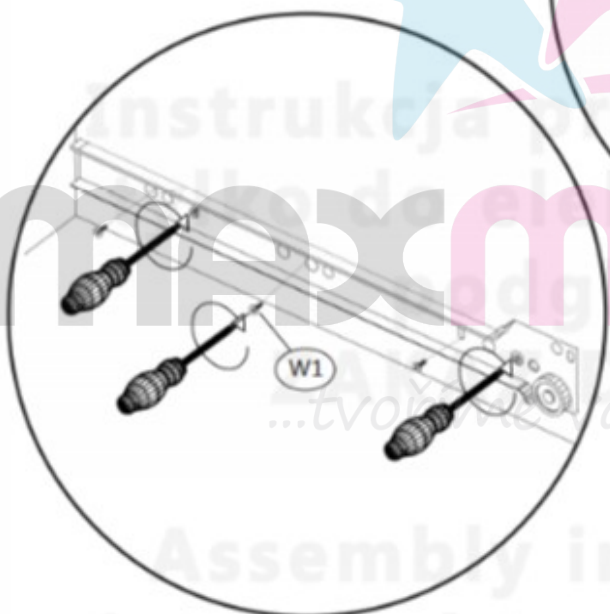
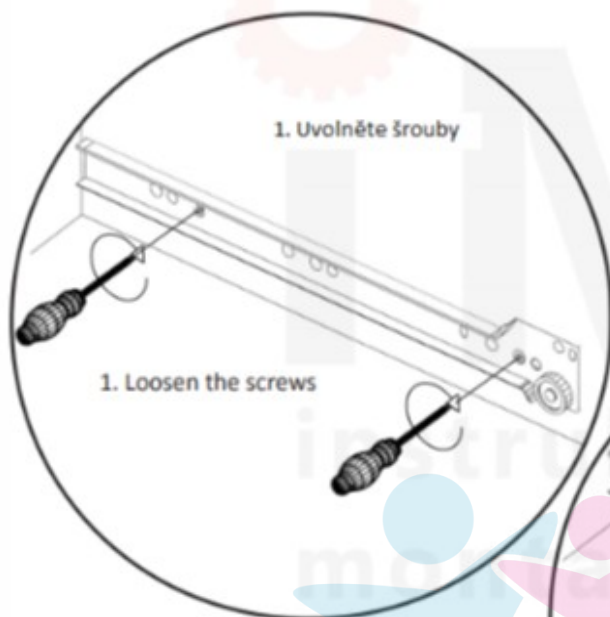

4. Slide the drawer and check their positions.
5. If the drawers are mounted properly tighten another 3 screws to stabilize each drawer runner.

**V případě potřeby opakujte jednotlivé kroky.
If necessary, repeat the steps.**

Assembly instruction intended to electrical prev. PRINT FORBIDDEN !