





















Dětská komoda ANIMALS TYP 8 K08

NÁVOD K MONTÁŽI

Příslušenství / Fittings						
 K1	 M2	 M1	 ZM1	 ZW1	 T2	 G1
22 ks / pcs	30 ks / pcs	30 ks / pcs	30 ks / pcs	20 ks / pcs	16 ks / pcs	25 ks / pcs
 W1	 B1	 W4	 W6	 U1	 U2	 N1
Ø3 x 16 48 ks / pcs	12 ks / pcs	Ø4 x 16 28 ks / pcs	Ø6,3 x 50 10 ks / pcs	5 ks / pcs	10 ks / pcs	4 ks / pcs
 P1-A	 P1-B	 P2-A	 P2-B	 T1	 Z1-A	 Z1-B
400mm 4 ks / pcs	400mm 4 ks / pcs	400mm 4 ks / pcs	400mm 4 ks / pcs	5 ks / pcs	2 ks / pcs	2 ks / pcs

Nástroje / Tools		
		

MONTÁŽ KOMDY JE MOŽNÁ POUZE VE DVOU OSOBÁCH

**VELMI DŮLEŽITÉ!
ČTĚTE PEČLIVĚ
NÁVOD SI ULOŽTE PRO POZDĚJŠÍ POUŽITÍ
UŽIVATELSKÁ PŘÍRUČKA**

1.
Veškerý obalový materiál odstraňte mimo dosah dětí, tak aby nemohlo dojít k udušení nebo uškrcení.

2.
Všechny spoje musí být řádně dotaženy, žádná součástka nesmí zůstat volná.

3.
Nábytek nepoužívejte v případě, že je nějaká součástka poškozená, či chybí.

4.
Používejte pouze součástky dodané výrobcem.

5.
Nepokládejte nábytek do blízkosti otevřeného ohně nebo k jiným zdrojům tepla, jako je elektrické nebo plynové topení apod., mohlo by dojít ke vznícení.

**VERY IMPORTANT!
PLEASE READ CAREFULLY
SAVE FOR FUTURE USE
USER'S MANUAL**

1.
To avoid the danger of choking or strangulation keep the package with fittings away from babies and children.

2.
All connections must be tightened properly and no coupled element can not be loose.

3.
Do not use the bed when, if any of the elements is damaged or if there is any element missing.

4.
Use only the elements given by manufacturer.

5.
Do not place the bed near naked flames or other heat sources such as electric or gas radiators etc., this may cause a fire.

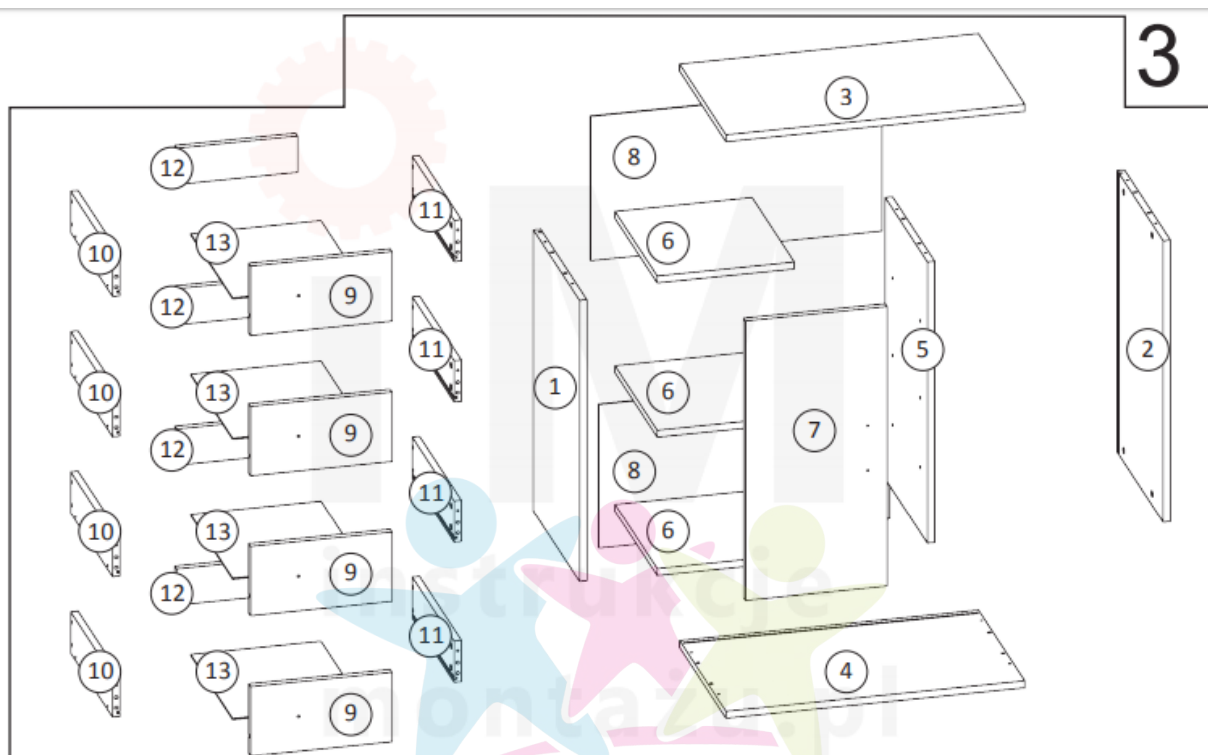

Balení 1 z 1/ Package 1 of 1

Číslo položky / item no.	Rozměry (mm) / Dimensions (mm)	Počet / Quantity
1	760 x 440 x 18	1
2	760 x 440 x 18	1
3	884 x 442 x 18	1
4	884 x 442 x 18	1
5	760 x 407 x 18	1
6	414 x 397 x 18	3
7	420 x 358 x 18	1
8	778 x 431 x 3	2
9	420 x 188 x 18	4
10	400 x 138 x 18	4
11	400 x 138 x 18	4
12	353 x 120 x 18	4
13	371 x 404 x 3	4

Před montáží se ujistěte, že balení obsahuje všechny položky uvedené na této stránce a zkontrolujte, jestli žádná z položek není poškozena. V případě, že některá z položek chybí nebo jeví známky poškození, kontaktujte prodejce tohoto výrobku.

BEFORE ASSEMBLING THE FURNITURE PLEASE CHECK THAT PACKAGES INCLUDE ALL ITEMS LISTED IN THE TABLE ON PAGE NO 3, AND WHETHER THESE ITEMS ARE NOT DAMAGED !!!

IF MISSING PARTS OR SOME OF THEM ARE DAMAGED, PLEASE CONTACT OUR CUSTOMER SERVICE OFFICE. DAMAGES FOUND AFTER ASSEMBLING WILL NOT BE CONSIDERED !!!

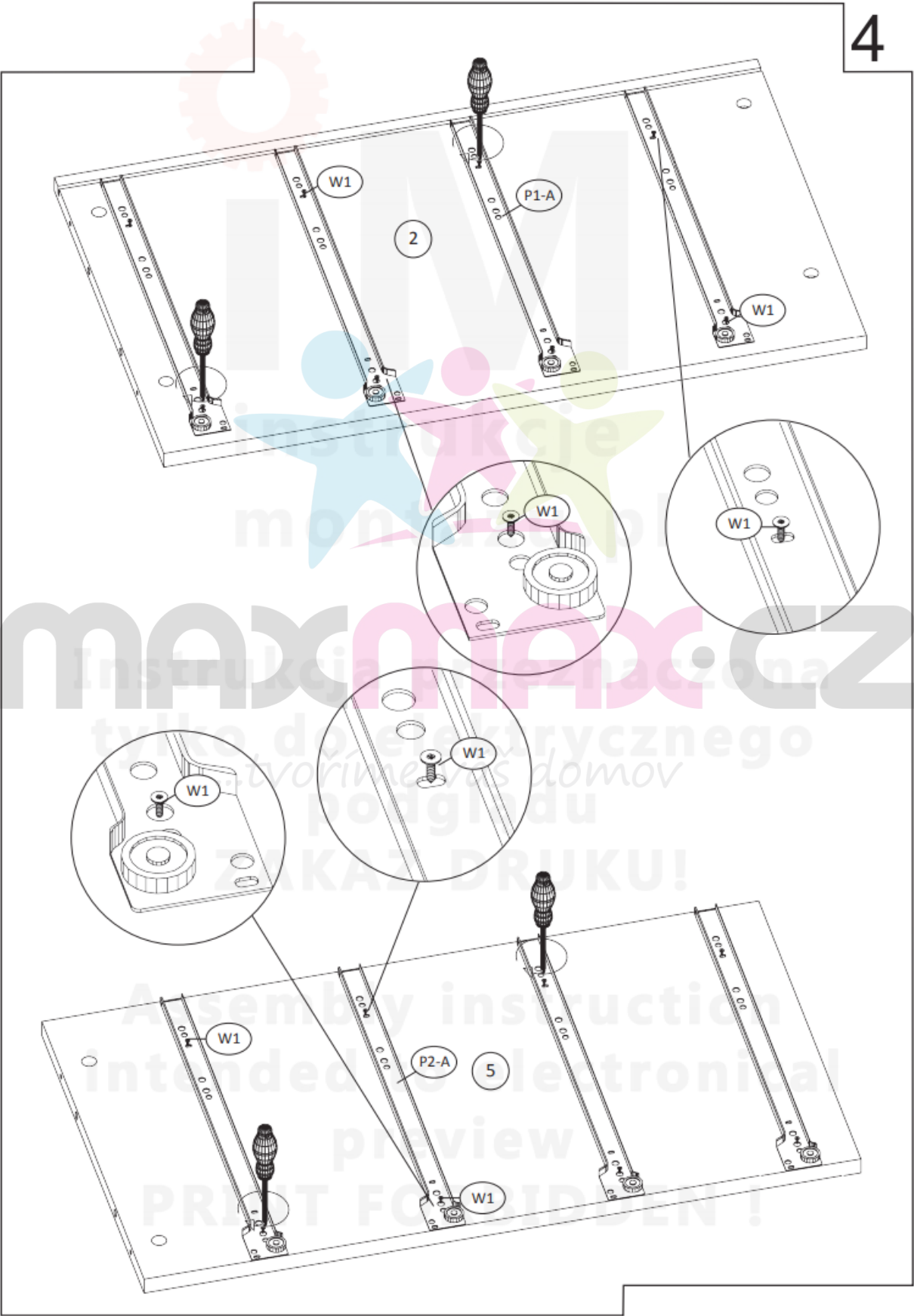

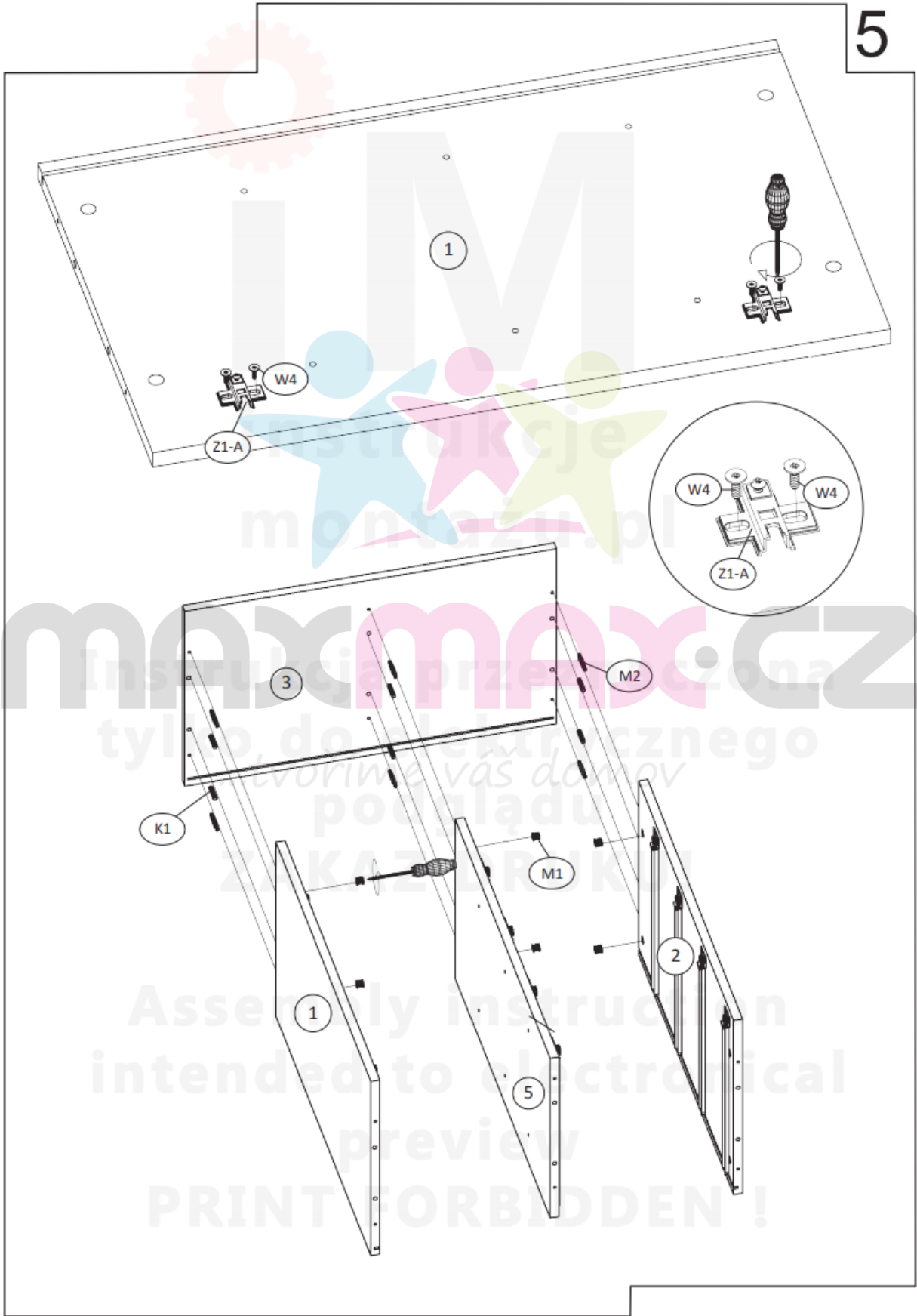

6

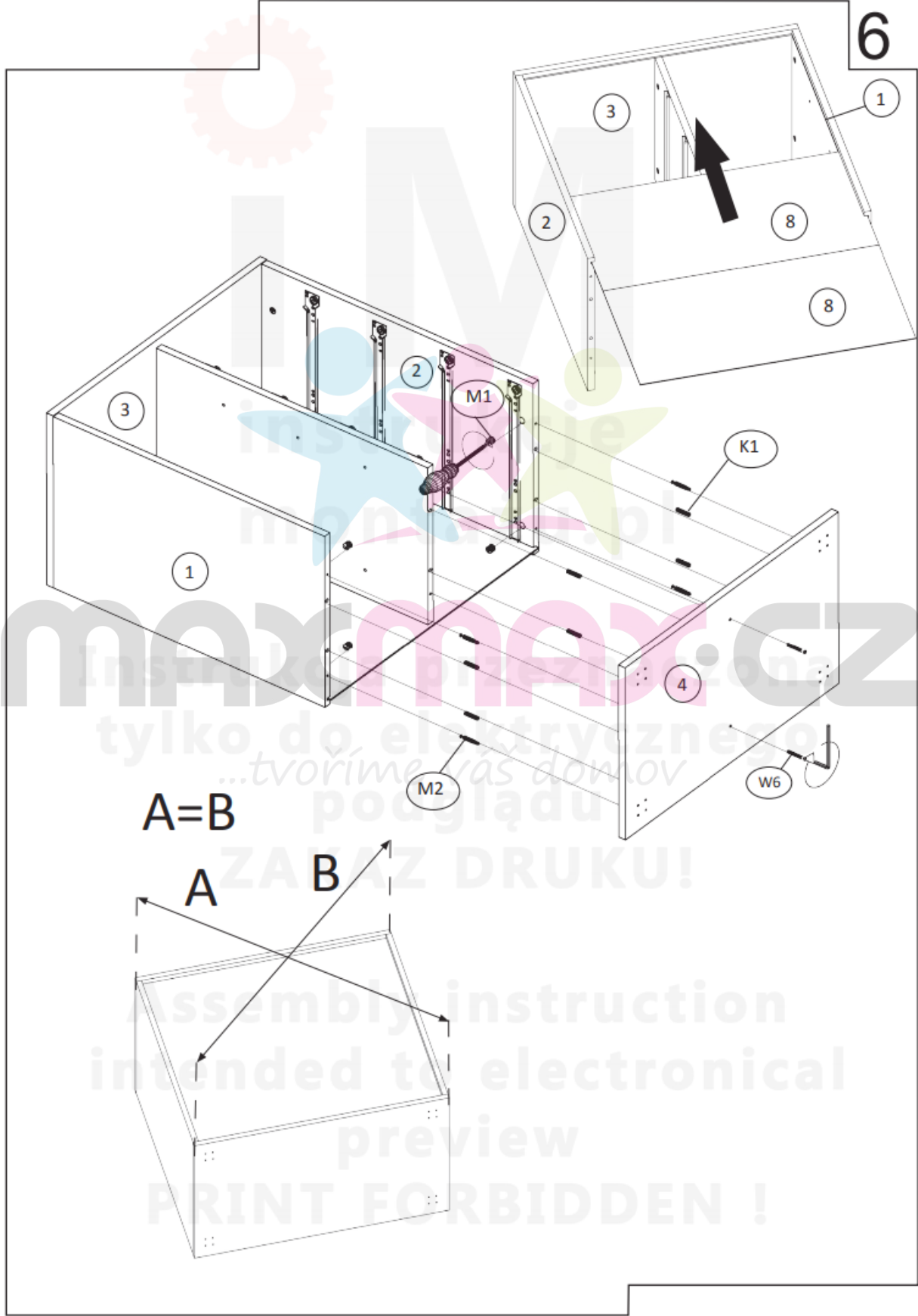

$A=B$

A

B

Assembly instruction
intended to be an
electronic
preview
PRINT FORBIDDEN !

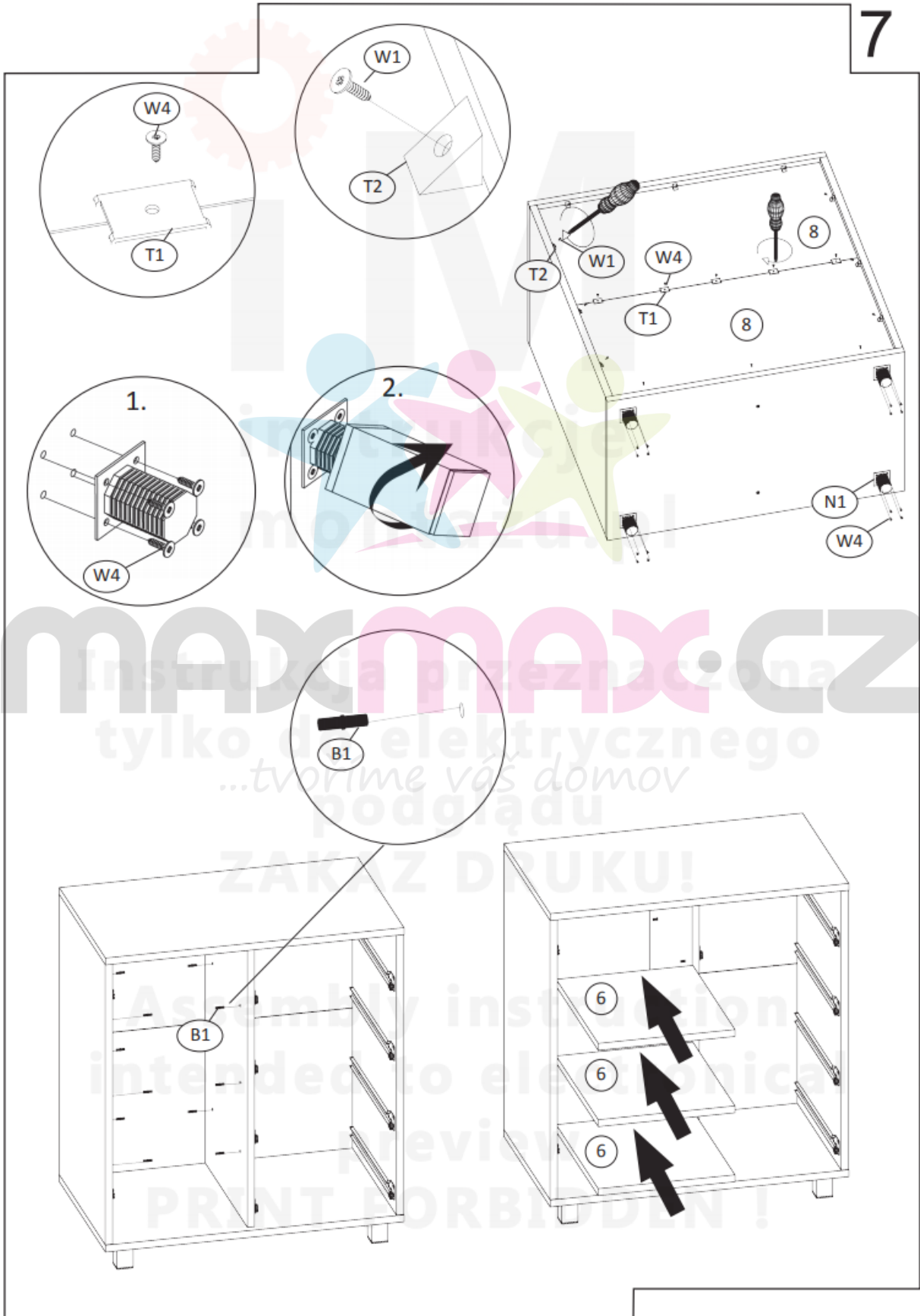

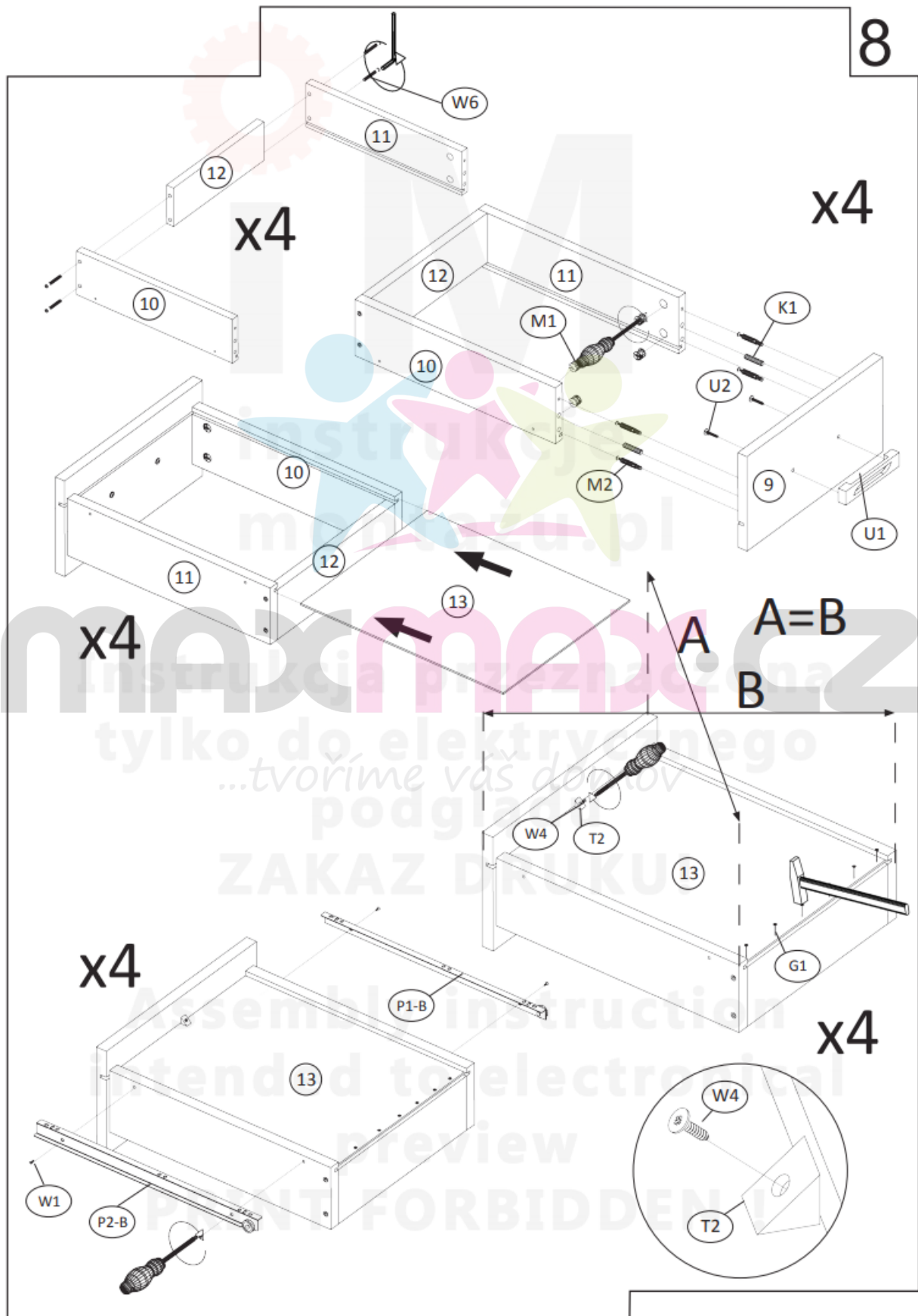

instrukcja przez
m
tylko do elektrycznego
...tworíme vaš domov
podgląd
ZAKAZ DRUKU
Assembly instruction
intended to electrical
preview
PRINT FORBIDDEN!

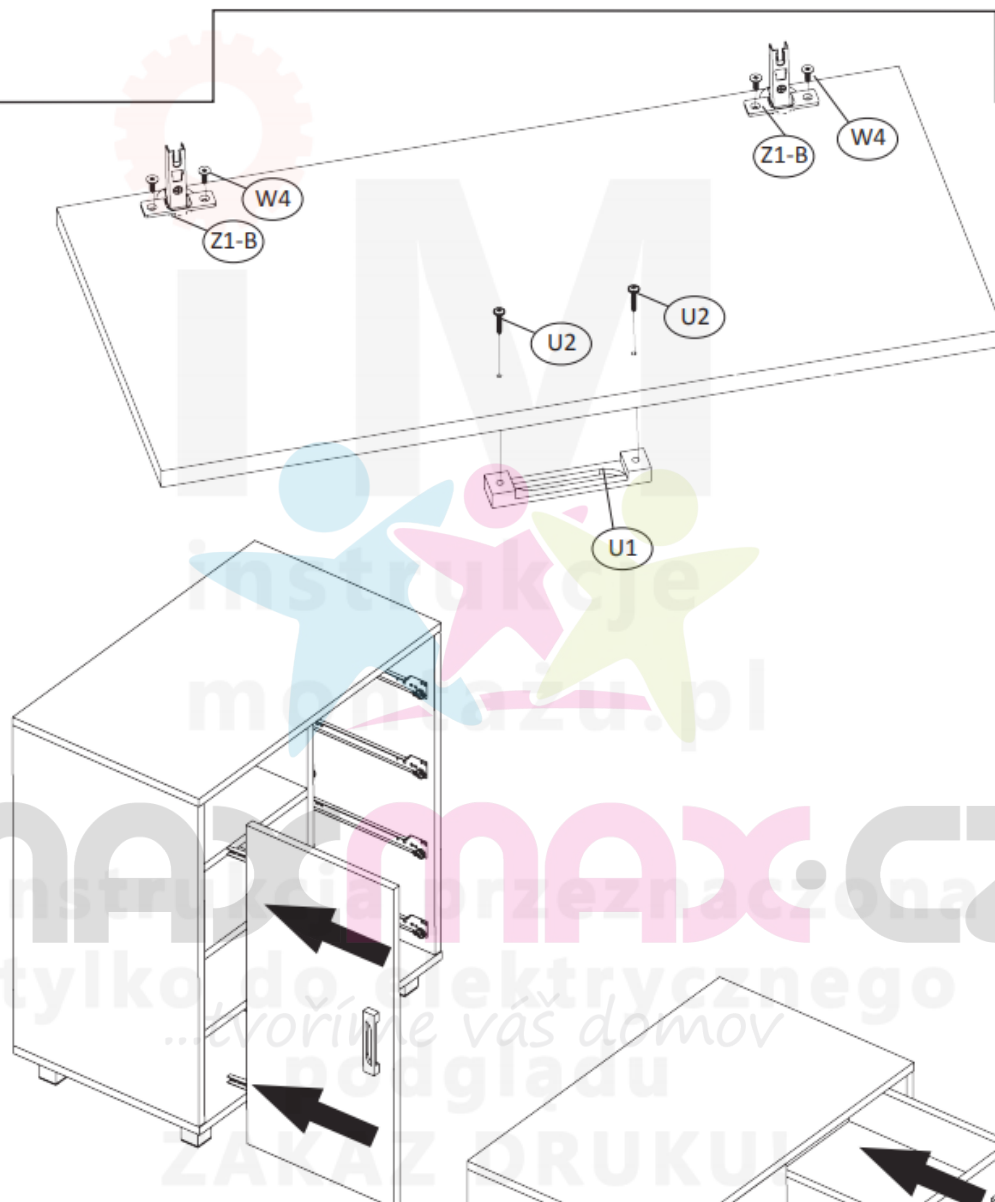

Na viditelné šrouby (W6) je potřeba umístit
dodávané krytky (ZW1).

On the visible screws (W6) should be placed
supplied adhesive caps (ZW1).

Na excentry (M1) je potřeba umístit
dodávané krytky (ZM1).

On the eccentrics (M1) should be placed
supplied plastic caps (ZM1).

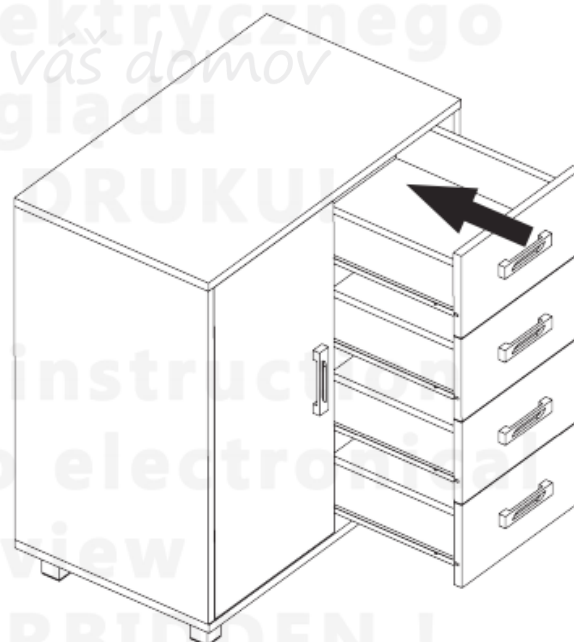

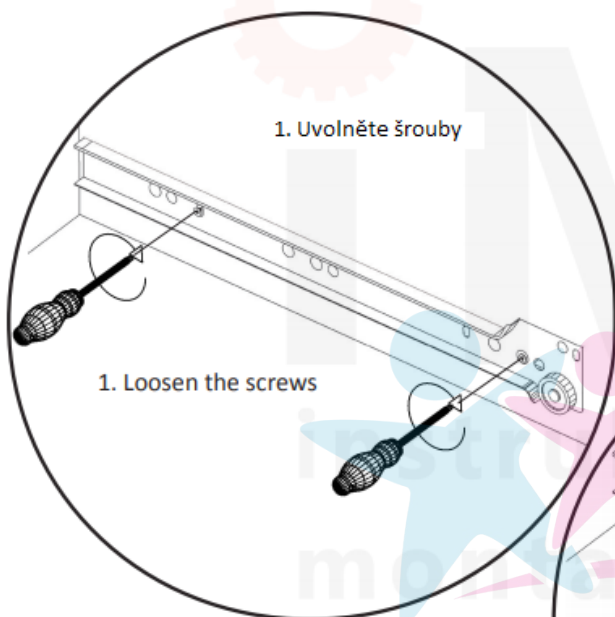

1. Uvolněte šrouby

1. Loosen the screws

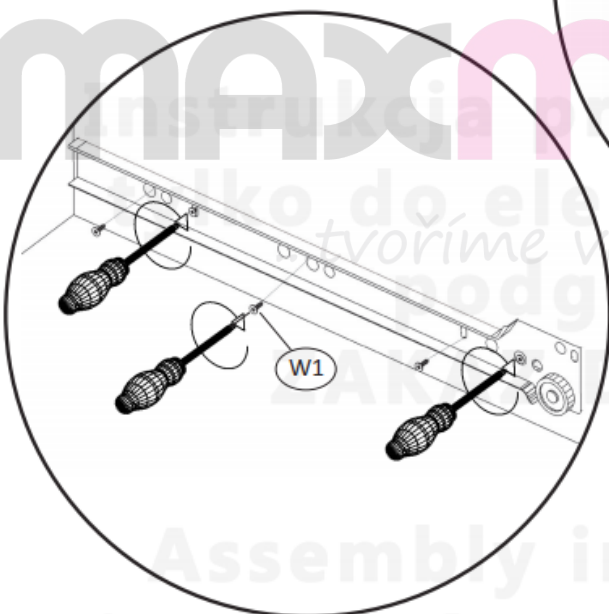

3. Tighten the screws loosened earlier.

4. Slide the drawer and check their positions.

5. If the drawers are mounted properly tighten another 3 screws to stabilize each drawer runner.

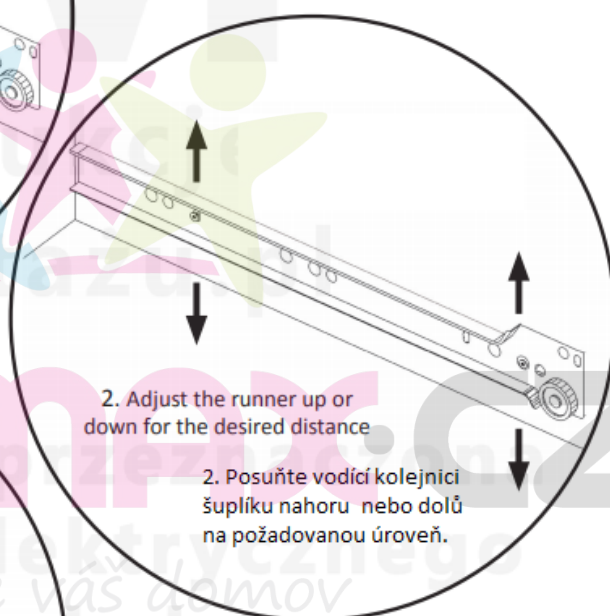

2. Adjust the runner up or down for the desired distance

2. Posuňte vodící kolejnici šuplíku nahoru nebo dolů na požadovanou úroveň.

3. Utáhněte dříve uvolněné šrouby.

4. Zasuňte zásuvku a zkontrolujte její polohu.

5. Pokud je zásuvka správně umístěna, zašroubujte další tři šrouby pro stabilizaci.

**V případě potřeby opakujte jednotlivé kroky.
If necessary, repeat the steps.**