



















Dětský úložný regál ANIMALS TYP1 RN01

NÁVOD K MONTÁŽI

Příslušenství / Fittings						
K1  12 ks / pcs	M2  16 ks / pcs	M1  16 ks / pcs	ZM1  16 ks / pcs	ZW1  12 ks / pcs	T2  8 ks / pcs	G1  12 ks / pcs
W1  Ø3 x 16 24 ks / pcs	B1  4 ks / pcs	W4  Ø4 x 16 16 ks / pcs	W6  Ø6,3 x 50 12 ks / pcs	U1  2 ks / pcs	U2  4 ks / pcs	N1  4 ks / pcs
P1-A  300mm 2 ks / pcs	P1-B  300mm 2 ks / pcs	P2-A  300mm 2 ks / pcs	P2-B  300mm 2 ks / pcs			

Nástroje / Tools		
		

MONTÁŽ REGÁLU JE MOŽNÁ POUZE VE DVOU OSOBÁCH

**VELMI DŮLEŽITÉ!
ČTĚTE PEČLIVĚ
NÁVOD SI ULOŽTE PRO POZDĚJŠÍ POUŽITÍ
UŽIVATELSKÁ PŘÍRUČKA**

1.
Veškerý obalový materiál odstraňte mimo dosah dětí, tak aby nemohlo dojít k udušení nebo uškrcení.
2.
Všechny spoje musí být řádně dotaženy, žádná součástka nesmí zůstat volná.
3.
Nábytek nepoužívejte v případě, že je nějaká součástka poškozená, či chybí.
4.
Používejte pouze součástky dodané výrobcem.
5.
Nepokládejte nábytek do blízkosti otevřeného ohně nebo k jiným zdrojům tepla, jako je elektrické nebo plynové topení apod., mohlo by dojít ke vznícení.
6.
Nábytek musí být připevněn ke stěně pomocí dodané pásky jako ochrana před převrácením.

**VERY IMPORTANT!
PLEASE READ CAREFULLY
SAVE FOR FUTURE USE
USER'S MANUAL**

1.
To avoid the danger of choking or strangulation keep the package with fittings away from babies and children.
2.
All connections must be tightened properly and no coupled element can not be loose.
3.
Do not use the bed when, if any of the elements is damaged or if there is any element missing.
4.
Use only the elements given by manufacturer.
5.
Do not place the bed near naked flames or other heat sources such as electric or gas radiators etc., this may cause a fire.
6.
Do not leave anything in the bed and do not place the crib near any equipment, where a child can prop up its foot or cause danger of strangulation or hanging of a child, e.g. wires, strings of drapers/curtains.

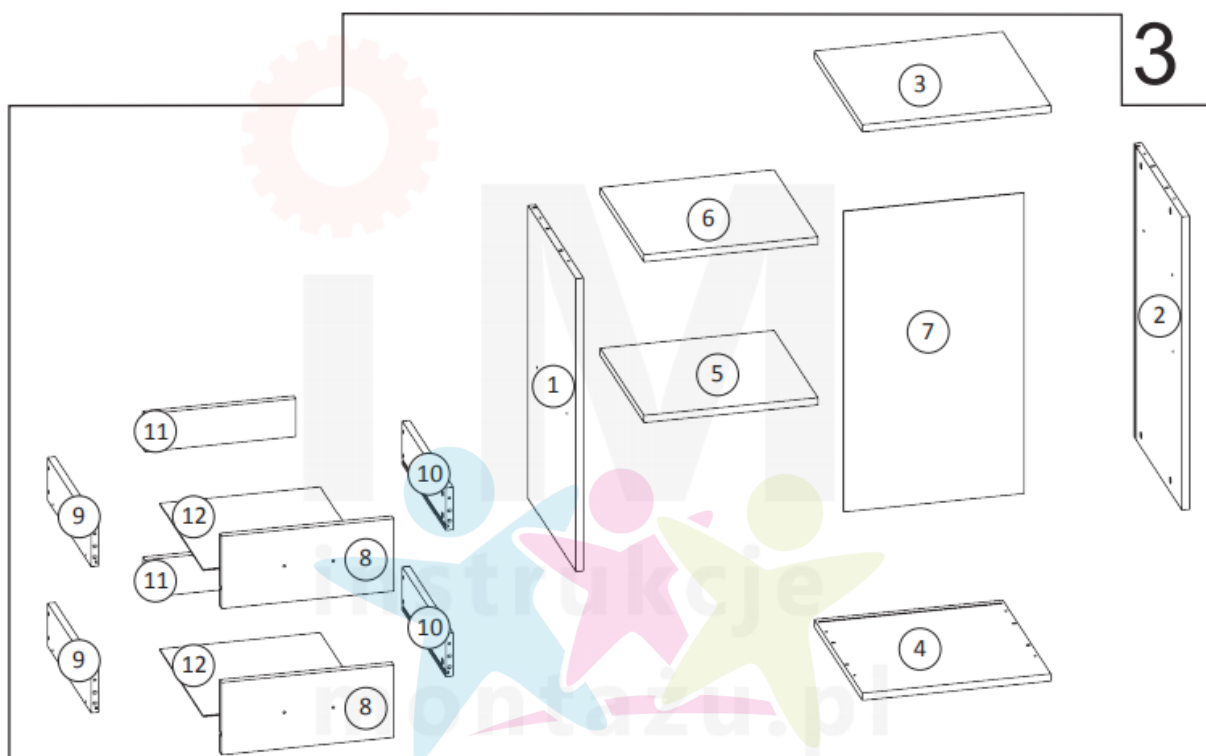

Balení 1 z 1 / Package 1 of 1

Číslo položky / item no.	Rozměry (mm) / Dimensions (mm)	Počet / Quantity
1	760 x 340 x 18	1
2	760 x 340 x 18	1
3	452 x 342 x 18	1
4	452 x 342 x 18	1
5	414 x 307 x 18	1
6	414 x 297 x 18	1
7	778 x 431 x 3	1
8	410 x 188 x 18	2
9	300 x 138 x 18	2
10	300 x 138 x 18	2
11	353 x 120 x 18	2
12	371 x 304 x 18	2

Před montáží se ujistěte, že balení obsahuje všechny položky uvedené na této stránce a zkontrolujte, jestli žádná z položek není poškozena. V případě, že některá z položek chybí nebo jeví známky poškození, kontaktujte prodejce tohoto výrobku.

BEFORE ASSEMBLING THE FURNITURE PLEASE CHECK THAT PACKAGES INCLUDE ALL ITEMS LISTED IN THE TABLE ON PAGE NO 3, AND WHETHER THESE ITEMS ARE NOT DAMAGED !!!
IF MISSING PARTS OR SOME OF THEM ARE DAMAGED, PLEASE CONTACT OUR CUSTOMER SERVICE OFFICE.
DAMAGES FOUND AFTER ASSEMBLING WILL NOT BE CONSIDERED !!!

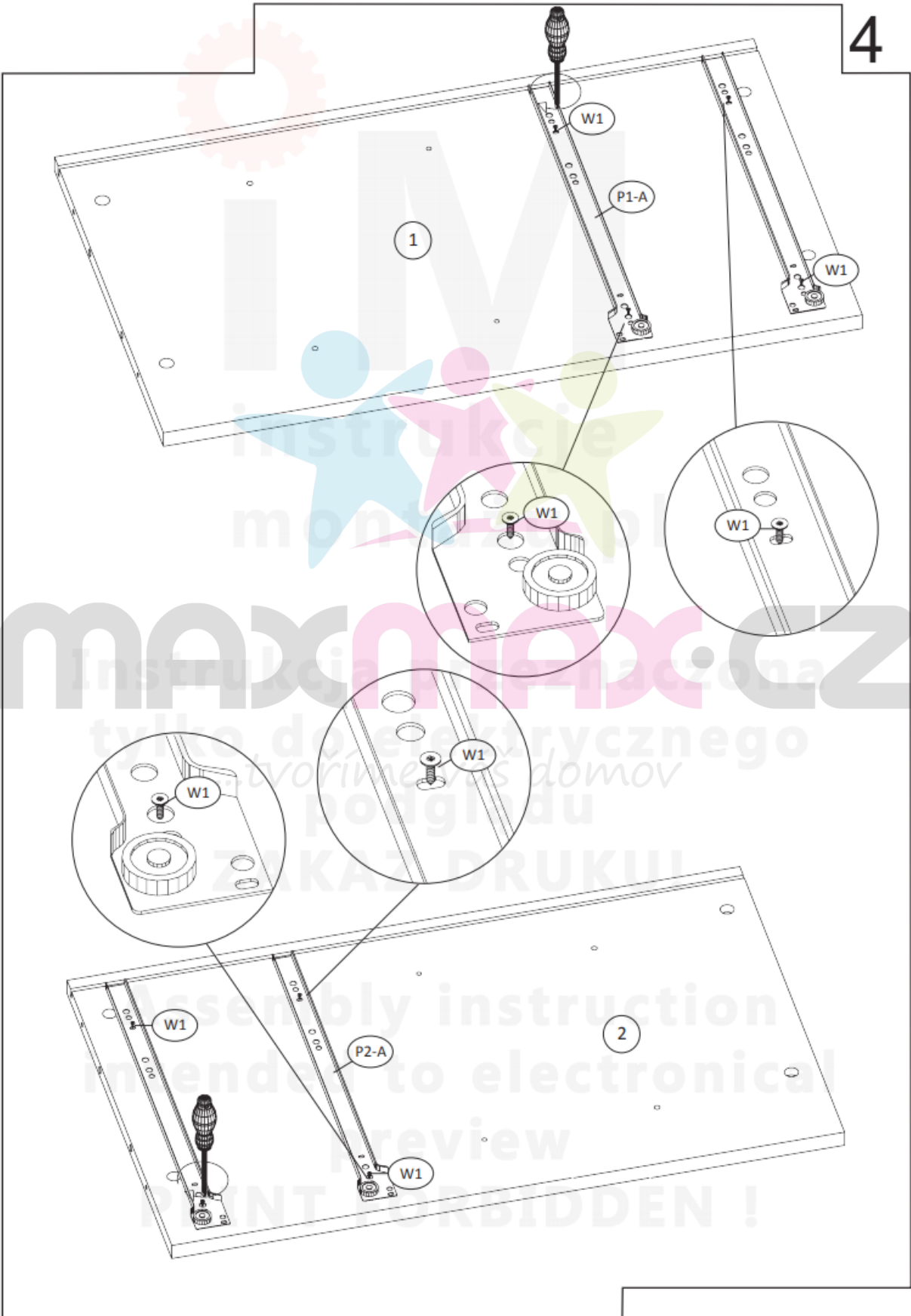

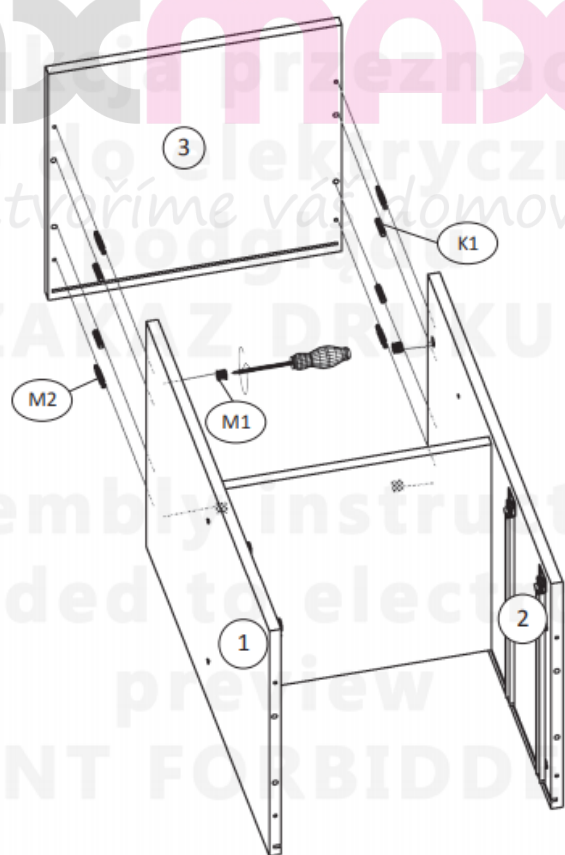
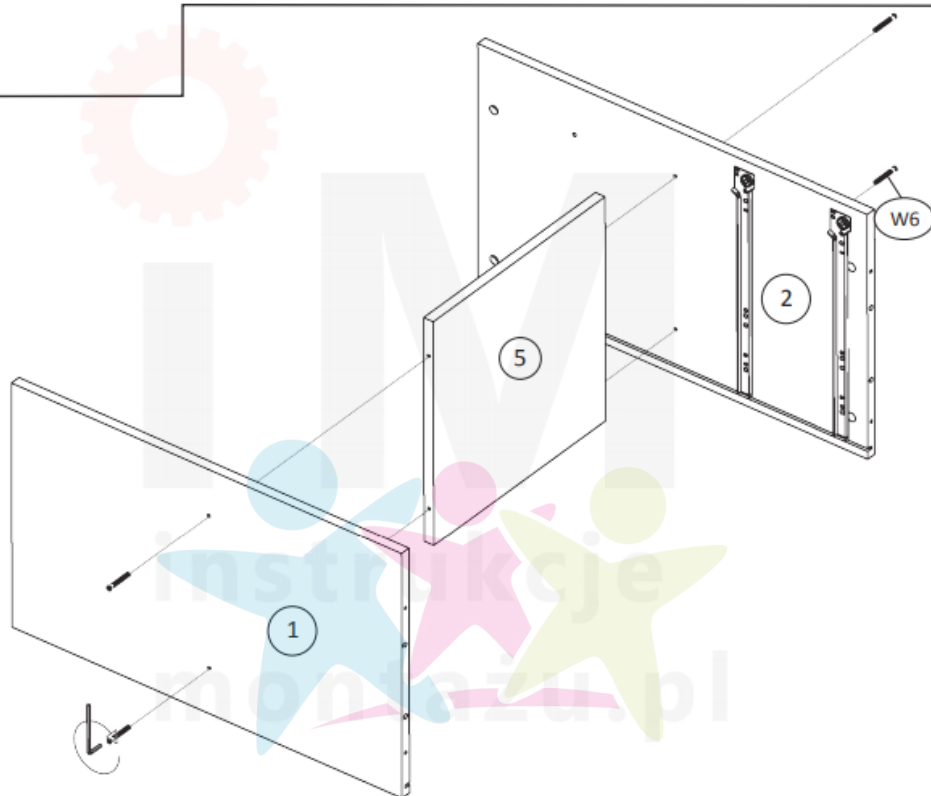

maxmax.cz
Instrukcja przeznaczona
tylko do elektrycznego
...tróime váš domov
ZAKAZ DRIKU!
Assembly instruction
intended to electrical
pre view
PRINT FORBIDDEN!

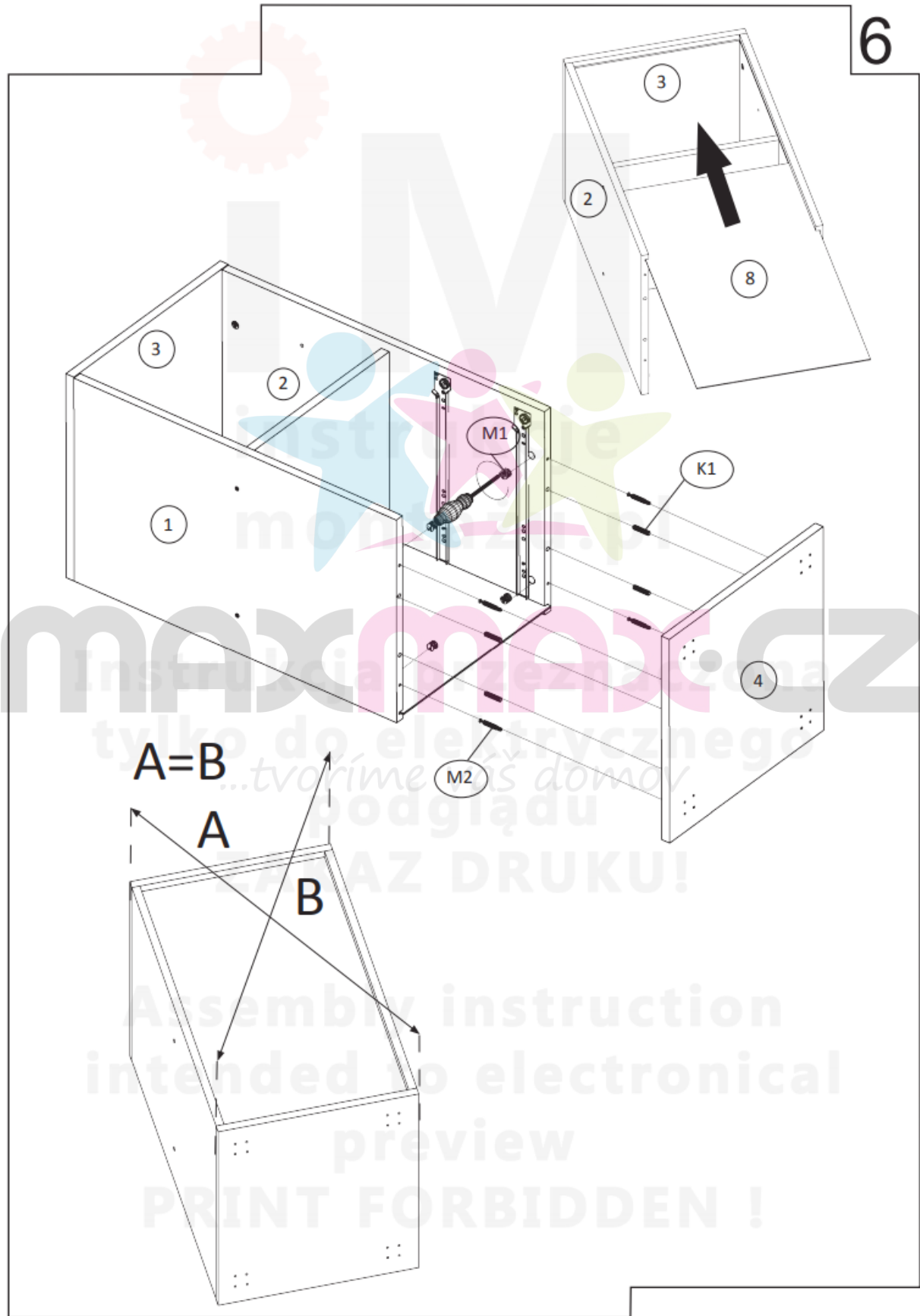

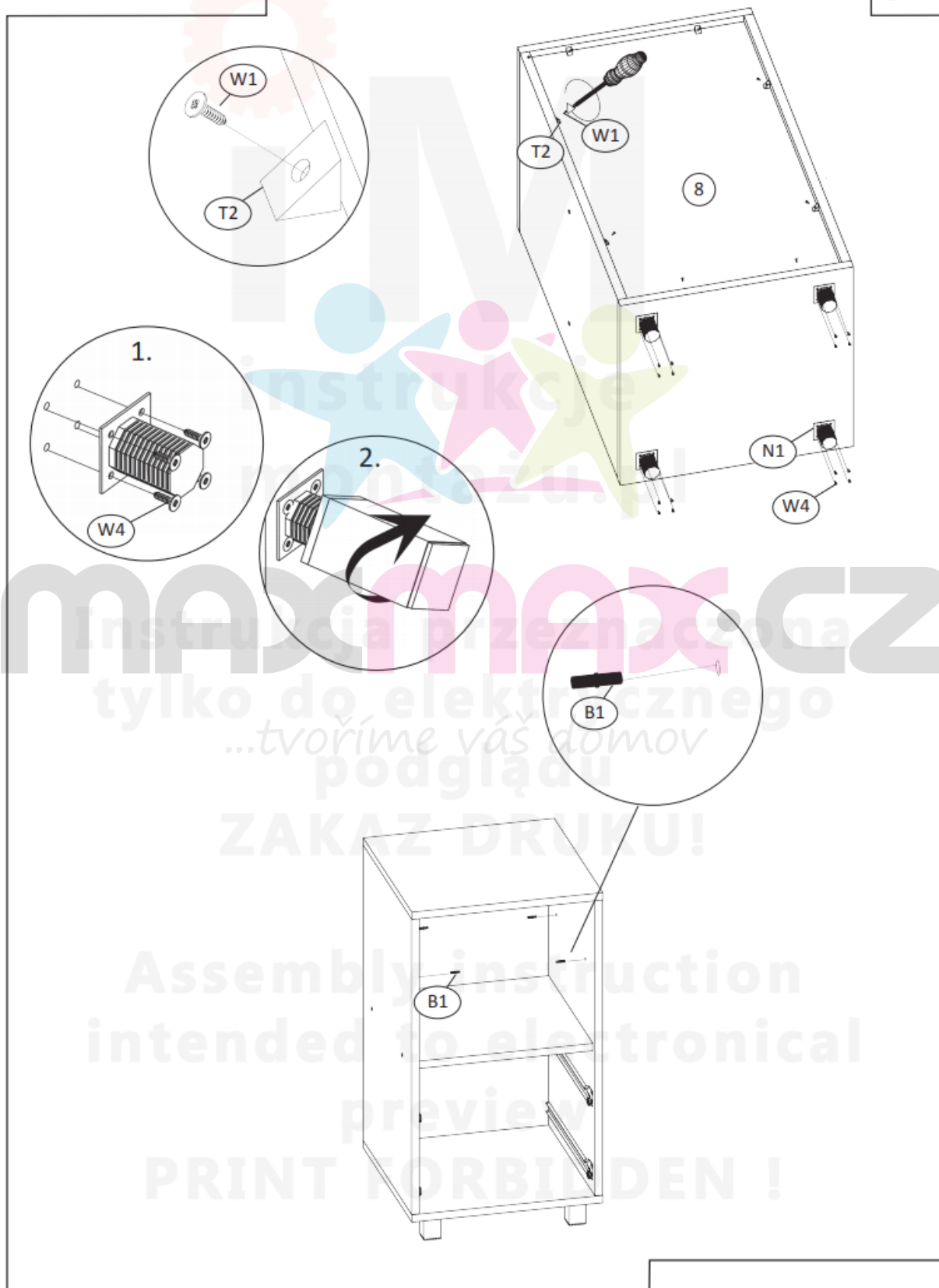

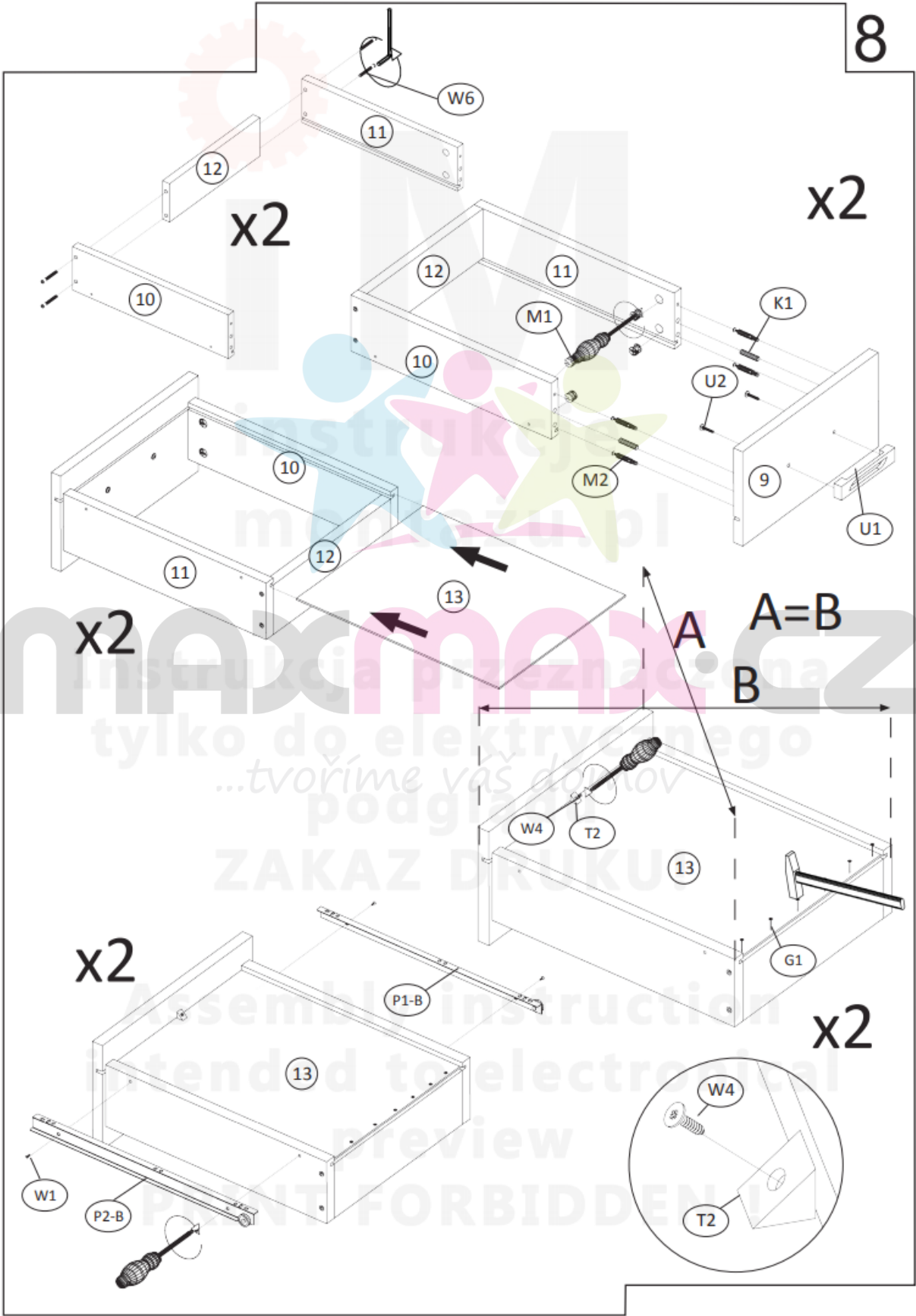

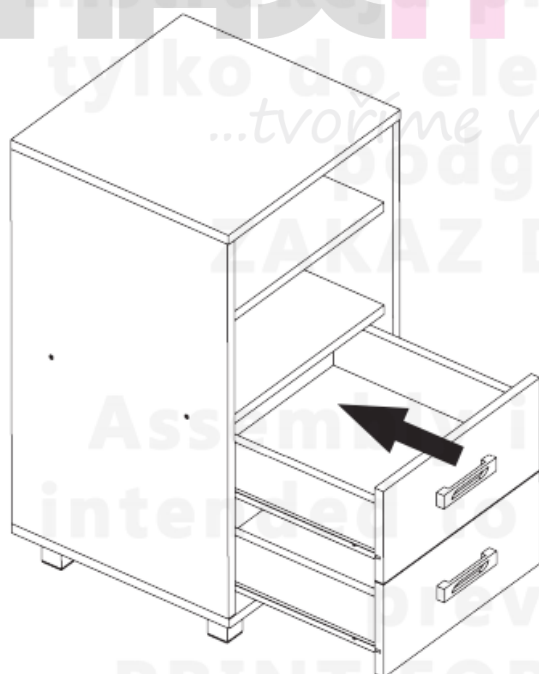
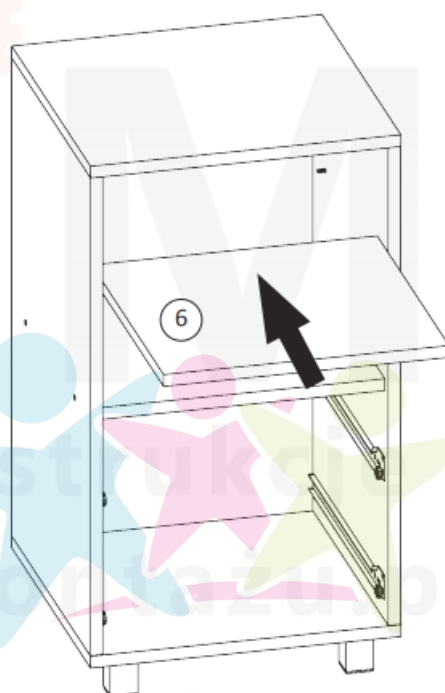

Na viditelné šrouby (W6) je potřeba umístit dodávané krytky (ZW1).

On the visible screws (W6) should be placed supplied adhesive caps (ZW1).

Na excentry (M1) je potřeba umístit dodávané krytky (ZM1).

On the eccentrics (M1) should be placed supplied plastic caps (ZM1).

PRINT FORBIDDEN !

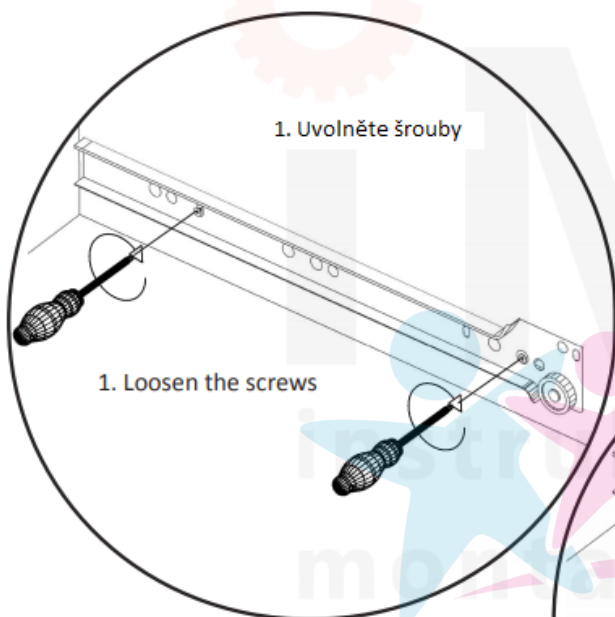

1. Uvolněte šrouby

1. Loosen the screws

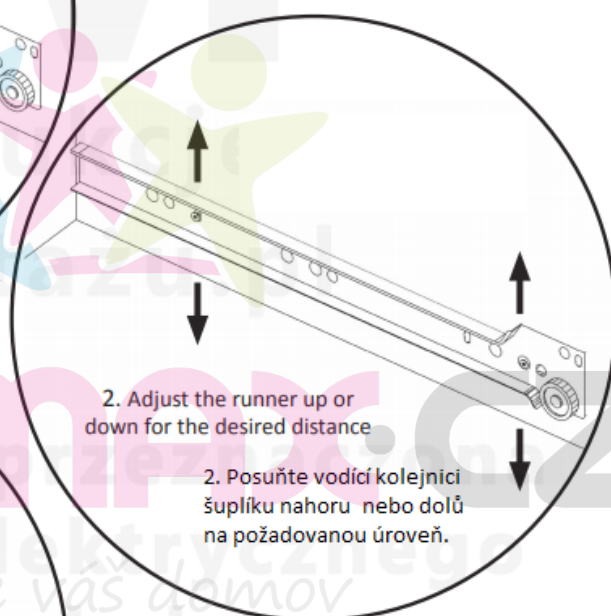

2. Adjust the runner up or down for the desired distance

2. Posuňte vodící kolejnici šuplíku nahoru nebo dolů na požadovanou úroveň.

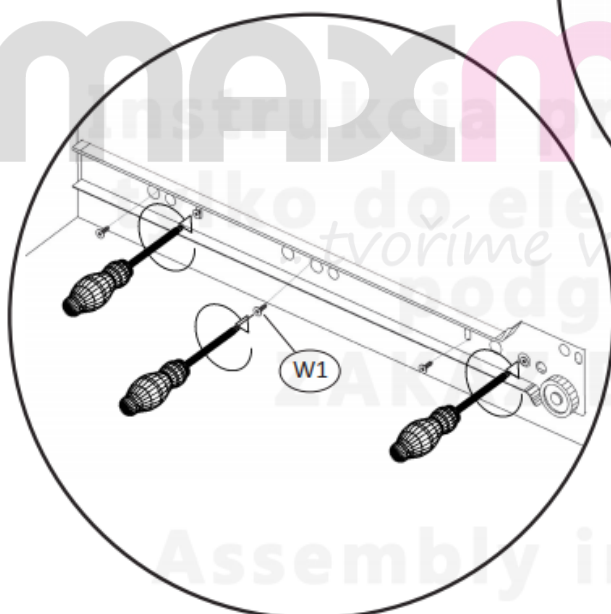

3. Tighten the screws loosened earlier.

4. Slide the drawer and check their positions.

5. If the drawers are mounted properly tighten another 3 screws to stabilize each drawer runner.

3. Utáhněte dříve uvolněné šrouby.

4. Zasuňte zásuvku a zkontrolujte její polohu.

5. Pokud je zásuvka správně umístěna, zašroubujte další tři šrouby pro stabilizaci.

**V případě potřeby opakujte jednotlivé kroky.
If necessary, repeat the steps.**

Assembly instruction

intended to electrical

prevent

PRINT FORBIDDEN !