





















**Dětský úložný regál ANIMALS TYP 10  
NÍZKÝ  
RN10**

**NÁVOD K MONTÁŽI**

**Příslušenství / Fittings**

K1  14 ks / pcs	M2  18 ks / pcs	M1  18 ks / pcs	ZM1  18 ks / pcs	ZW1  14 ks / pcs	T2  16 ks / pcs	G1  25 ks / pcs
W1  Ø3 x 16 24 ks / pcs	B1  8 ks / pcs	W4  Ø4 x 16 16 ks / pcs	W6  Ø6.3 x 50 14 ks / pcs	U1  4 ks / pcs	U2  8 ks / pcs	N1  4 ks / pcs
P1-A  300mm 2 ks / pcs	P1-B  300mm 2 ks / pcs	P2-A  300mm 2 ks / pcs	P2-B  300mm 2 ks / pcs	T1  4 ks / pcs		

**Nástroje / Tools**



**MONTÁŽ REGÁLU JE MOŽNÁ POUZE VE DVOU OSOBÁCH**

**VELMI DŮLEŽITÉ!  
ČTĚTE PEČLIVĚ  
NÁVOD SI ULOŽTE PRO POZDĚJŠÍ POUŽITÍ  
UŽIVATELSKÁ PŘÍRUČKA**

1.

**Veškerý obalový materiál odstraňte mimo dosah dětí, tak aby nemohlo dojít k udušení nebo uškrcení.**

2.

**Všechny spoje musí být řádně dotaženy, žádná součástka nesmí zůstat volná.**

3.

**Nábytek nepoužívejte v případě, že je nějaká součástka poškozená, či chybí.**

4.

**Používejte pouze součástky dodané výrobcem.**

5.

**Nepokládejte nábytek do blízkosti otevřeného ohně nebo k jiným zdrojům tepla, jako je elektrické nebo plynové topení apod., mohlo by dojít ke vznícení.**

6.

**Nábytek musí být připevněn ke stěně pomocí dodané pásky jako ochrana před převrácením.**

**VERY IMPORTANT!  
PLEASE READ CAREFULLY  
SAVE FOR FUTURE USE**

**USER'S MANUAL**

1.

To avoid the danger of choking or strangulation keep the package with fittings away from babies and children.

2.

All connections must be tightened properly and no coupled element can not be loose.

3.

Do not use the bed when, if any of the elements is damaged or if there is any element missing.

4.

Use only the elements given by manufacturer.

5.

Do not place the bed near naked flames or other heat sources such as electric or gas radiators etc., this may cause a fire.

6.

Do not leave anything in the bed and do not place the crib near any equipment, where a child can prop up its foot or cause danger of strangulation or hanging of a child, e.g. wires, strings of drapers/curtains.

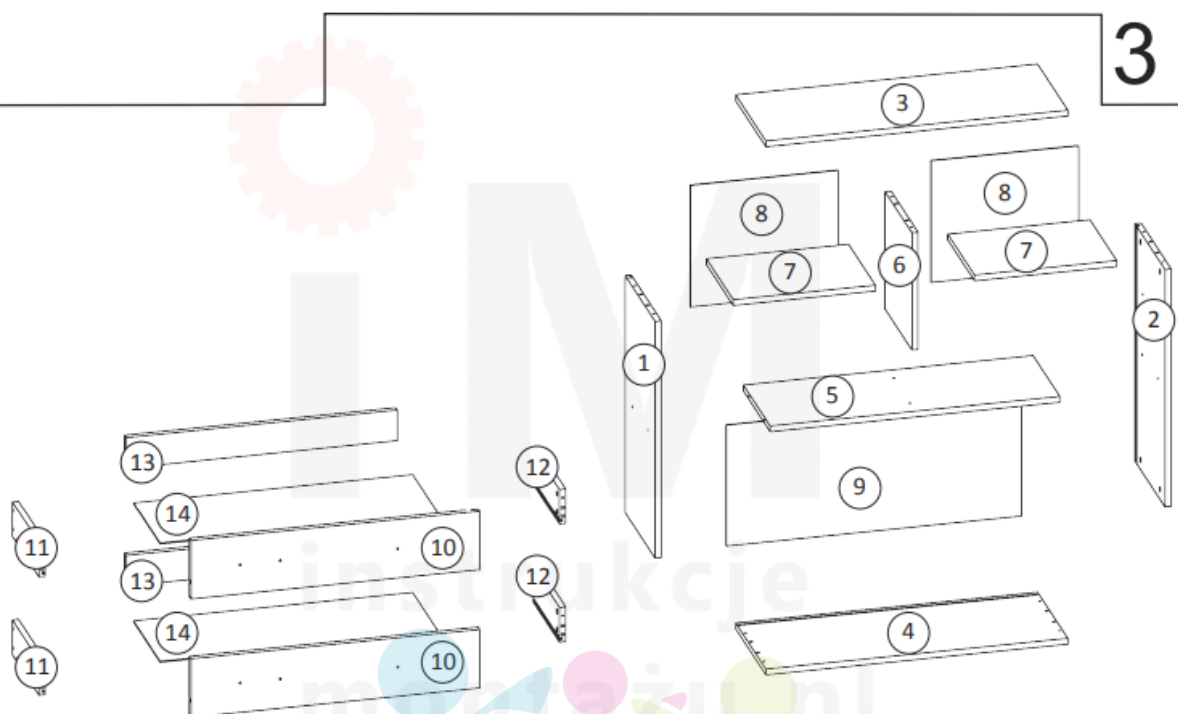
**Balení 1 z 1 / Package 1 of 1**

Číslo položky / item no.	Rozměry (mm) / Dimensions (mm)	Počet / Quantity
1	760 x 340 x 18	1
2	760 x 340 x 18	1
3	884 x 342 x 18	1
4	884 x 342 x 18	1
5	846 x 307 x 18	1
6	846 x 307 x 18	1
7	414 x 297 x 18	2
8	386 x 431 x 3	2
9	392 x 864 x 3	1
10	842 x 188 x 18	2
11	300 x 138 x 18	2
12	300 x 138 x 18	2
13	785 x 120 x 18	2
14	803 x 304 x 3	2

PRZED MONTAŻEM MEBLA NALEŻY DOKŁADNIE SPRAWDZIĆ CZY PACZKI ZAWIERAJĄ WSZYSTKIE ELEMENTY WYSZCZEGÓLNIONE W TABELCE NA STRONIE 3 ORAZ CZY ELEMENTY TE NIE SĄ USZKODZONE !!!  
JEŚLI BRAKUJE ELEMENTÓW LUB NIEKTÓRE Z NICH SĄ USZKODZONE PROSIMY O KONTAKT Z NASZYM BIUREM OBSŁUGI KLIENTA.

USZKODZENIA ELEMENTÓW STWIERDZONE JUŻ PO MONTAŻU MEBLA NIE BĘDĄ UWZGLĘDNIANE !!!

BEFORE ASSEMBLING THE FURNITURE PLEASE CHECK THAT PACKAGES INCLUDE ALL ITEMS LISTED IN THE TABLE ON PAGE NO 3, AND WHETHER THESE ITEMS ARE NOT DAMAGED !!!

IF MISSING PARTS OR SOME OF THEM ARE DAMAGED, PLEASE CONTACT OUR CUSTOMER SERVICE OFFICE.  
DAMAGES FOUND AFTER ASSEMBLING WILL NOT BE CONSIDERED !!!

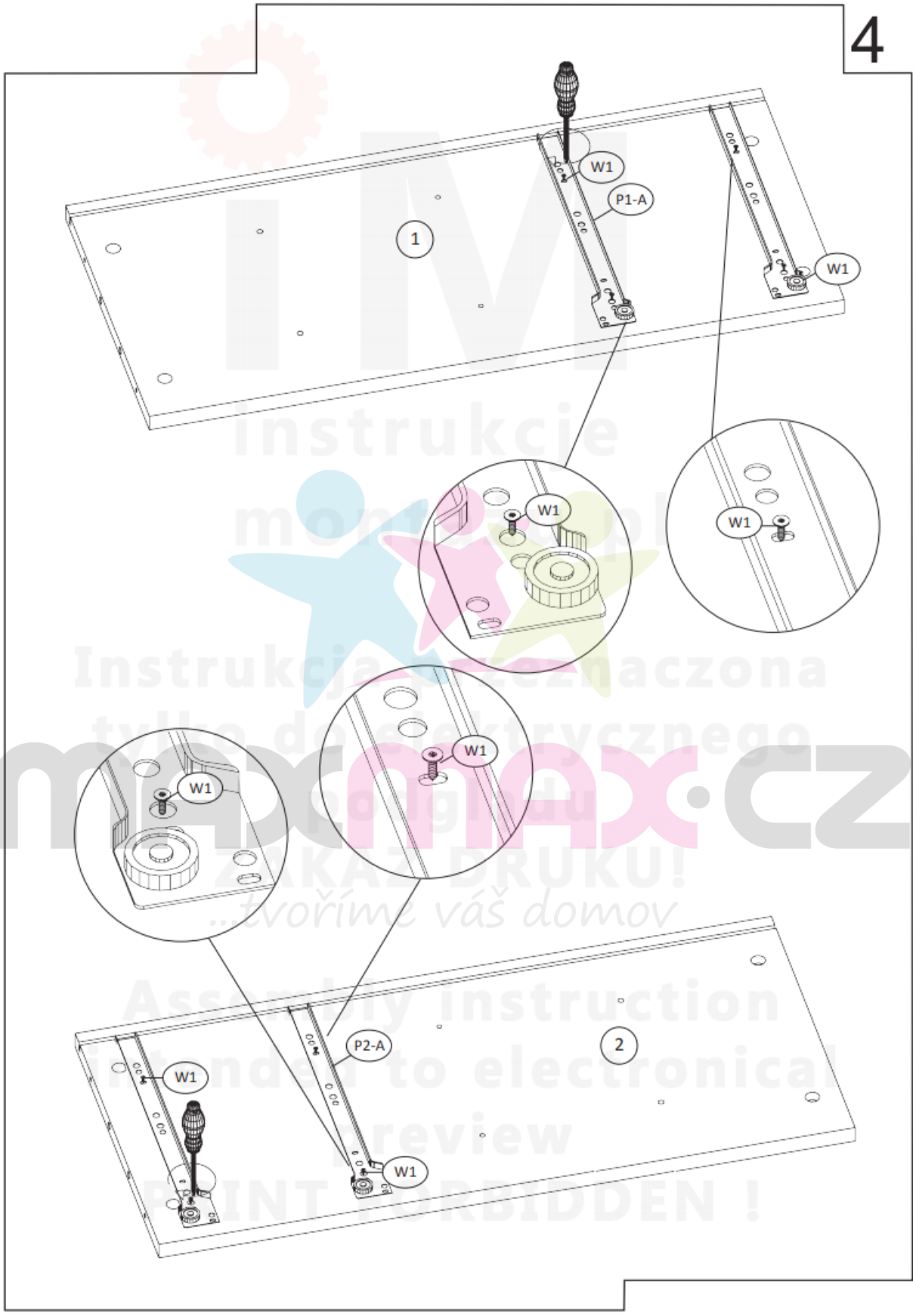

5

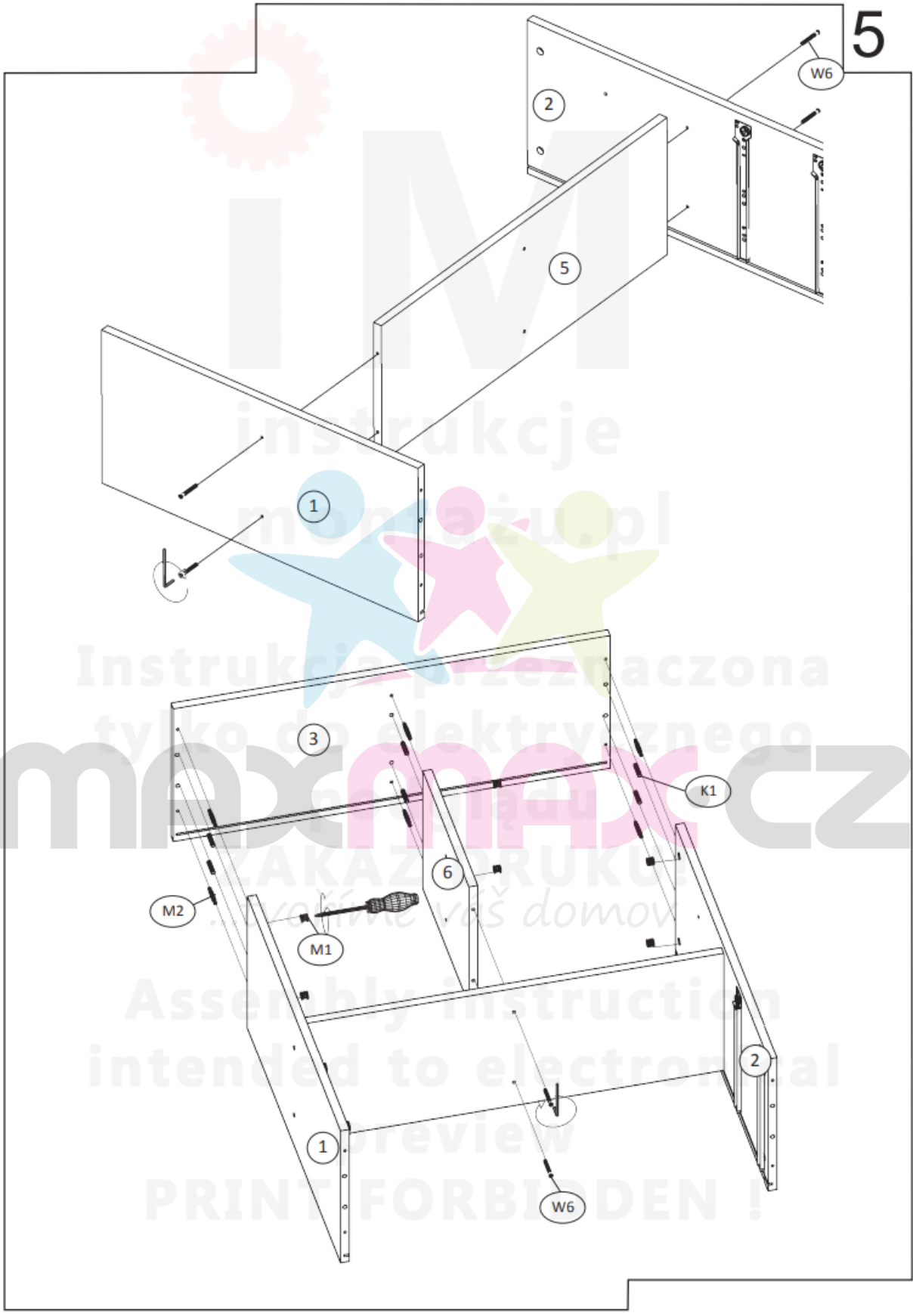

PRINT FORBIDDEN!

6

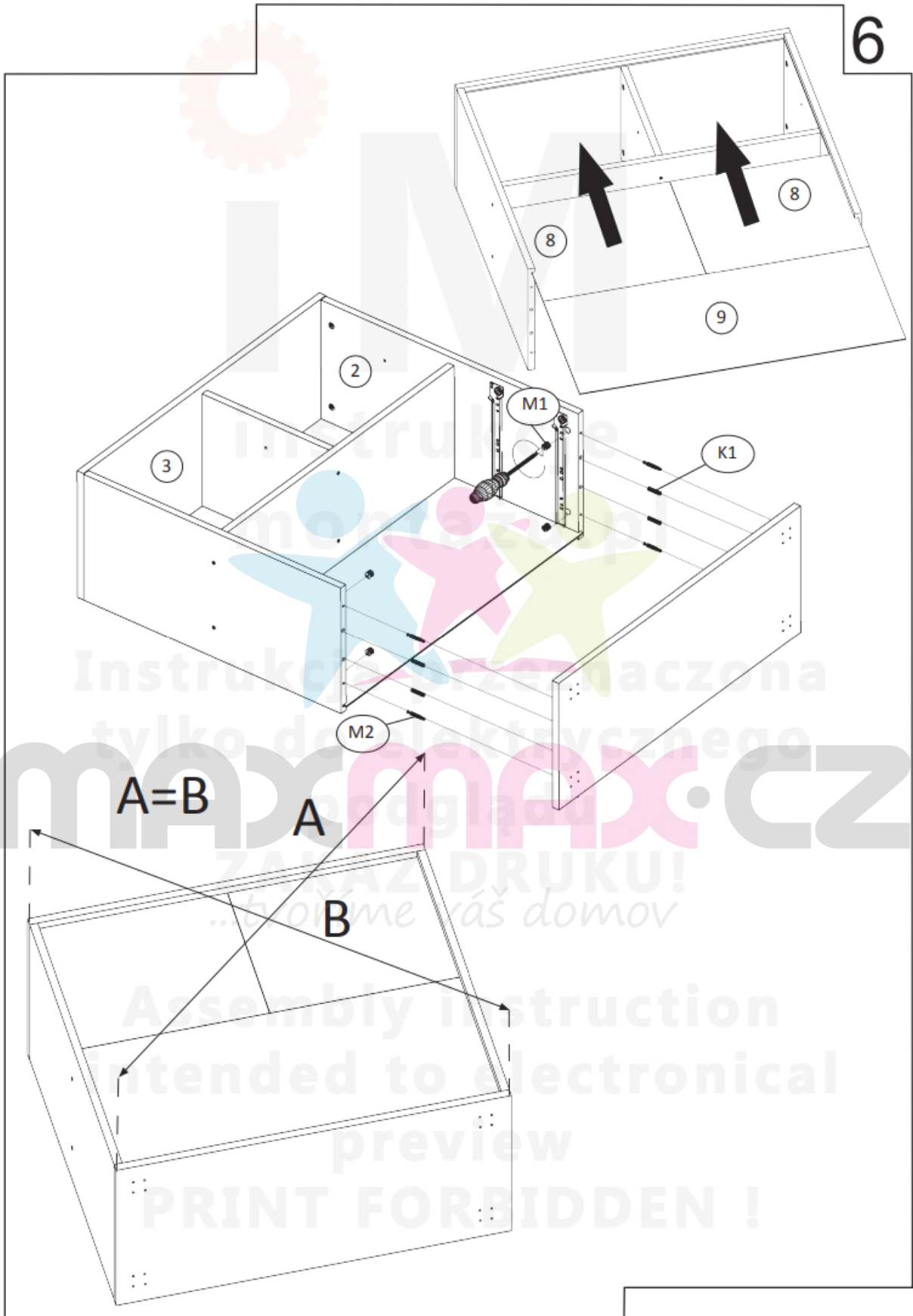

Instrukcja przeznaczona tylko do użytku elektronicznego

maxmax.cz

ZAKAZ DRUKU!  
...tylko w twoim domu

Assembly instruction  
intended to be used electronically  
preview  
PRINT FORBIDDEN!



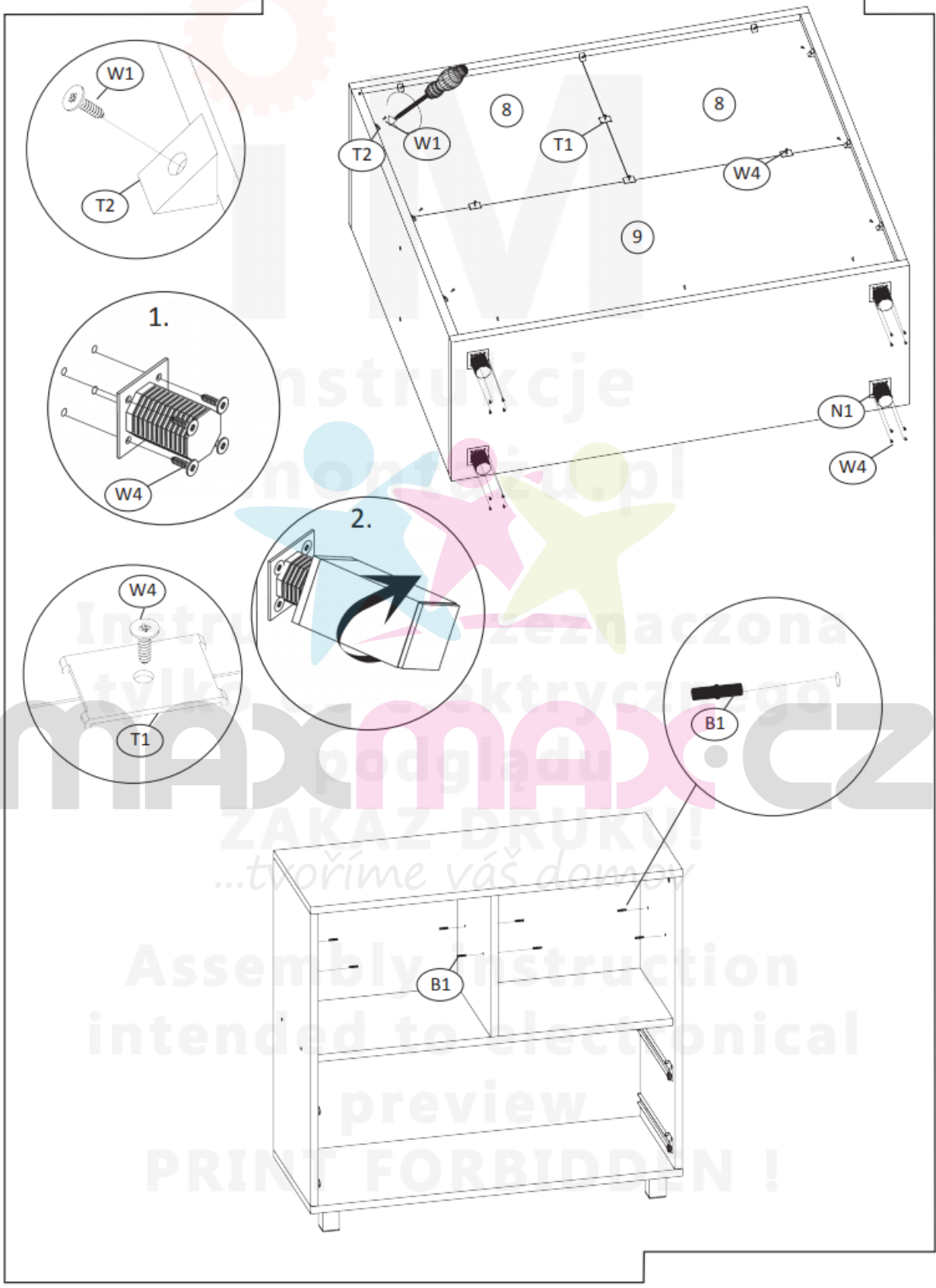

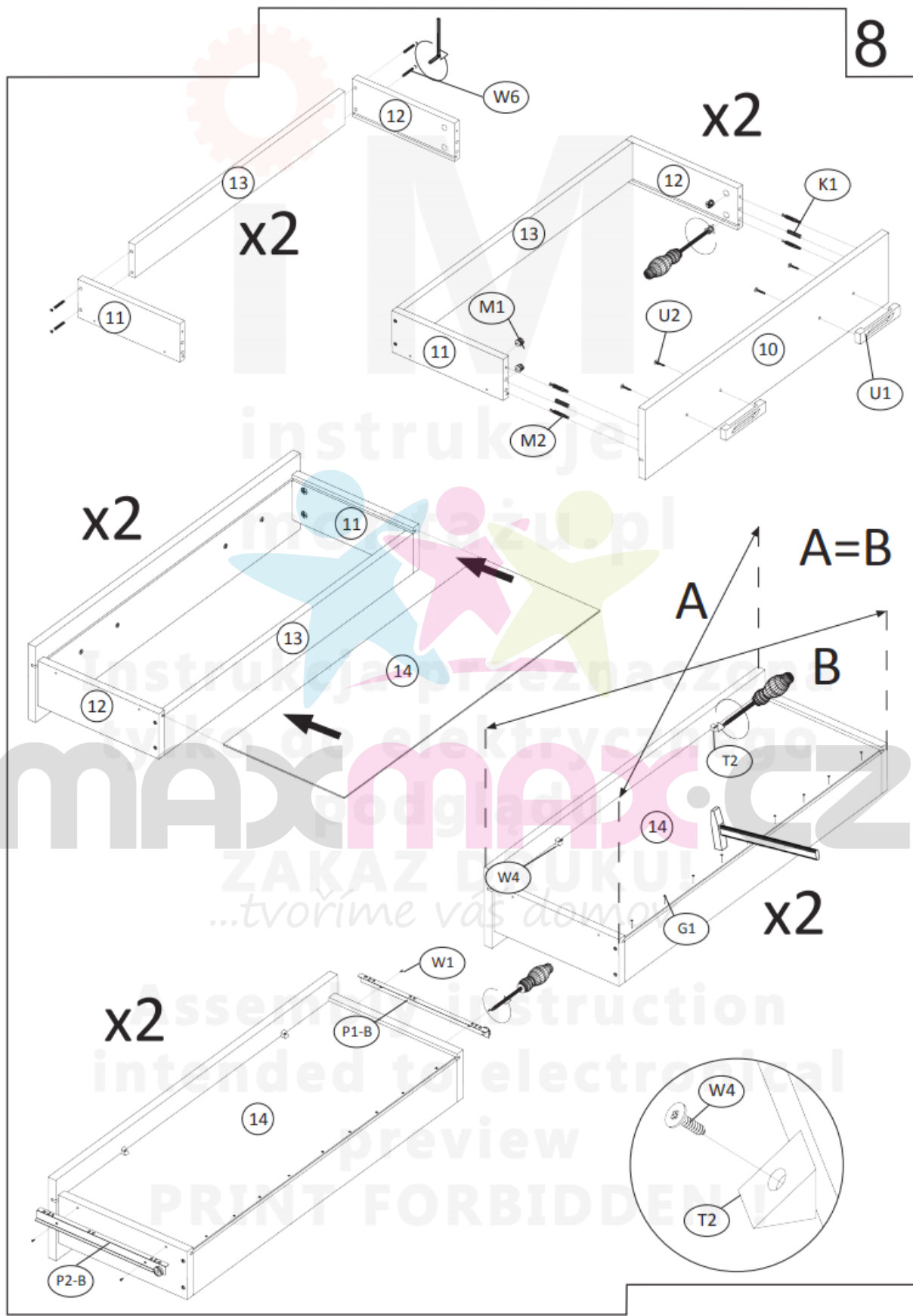



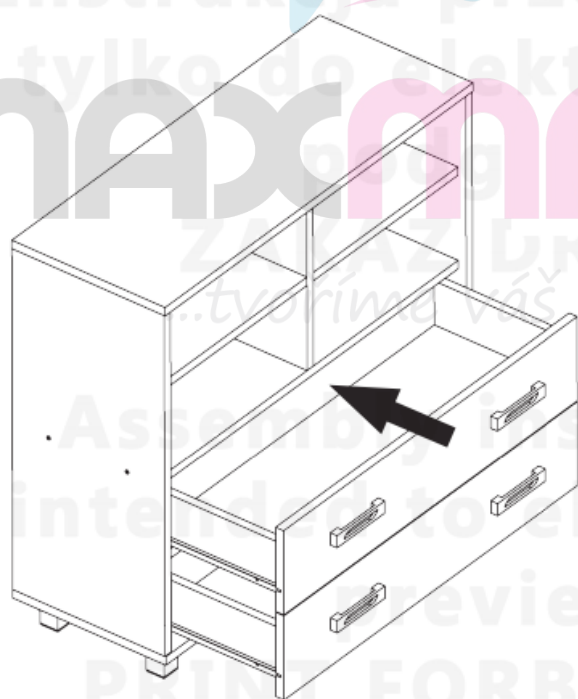
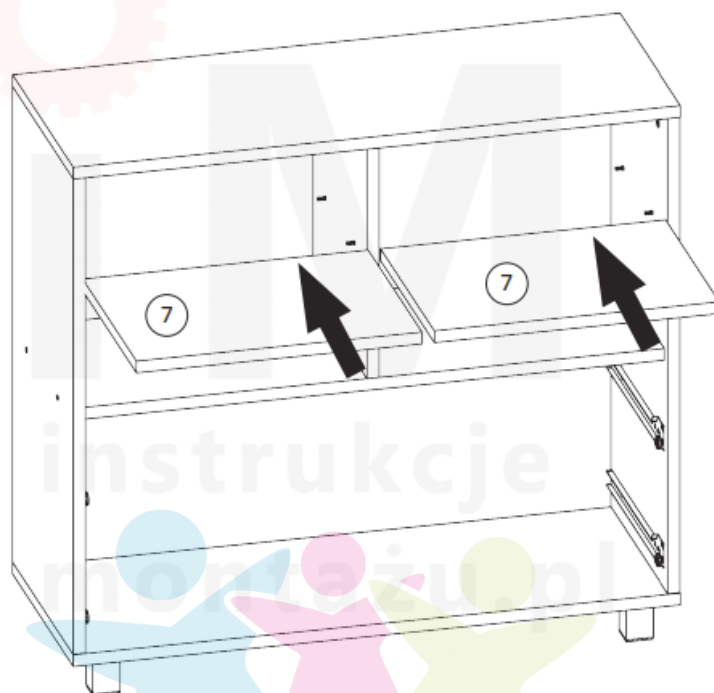

Na viditelné šrouby (W6) je potřeba umístit dodávané krytky (ZW1).

On the visible screws (W6) should be placed supplied adhesive caps (ZW1).

Na excentry (M1) je potřeba umístit dodávané krytky (ZM1).

On the eccentrics (M1) should be placed supplied plastic caps (ZM1).

PRINT FORBIDDEN !

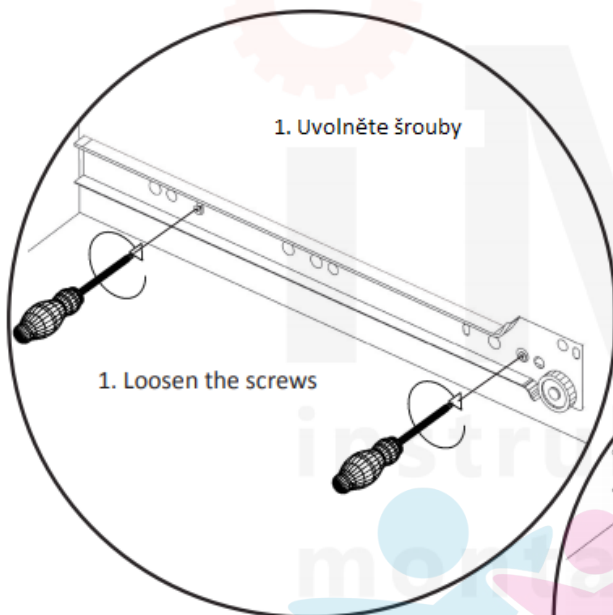

1. Uvolněte šrouby

1. Loosen the screws

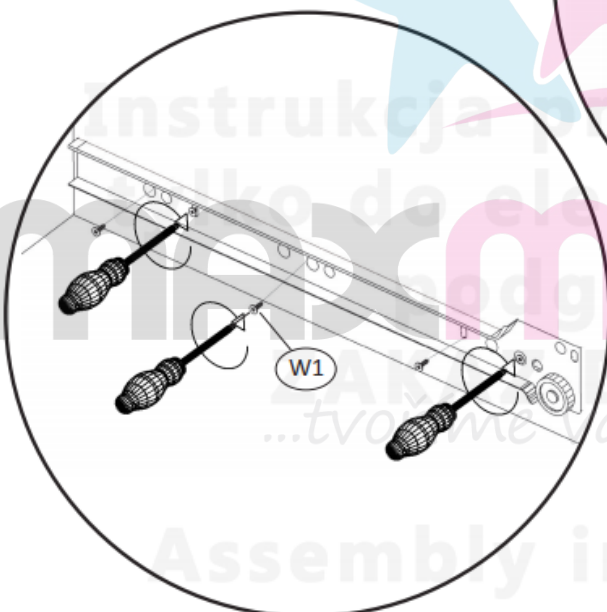

3. Tighten the screws loosened earlier.

4. Slide the drawer and check their positions.

5. If the drawers are mounted properly tighten another 3 screws to stabilize each drawer runner.

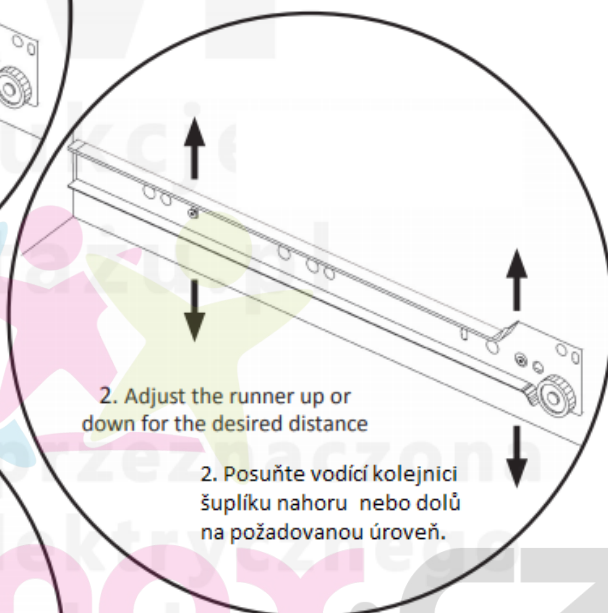

2. Adjust the runner up or down for the desired distance

2. Posuňte vodící kolejnici šuplíku nahoru nebo dolů na požadovanou úroveň.

3. Utáhněte dříve uvolněné šrouby.

4. Zasuňte zásuvku a zkontrolujte její polohu.

5. Pokud je zásuvka správně umístěna, zašroubujte další tři šrouby pro stabilizaci.

**V případě potřeby opakujte jednotlivé kroky.**

**If necessary, repeat the steps.**