

























## Dětská skříň ANIMALS TYP 3B (otevírání doprava)

### NÁVOD K MONTÁŽI

#### Příslušenství/ Fittings

 K1	 M2	 M1	 ZM1	 ZW1	 T2	 G1
14 ks/ pcs	16 ks/ pcs	16 ks/ pcs	16 ks/ pcs	10 ks/ pcs	16 ks/ pcs	10 ks/ pcs
 W1 Ø3 x 16	 B1	 W4 Ø4 x 16	 W6 Ø6,3 x 50	 U1	 U2	 N1
12 ks/ pcs	12 ks/ pcs	28 ks/ pcs	10 ks/ pcs	2 ks/ pcs	4 ks/ pcs	4 ks/ pcs
 P1-A 500 mm	 P1-B 500 mm	 P2-A 500 mm	 P2-B 500 mm	 Z1-A	 Z1-B	
1 ks/ pcs	1 ks/ pcs	1 ks/ pcs	1 ks/ pcs	3 ks/ pcs	3 ks/ pcs	
 W5 Ø4 x 35	 TZ1					
1 ks/ pcs	1 ks/ pcs					

#### Nástroje / Tools



**MONTÁŽ SKŘÍNĚ JE MOŽNÁ POUZE VE DVOU OSOBÁCH**

**VELMI DŮLEŽITÉ!  
ČTĚTE PEČLIVĚ  
NÁVOD SI ULOŽTE PRO POZDĚJŠÍ POUŽITÍ  
UŽIVATELSKÁ PŘÍRUČKA**

1.  
Veškerý obalový materiál odstraňte mimo dosah dětí, tak aby nemohlo dojít k udušení nebo uškrcení.
2.  
Všechny spoje musí být řádně dotaženy, žádná součástka nesmí zůstat volná.
3.  
Nábytek nepoužívejte v případě, že je nějaká součástka poškozená, či chybí.
4.  
Používejte pouze součástky dodané výrobcem.
5.  
Nepokládejte nábytek do blízkosti otevřeného ohně nebo k jiným zdrojům tepla, jako je elektrické nebo plynové topení apod., mohlo by dojít ke vznícení.
6.  
Nábytek musí být připevněn ke stěně pomocí dodané pásky jako ochrana před převrácením.

**VERY IMPORTANT!  
PLEASE READ CAREFULLY  
SAVE FOR FUTURE USE  
USER'S MANUAL**

1.  
To avoid the danger of choking or strangulation keep the package with fittings away from babies and children.
2.  
All connections must be tightened properly and no coupled element can not be loose.
3.  
Do not use the bed when, if any of the elements is damaged or if there is any element missing.
4.  
Use only the elements given by manufacturer.
5.  
Do not place the bed near naked flames or other heat sources such as electric or gas radiators etc., this may cause a fire.
6.  
Do not leave anything in the bed and do not place the crib near any equipment, where a child can prop up its foot or cause danger of strangulation or hanging of a child, e.g. wires, strings of drapers/curtains.

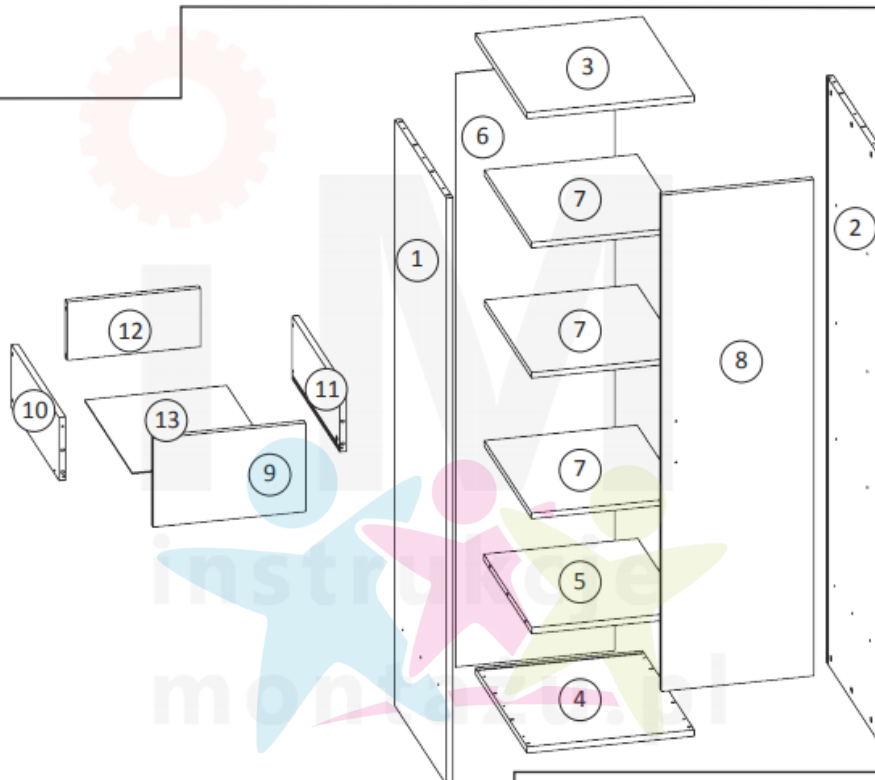
**Balení 1 z 1 / Package 1 of 1**

Číslo položky / item no.	Rozměry (mm) / Dimensions (mm)	Počet / Quantity
1	1672 x 540 x 18	1
2	1672 x 540 x 18	1
3	452 x 542 x 18	1
4	452 x 542 x 18	1
5	414 x 507 x 18	1
6	1690 x 431 x 3	1
7	414 x 497 x 18	3
8	410 x 1416 x 18	1
9	410 x 252 x 18	1
10	500 x 202 x 18	1
11	500 x 202 x 18	1
12	353 x 184 x 18	1
13	371 x 504 x 3	1

Před montáží se ujistěte, že balení obsahuje všechny položky uvedené na této stránce a zkontrolujte, jestli žádná z položek není poškozena. V případě, že některá z položek chybí nebo jeví známky poškození, kontaktujte prodejce tohoto výrobku.

BEFORE ASSEMBLING THE FURNITURE PLEASE CHECK THAT PACKAGES INCLUDE ALL ITEMS LISTED IN THE TABLE ON PAGE NO 3, AND WHETHER THESE ITEMS ARE NOT DAMAGED !!!  
IF MISSING PARTS OR SOME OF THEM ARE DAMAGED, PLEASE CONTACT OUR CUSTOMER SERVICE OFFICE.  
DAMAGES FOUND AFTER ASSEMBLING WILL NOT BE CONSIDERED !!!

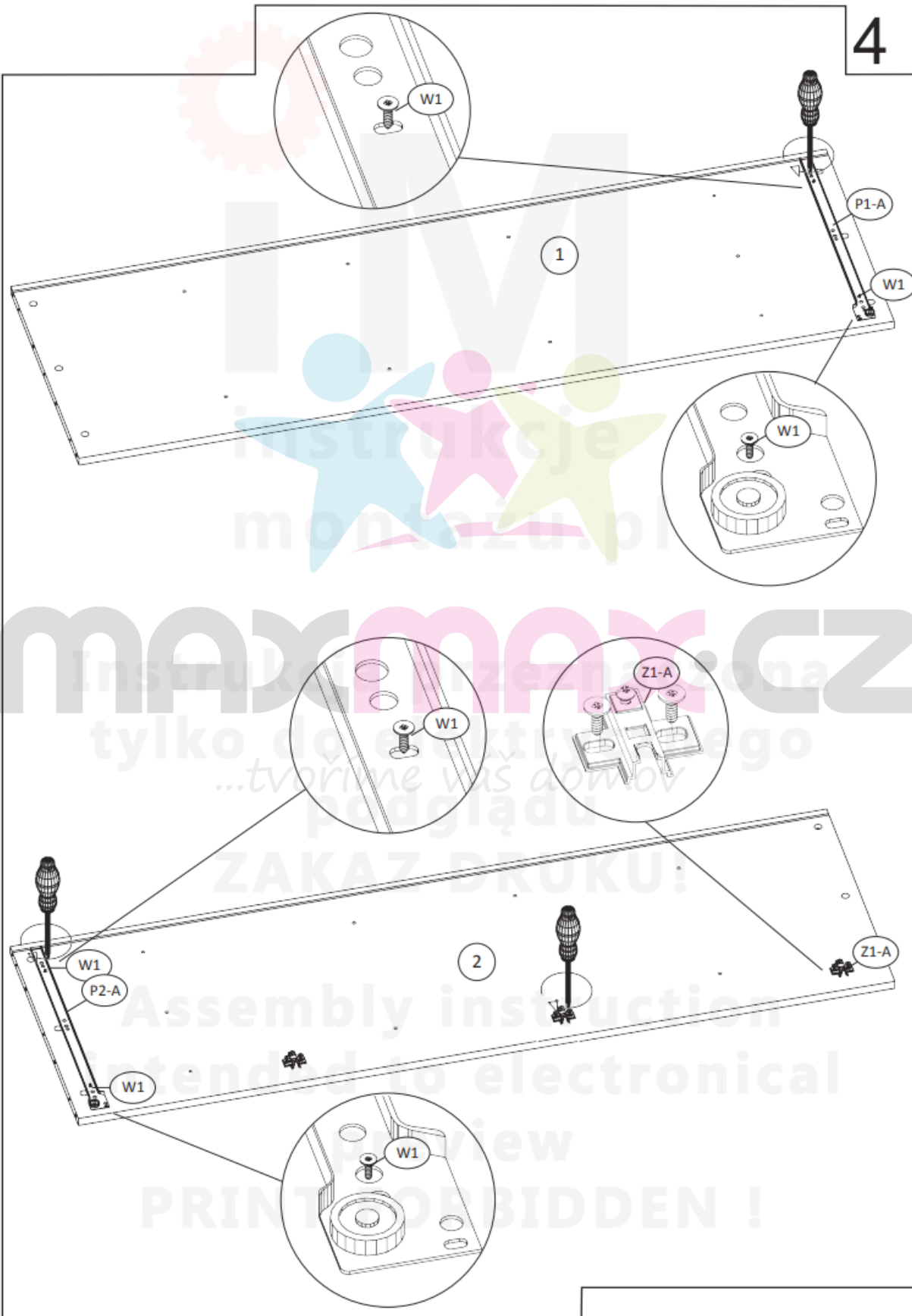

maxmax.cz

Instrukcja obsługi  
tylko do użytku  
...twórcze wasz abnow  
podglądu

ZAKAZ DRUKU!

Assembly instruction  
intended to electrical  
PRINT OR BIDDEN!

5

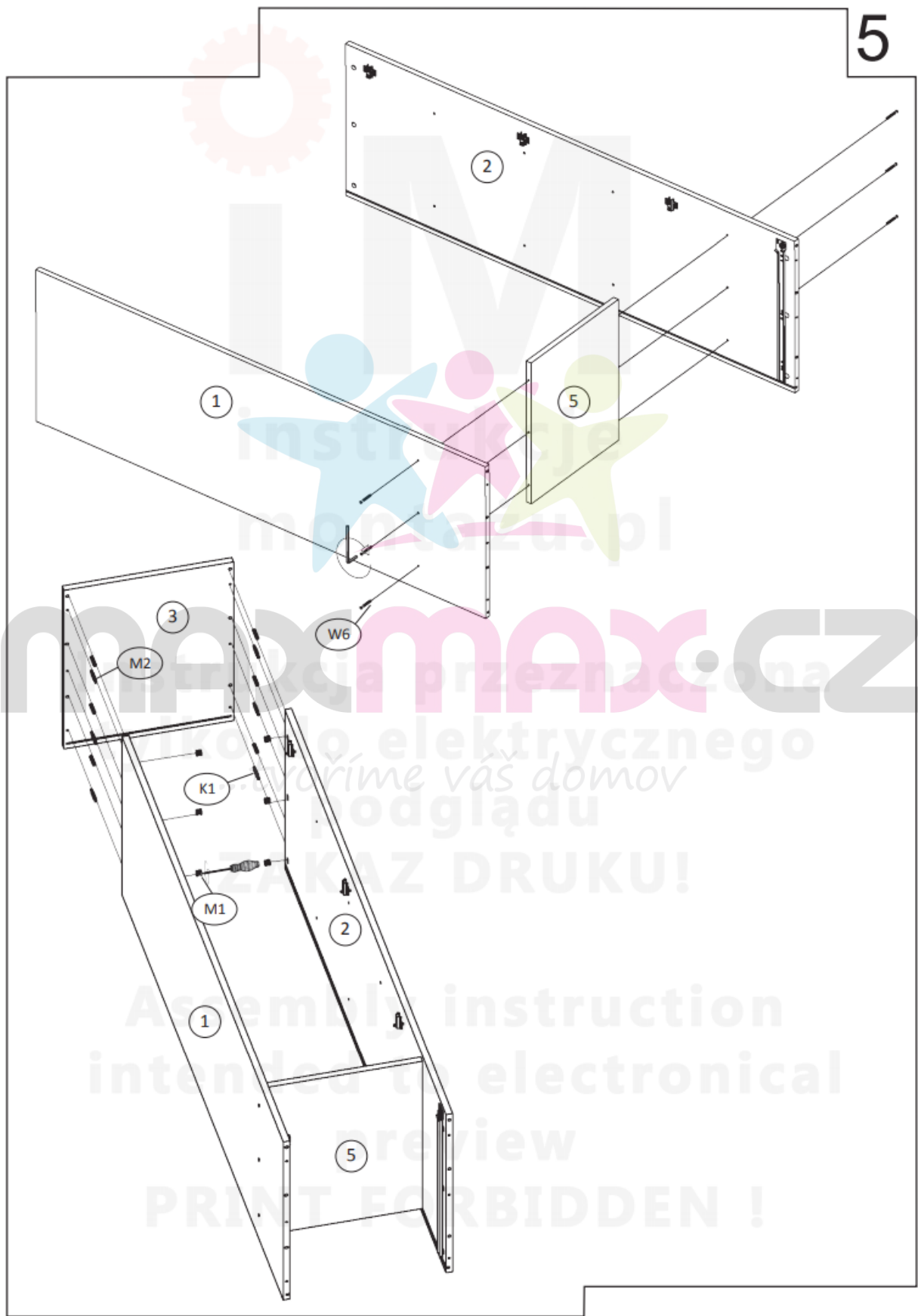

instrukcja przeznaczona do elektrycznego podglądu  
WAKAZ DRUKU!  
Assembly instruction intended to electrical preview  
PRINT FORBIDDEN!

6

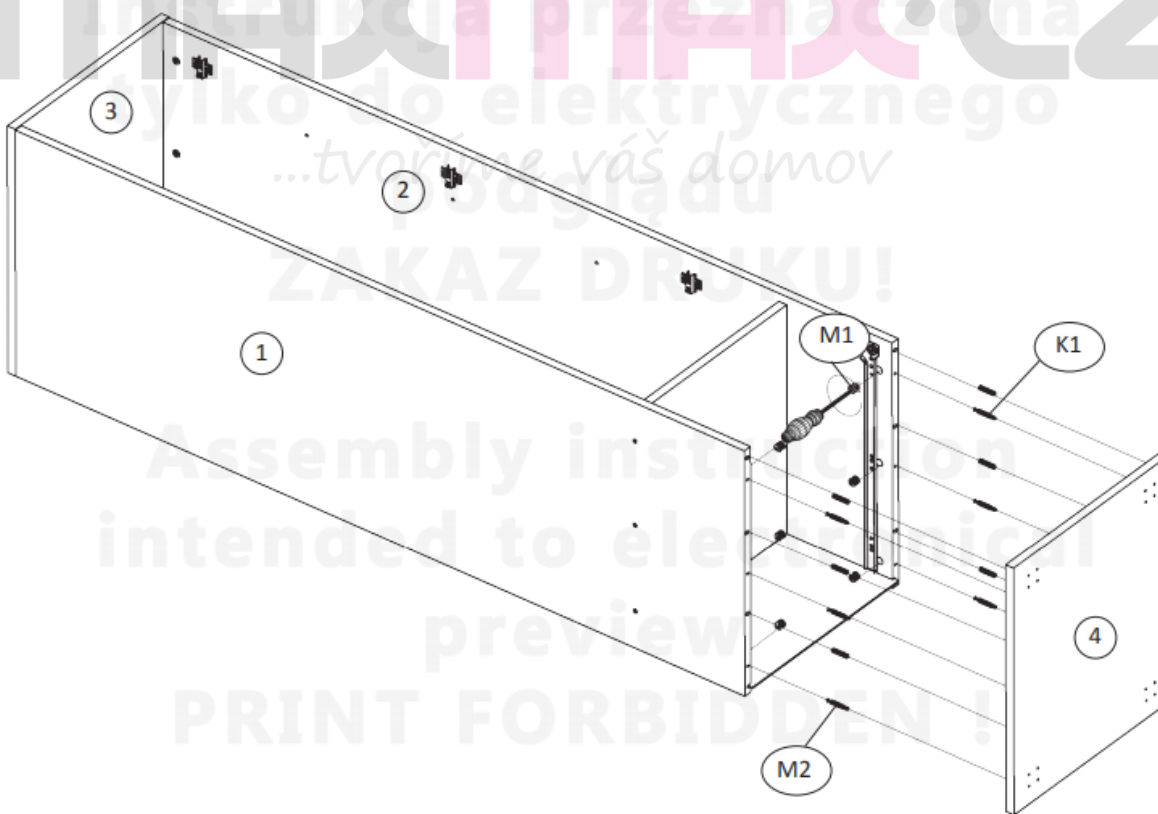
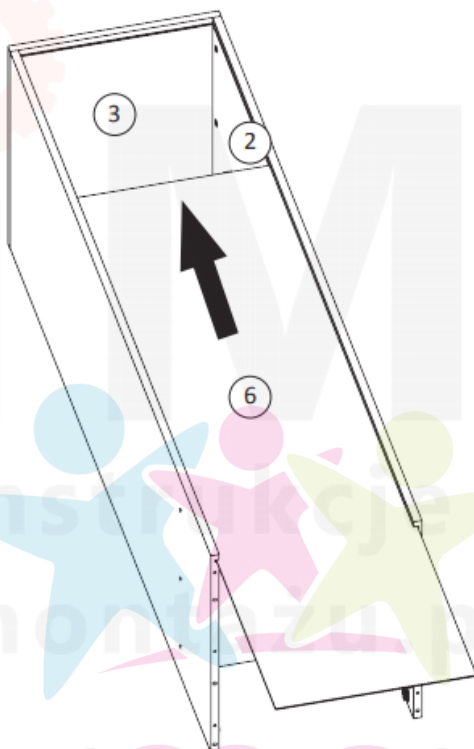



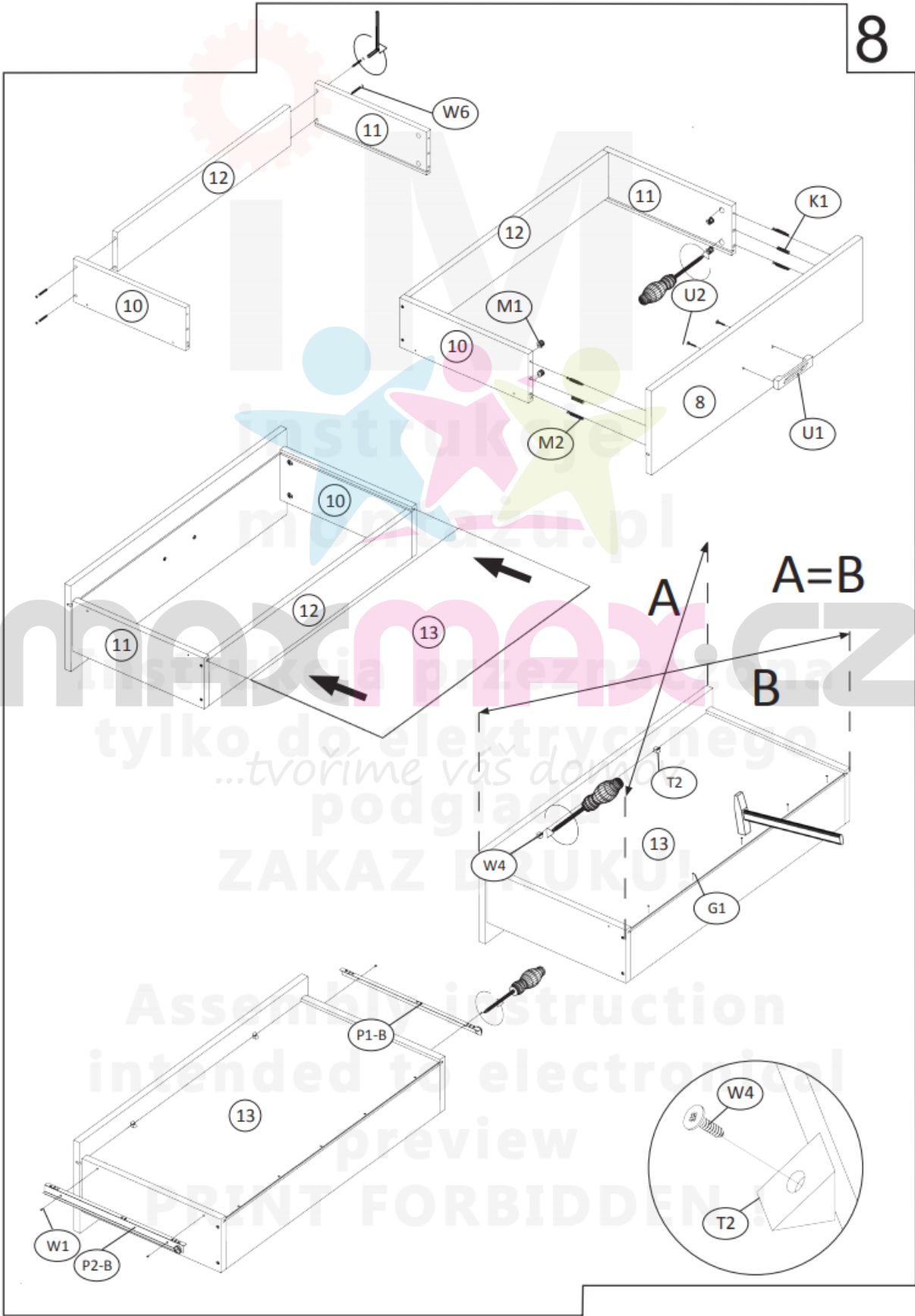



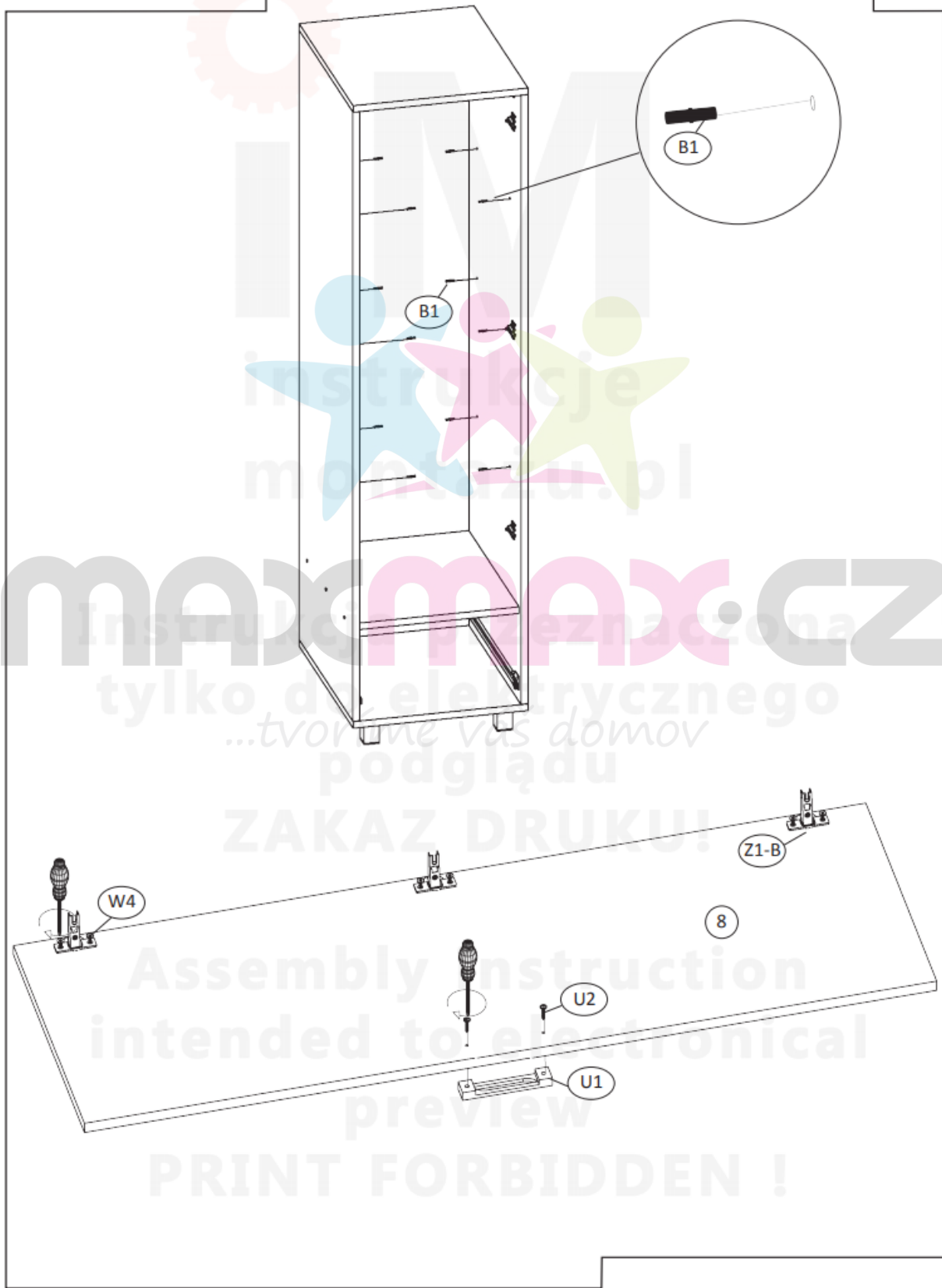

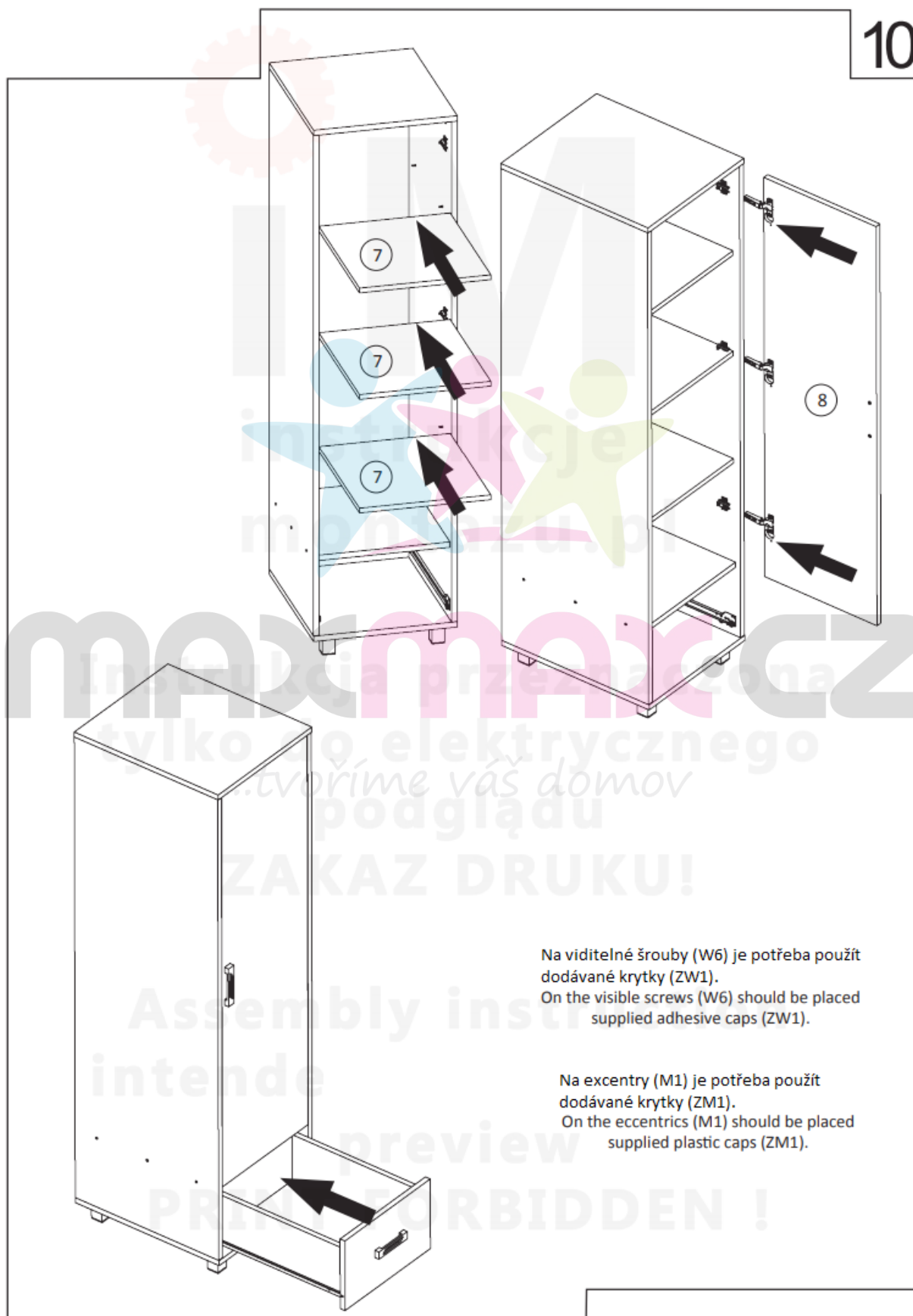

Na viditeľné šrouby (W6) je potreba použiť  
 dodávané krytky (ZW1).

On the visible screws (W6) should be placed  
 supplied adhesive caps (ZW1).

Na excentry (M1) je potreba použiť  
 dodávané krytky (ZM1).

On the eccentrics (M1) should be placed  
 supplied plastic caps (ZM1).

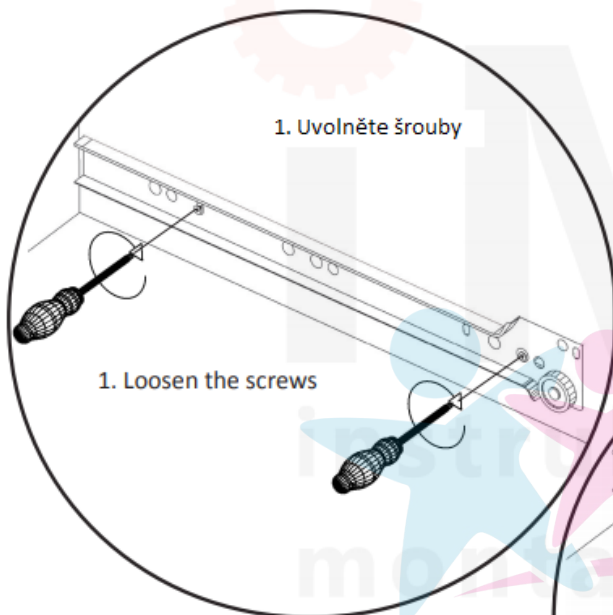

1. Uvolněte šrouby

1. Loosen the screws

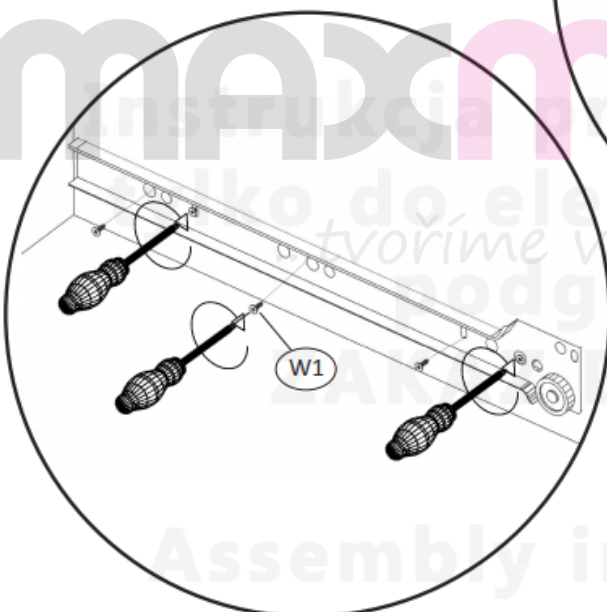

3. Tighten the screws loosened earlier.

4. Slide the drawer and check their positions.

5. If the drawers are mounted properly tighten another 3 screws to stabilize each drawer runner.

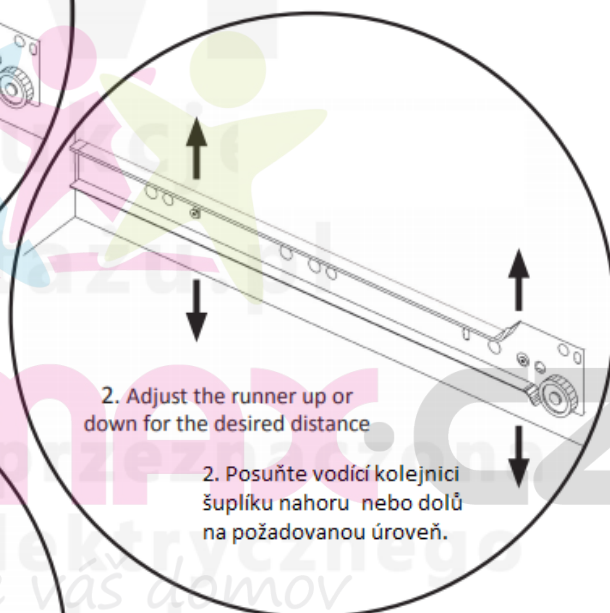

2. Adjust the runner up or down for the desired distance

2. Posuňte vodící kolejnici šuplíku nahoru nebo dolů na požadovanou úroveň.

3. Utáhněte dříve uvolněné šrouby.

4. Zasuňte zásuvku a zkontrolujte její polohu.

5. Pokud je zásuvka správně umístěna, zašroubujte další tři šrouby pro stabilizaci.

**V případě potřeby opakujte jednotlivé kroky.  
If necessary, repeat the steps.**