

























## Dětská skříň ANIMALS TYP 4B (otevírání doprava)

### NÁVOD K MONTÁŽI

#### Příslušenství / Fittings

<b>K1</b>  16 ks / pcs	<b>M2</b>  20 ks / pcs	<b>M1</b>  20 ks / pcs	<b>ZM1</b>  20 ks / pcs	<b>ZW1</b>  14 ks / pcs	<b>T2</b>  16 ks / pcs	<b>G1</b>  20 ks / pcs
<b>W1</b>  Ø3 x 16 24 ks / pcs	<b>B1</b>  12 ks / pcs	<b>W4</b>  Ø4 x 16 28 ks / pcs	<b>W6</b>  Ø6.3 x 50 14 ks / pcs	<b>U1</b>  3 ks / pcs	<b>U2</b>  6 ks / pcs	<b>N1</b>  4 ks / pcs
<b>P1-A</b>  500 mm 2 ks / pcs	<b>P1-B</b>  500 mm 2 ks / pcs	<b>P2-A</b>  500 mm 2 ks / pcs	<b>P2-B</b>  500 mm 2 ks / pcs	<b>Z1-A</b>  3 ks / pcs	<b>Z1-B</b>  3 ks / pcs	
<b>W5</b>  Ø4 x 35 1 ks / pcs	<b>TZ1</b>  1 ks / pcs					

#### Nástroje / Tools

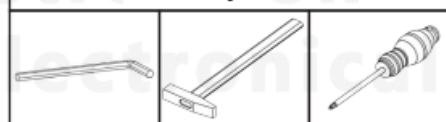

**MONTÁŽ SKŘÍNĚ JE MOŽNÁ POUZE VE DVOU OSOBÁCH**

**VELMI DŮLEŽITÉ!  
ČTĚTE PEČLIVĚ  
NÁVOD SI ULOŽTE PRO POZDĚJŠÍ POUŽITÍ  
UŽIVATELSKÁ PŘÍRUČKA**

1.  
Veškerý obalový materiál odstraňte mimo dosah dětí, tak aby nemohlo dojít k udušení nebo uškrcení.
2.  
Všechny spoje musí být řádně dotaženy, žádná součástka nesmí zůstat volná.
3.  
Nábytek nepoužívejte v případě, že je nějaká součástka poškozená, či chybí.
4.  
Používejte pouze součástky dodané výrobcem.
5.  
Nepokládejte nábytek do blízkosti otevřeného ohně nebo k jiným zdrojům tepla, jako je elektrické nebo plynové topení apod., mohlo by dojít ke vznícení.
6.  
Nábytek musí být připevněn ke stěně pomocí dodané pásky jako ochrana před převrácením.

**VERY IMPORTANT!  
PLEASE READ CAREFULLY  
SAVE FOR FUTURE USE  
USER'S MANUAL**

1.  
To avoid the danger of choking or strangulation keep the package with fittings away from babies and children.
2.  
All connections must be tightened properly and no coupled element can not be loose.
3.  
Do not use the bed when, if any of the elements is damaged or if there is any element missing.
4.  
Use only the elements given by manufacturer.
5.  
Do not place the bed near naked flames or other heat sources such as electric or gas radiators etc., this may cause a fire.
6.  
Do not leave anything in the bed and do not place the crib near any equipment, where a child can prop up its foot or cause danger of strangulation or hanging of a child, e.g. wires, strings of drapers/curtains.

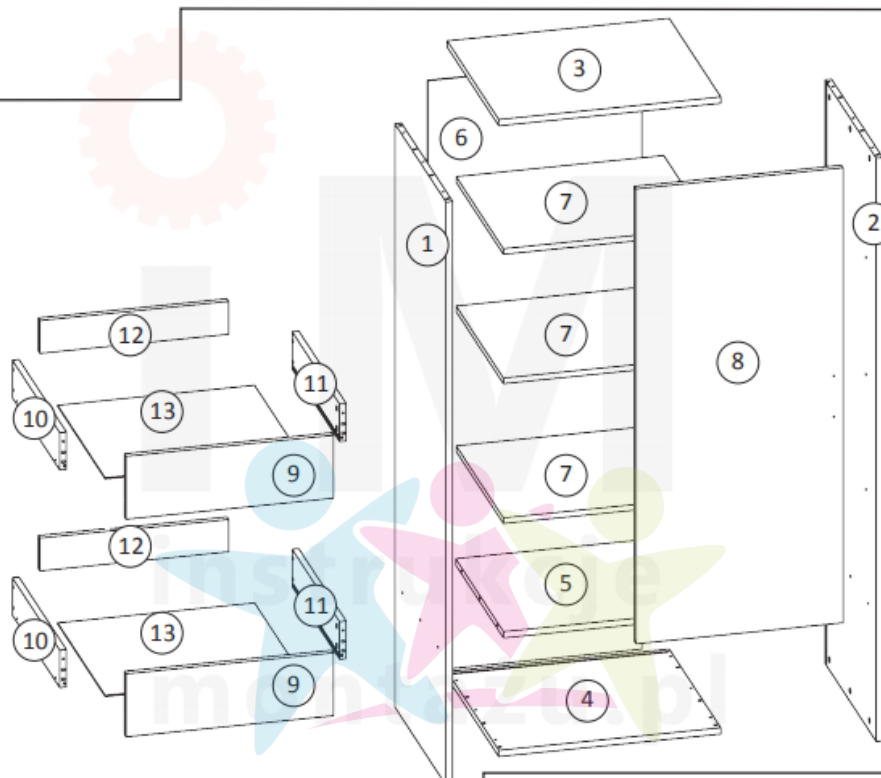

**Balení 1 z 1/ Package 1 of 1**

Číslo položky / item no.	Rozměry (mm) / Dimensions (mm)	Počet / Quantity
1	1672 x 540 x 18	1
2	1672 x 540 x 18	1
3	602 x 542 x 18	1
4	602 x 542 x 18	1
5	564 x 507 x 18	1
6	1690 x 582 x 3	1
7	564 X 497 X 18	3
8	560 x 1290 x 18	1
9	560 x 188 x 18	2
10	500 x 138 x 18	2
11	500 x 138 x 18	2
12	503 x 120 x 18	2
13	521 x 504 x 3	2

Před montáží se ujistěte, že balení obsahuje všechny položky uvedené na této stránce a zkontrolujte, jestli žádná z položek není poškozena. V případě, že některá z položek chybí nebo jeví známky poškození, kontaktujte prodejce tohoto výrobku.

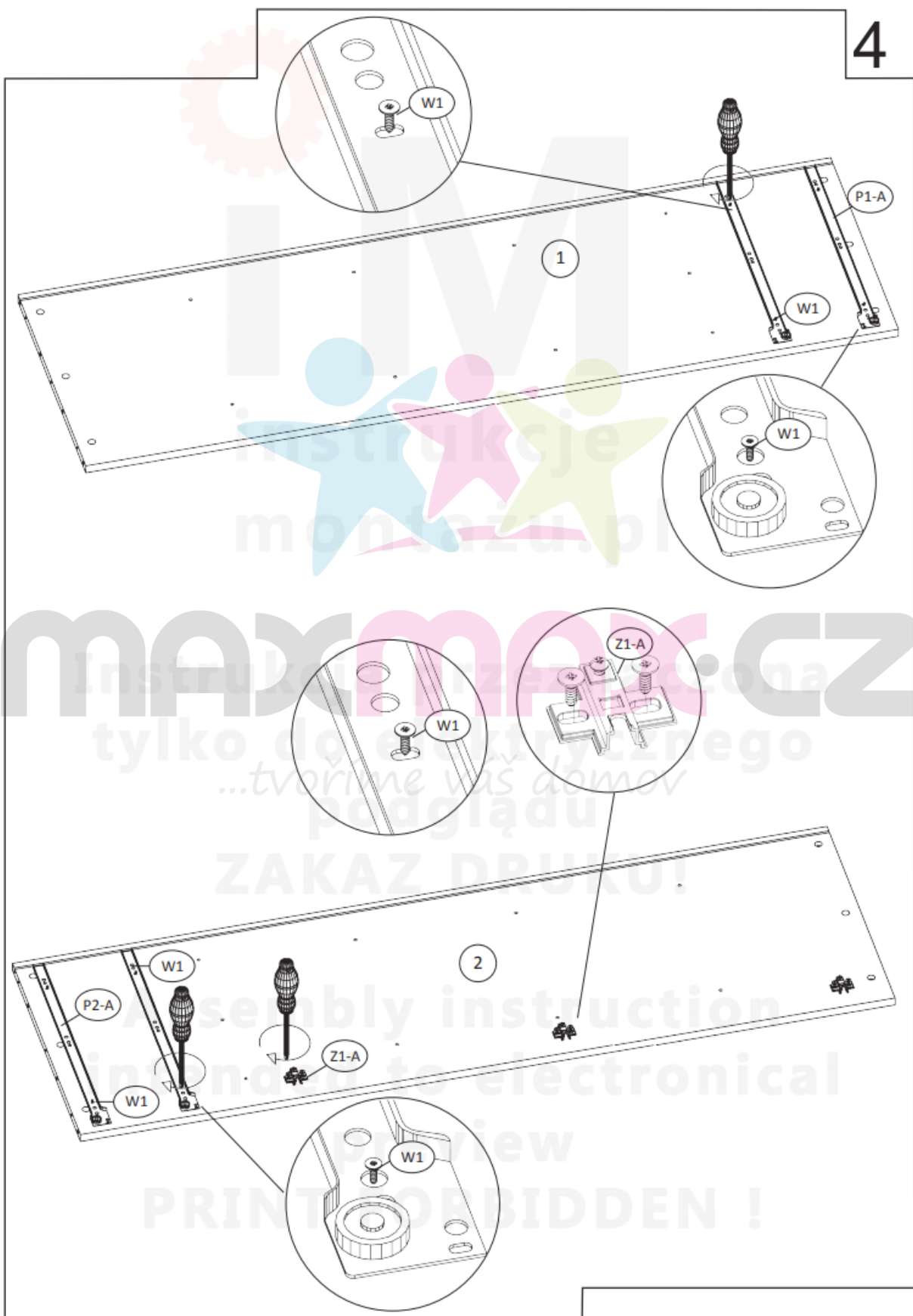
BEFORE ASSEMBLING THE FURNITURE PLEASE CHECK THAT PACKAGES INCLUDE ALL ITEMS LISTED IN THE TABLE ON PAGE NO 3, AND WHETHER THESE ITEMS ARE NOT DAMAGED !!!  
IF MISSING PARTS OR SOME OF THEM ARE DAMAGED, PLEASE CONTACT OUR CUSTOMER SERVICE OFFICE.  
DAMAGES FOUND AFTER ASSEMBLING WILL NOT BE CONSIDERED !!!

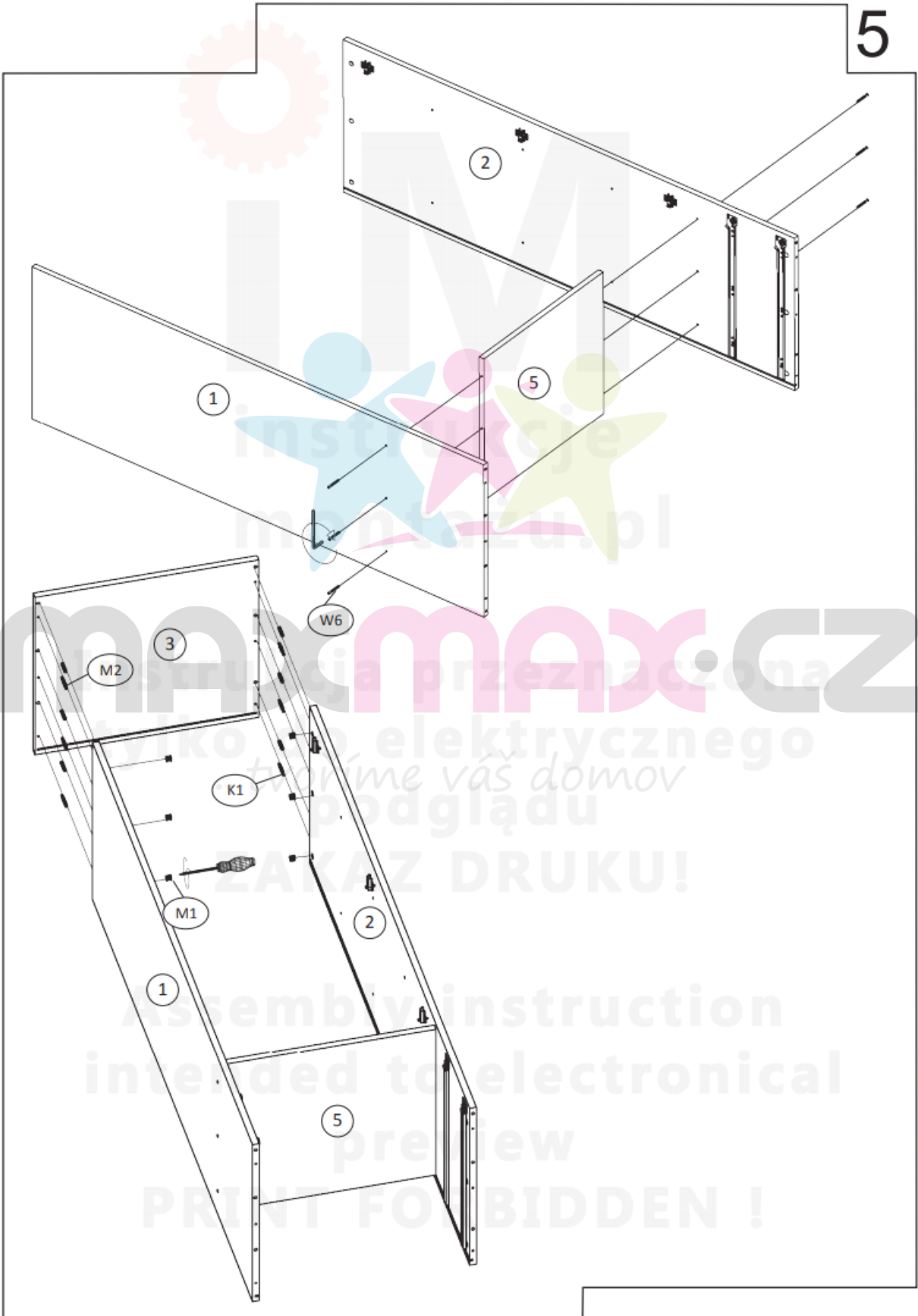



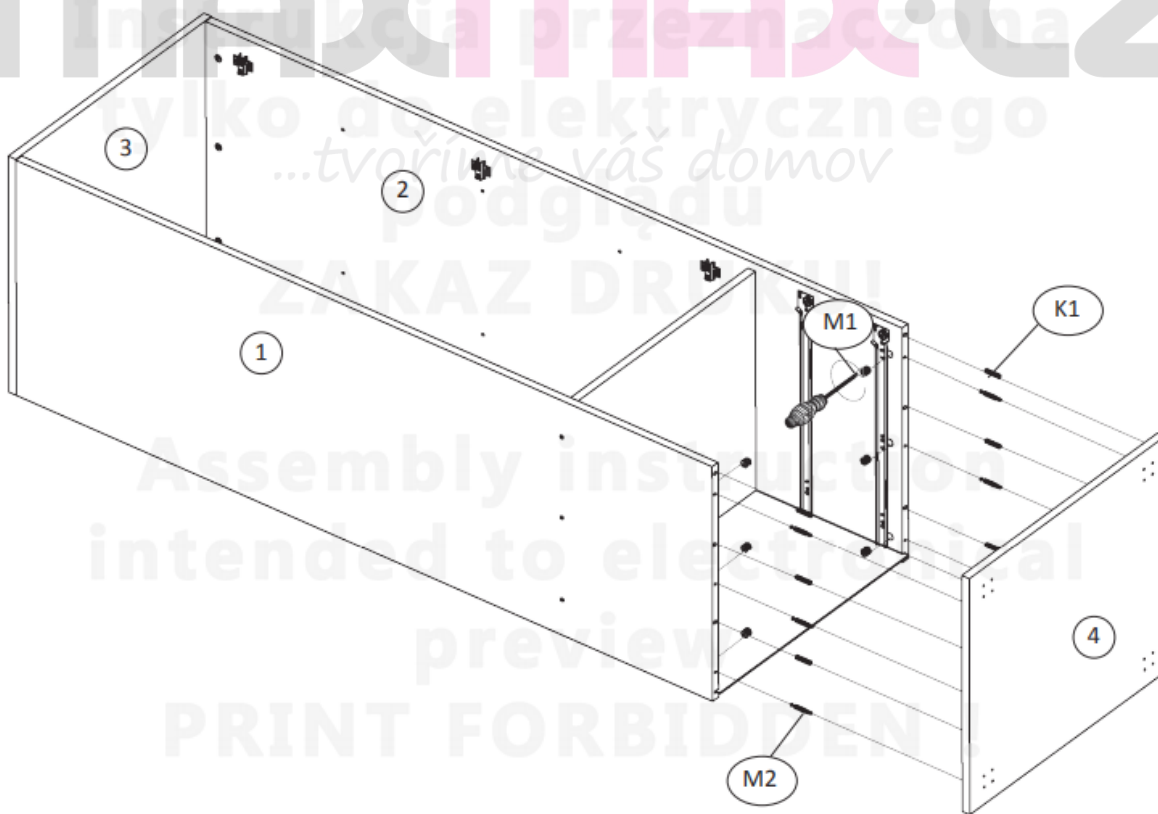
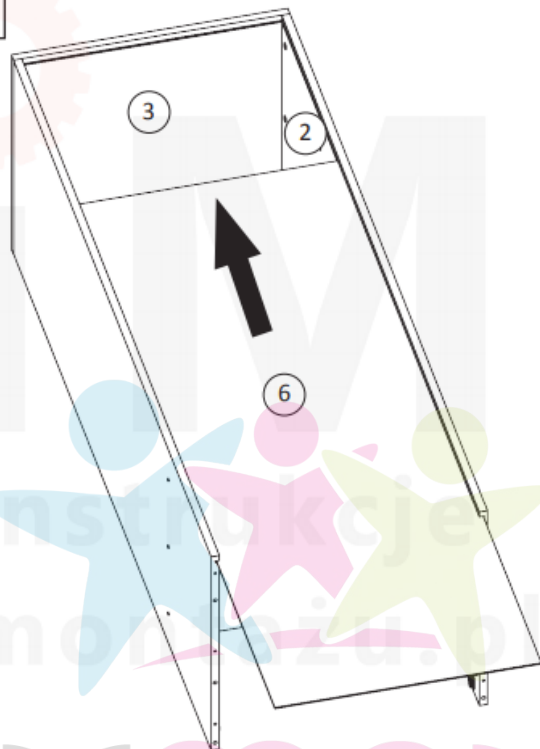

maxmax.cz  
Instrukcja przeznaczona  
tylko do elektrycznego  
...tworzenie wasz domov  
podglądu  
ZAKAZ Druk  
Assembly instruction  
intended to electrical  
preview  
PRINT FORBIDDEN

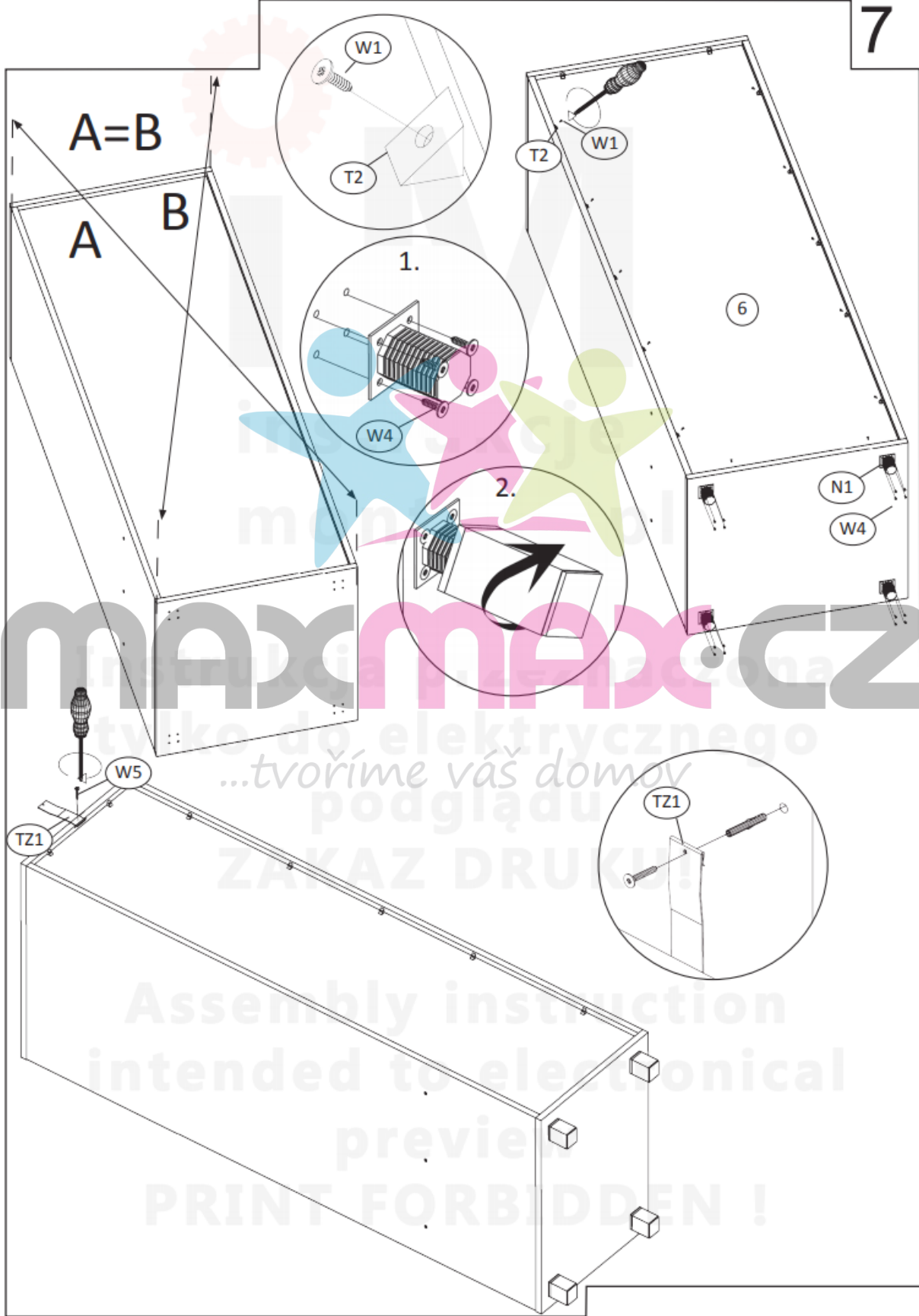

Assembly instruction  
intended to electrical  
preview  
PRINT FORBIDDEN !

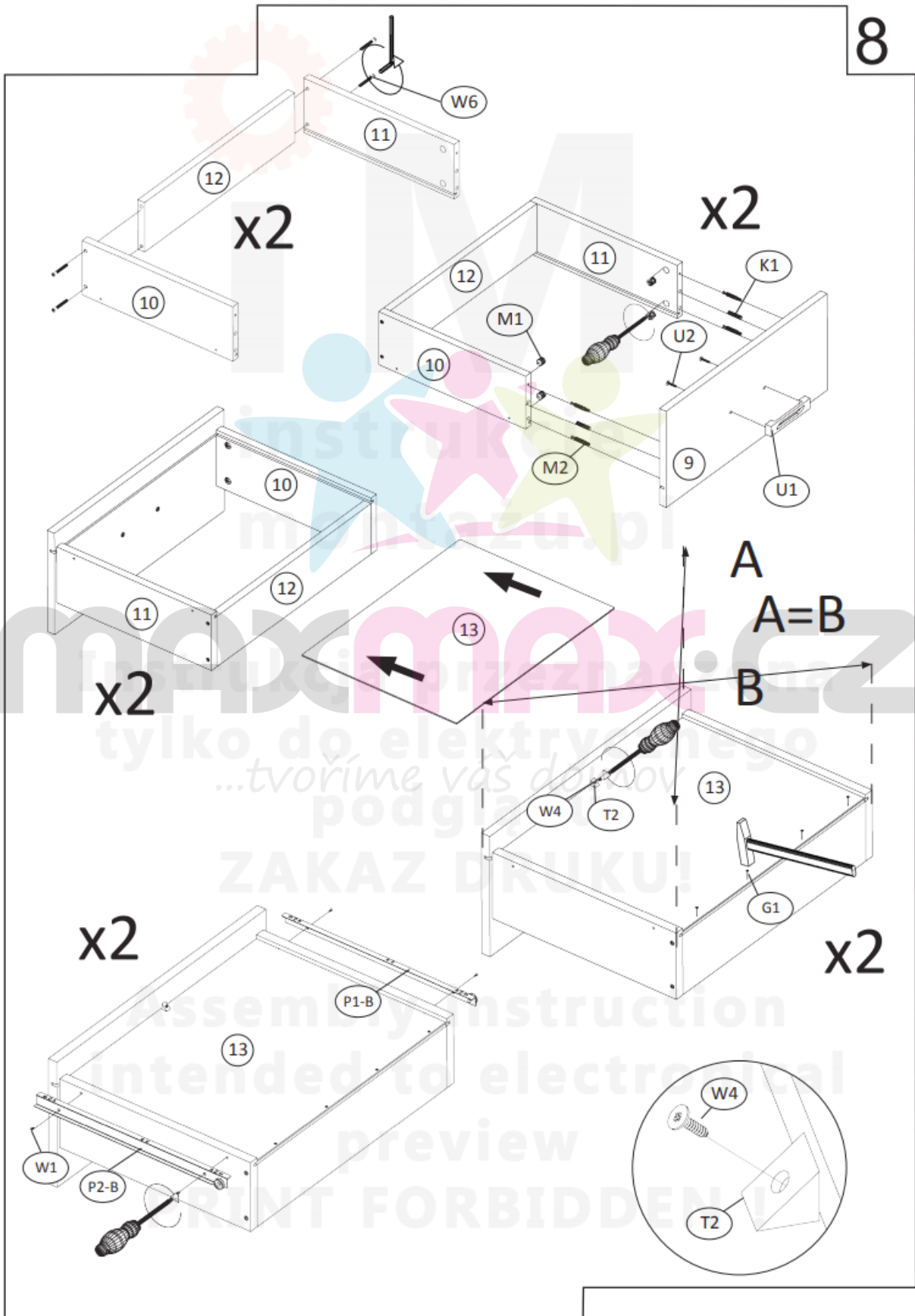



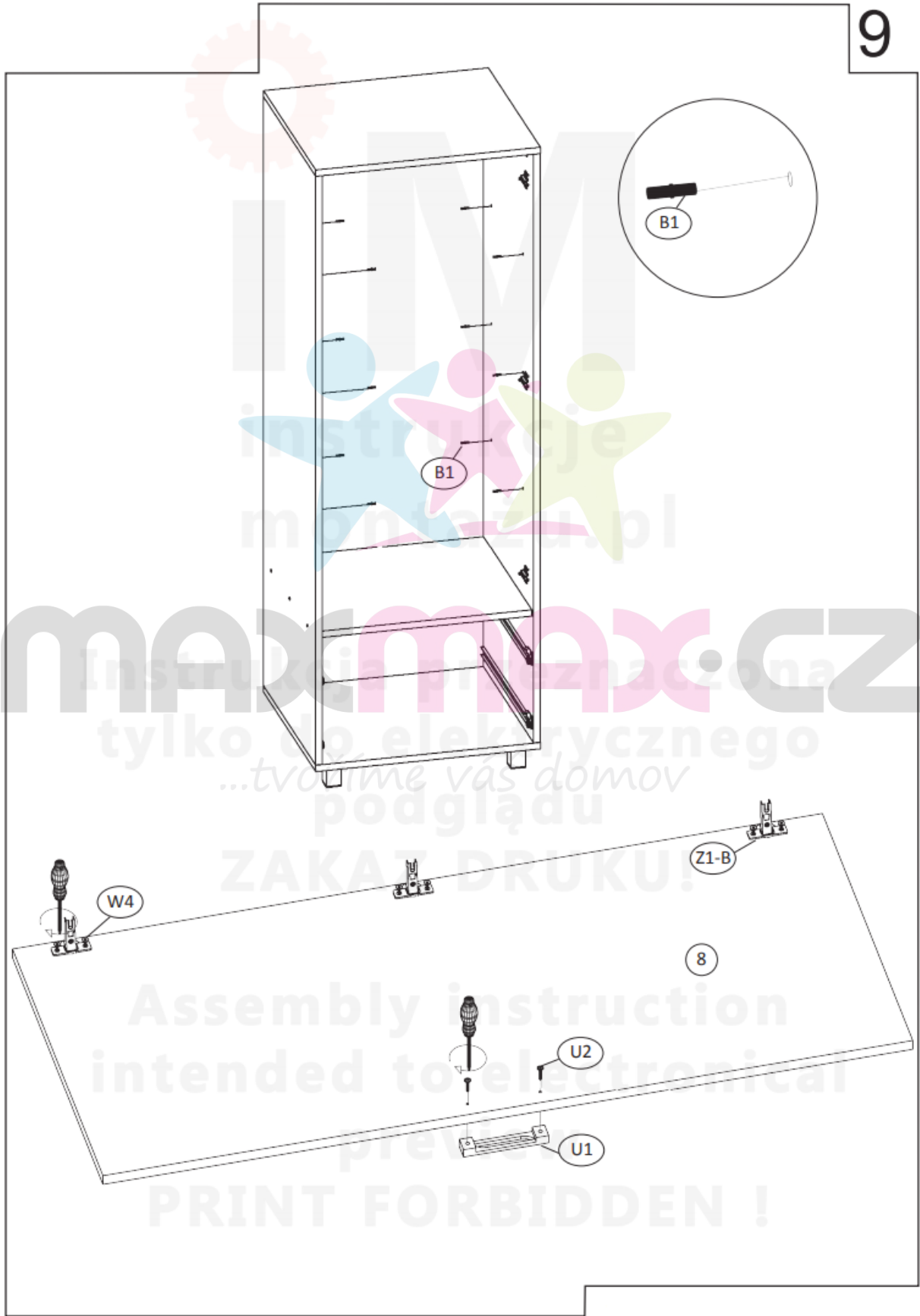

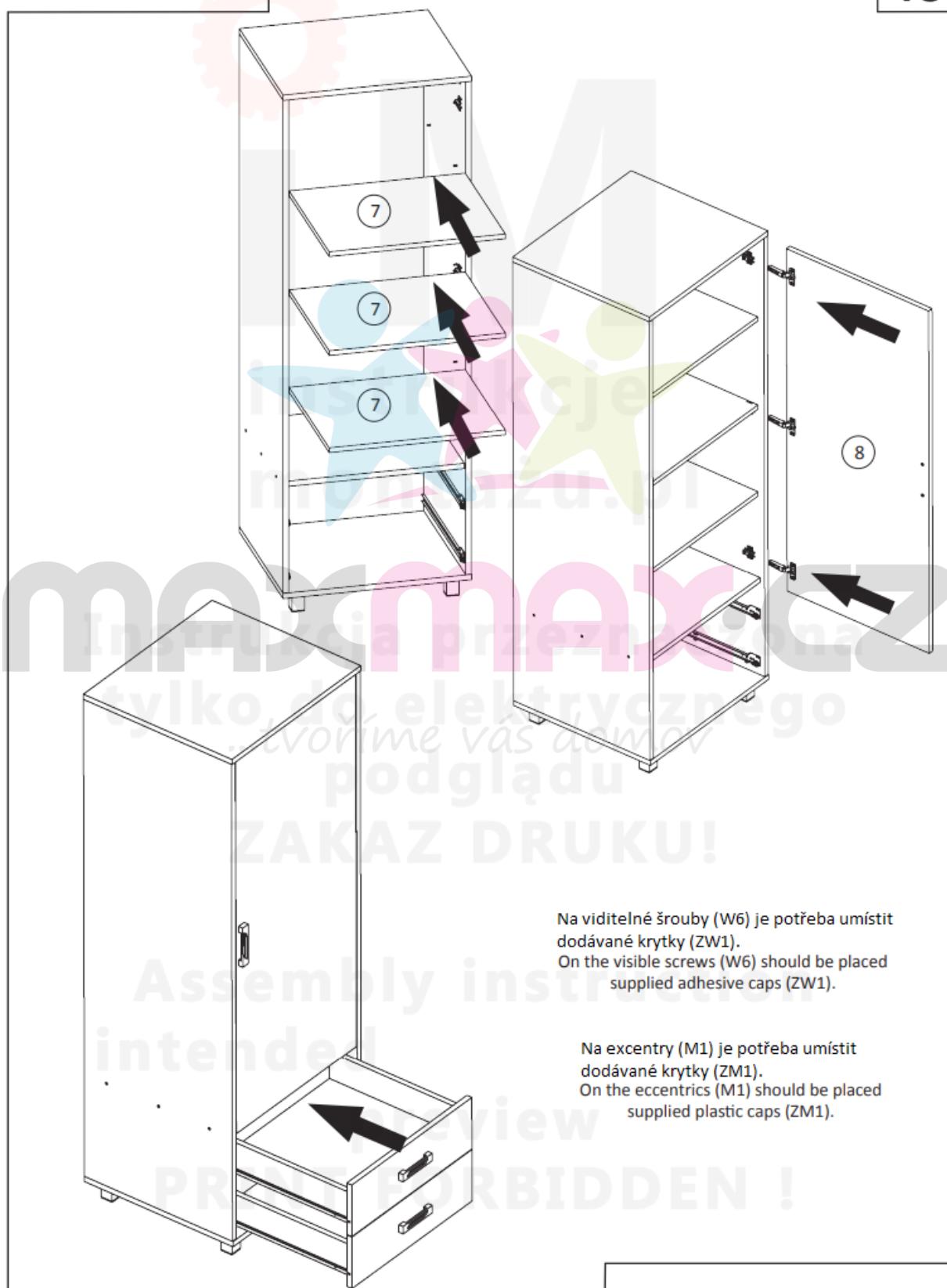

Na viditelné šrouby (W6) je potřeba umístit  
 dodávané krytky (ZW1).  
 On the visible screws (W6) should be placed  
 supplied adhesive caps (ZW1).

Na excentry (M1) je potřeba umístit  
 dodávané krytky (ZM1).  
 On the eccentrics (M1) should be placed  
 supplied plastic caps (ZM1).

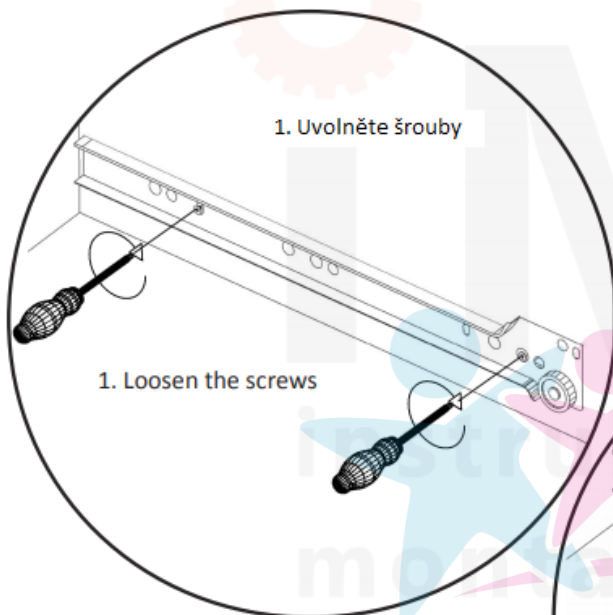

1. Uvolněte šrouby

1. Loosen the screws

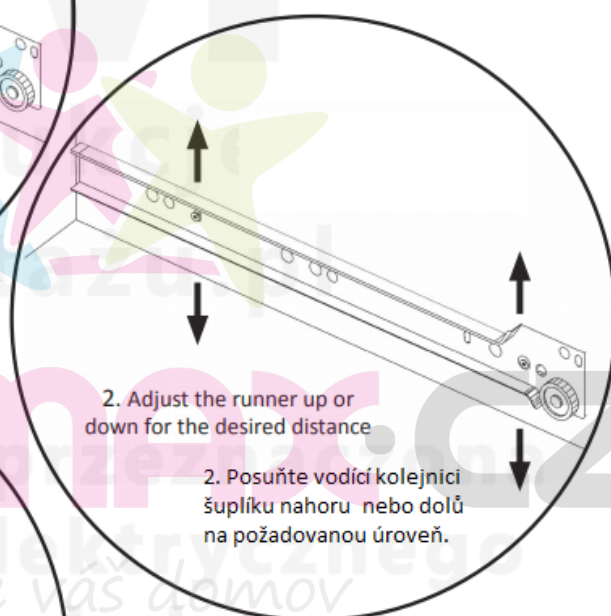

2. Adjust the runner up or down for the desired distance

2. Posuňte vodící kolejnici šuplíku nahoru nebo dolů na požadovanou úroveň.

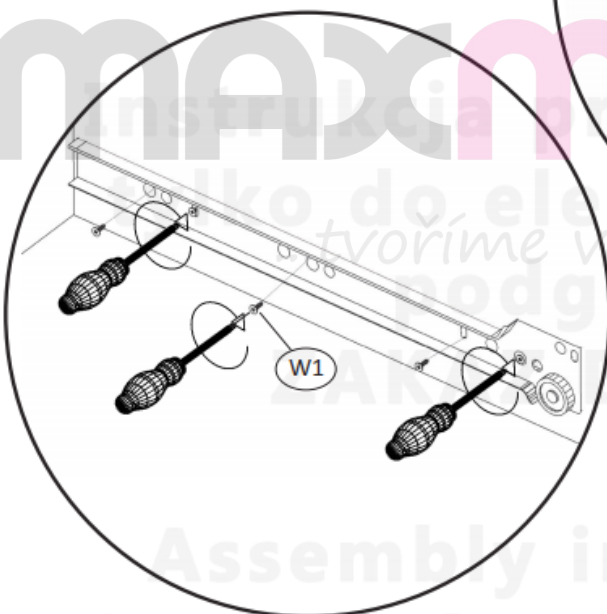

3. Tighten the screws loosened earlier.

3. Utáhněte dříve uvolněné šrouby.

4. Slide the drawer and check their positions.

4. Zasuňte zásuvku a zkontrolujte její polohu.

5. If the drawers are mounted properly tighten another 3 screws to stabilize each drawer runner.

5. Pokud je zásuvka správně umístěna, zašroubujte další tři šrouby pro stabilizaci.

**V případě potřeby opakujte jednotlivé kroky.  
If necessary, repeat the steps.**

Assembly instruction

intended to electrical

previ

PRINT FORBIDDEN!