



















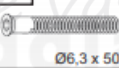







Dětská skříň ANIMALS TYP 6B

NÁVOD K MONTÁŽI

Příslušenství / Fittings						
K1 	M2 	M1 	ZM1 	ZW1 	T2 	G1 
16 ks / pcs	20 ks / pcs	20 ks / pcs	20 ks / pcs	14 ks / pcs	18 ks / pcs	10 ks / pcs
W1  Ø3 x 16	B1 	W4  Ø4 x 16	W6  Ø6,3 x 50	U1 	U2 	N1 
24 ks / pcs	12 ks / pcs	40 ks / pcs	20 ks / pcs	6 ks / pcs	12 ks / pcs	4 ks / pcs
P1-A  500 mm	P1-B  500 mm	P2-A  500 mm	P2-B  500 mm	T1 	Z1-A 	Z1-B 
2 ks / pcs	2 ks / pcs	2 ks / pcs	2 ks / pcs	6 ks / pcs	6 ks / pcs	6 ks / pcs
D1 	D2  403 mm	W5  Ø4 x 35	TZ1 			
2 ks / pcs	1 ks / pcs	1 ks / pcs	1 ks / pcs			

Nástroje/ Tools		
		

**VELMI DŮLEŽITÉ!
ČTĚTE PEČLIVĚ
NÁVOD SI ULOŽTE PRO POZDĚJŠÍ POUŽITÍ
UŽIVATELSKÁ PŘÍRUČKA**

1.
Veškerý obalový materiál odstraňte mimo dosah dětí, tak aby nemohlo dojít k udušení nebo uškrcení.

2.
Všechny spoje musí být řádně dotaženy, žádná součástka nesmí zůstat volná.

3.
Nábytek nepoužívejte v případě, že je nějaká součástka poškozená, či chybí.

4.
Používejte pouze součástky dodané výrobcem.

5.
Nepokládejte nábytek do blízkosti otevřeného ohně nebo k jiným zdrojům tepla, jako je elektrické nebo plynové topení apod., mohlo by dojít ke vznícení.

**VERY IMPORTANT!
PLEASE READ CAREFULLY
SAVE FOR FUTURE USE
USER'S MANUAL**

1.
To avoid the danger of choking or strangulation keep the package with fittings away from babies and children.

2.
All connections must be tightened properly and no coupled element can not be loose.

3.
Do not use the bed when, if any of the elements is damaged or if there is any element missing.

4.
Use only the elements given by manufacturer.

5.
Do not place the bed near naked flames or other heat sources such as electric or gas radiators etc., this may cause a fire.

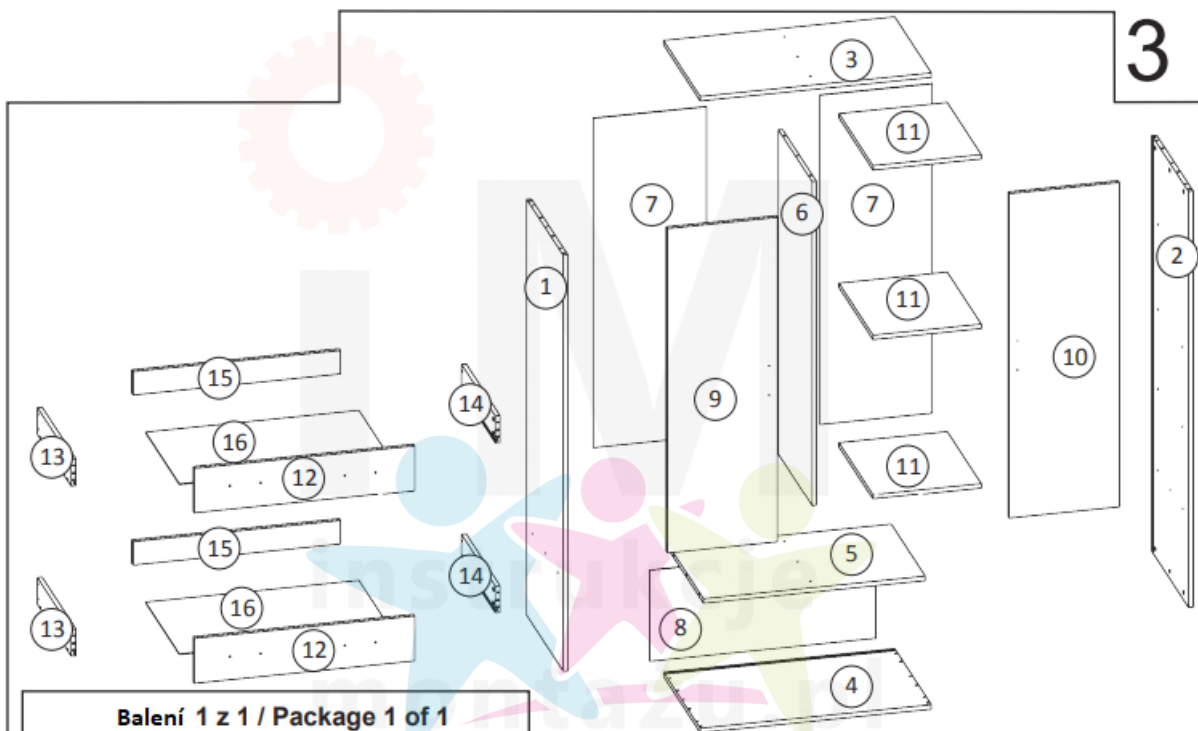

Balení 1 z 1 / Package 1 of 1

Číslo položky / item no.	Rozměry(mm)/ Dimensions (mm)	Počet / Quantity
1	1672 x 540 x 18	1
2	1672 x 540 x 18	1
3	884 x 542 x 18	1
4	884 x 542 x 18	1
5	846 x 507 x 18	1
6	1289 x 540 x 18	1
7	1298 x 431 x 3	2
8	392 x 864 x 3	1
9	420 x 1290 x 18	1
10	420 x 1290 x 18	1
11	414 x 497 x 18	3
12	842 x 188 x 18	2
13	500 x 138 x 18	2
14	500 x 138 x 18	2
15	785 x 120 x 18	2
16	803 x 504 x 3	2

Před montáží se ujistěte, že balení obsahuje všechny položky uvedené na této stránce a zkontrolujte, jestli žádná z položek není poškozena. V případě, že některá z položek chybí nebo jeví známky poškození, kontaktujte prodejce tohoto výrobku.

BEFORE ASSEMBLING THE FURNITURE PLEASE CHECK THAT PACKAGES INCLUDE ALL ITEMS LISTED IN THE TABLE ON PAGE NO 3, AND WHETHER THESE ITEMS ARE NOT DAMAGED !!!
IF MISSING PARTS OR SOME OF THEM ARE DAMAGED, PLEASE CONTACT OUR CUSTOMER SERVICE OFFICE.
DAMAGES FOUND AFTER ASSEMBLING WILL NOT BE CONSIDERED !!!

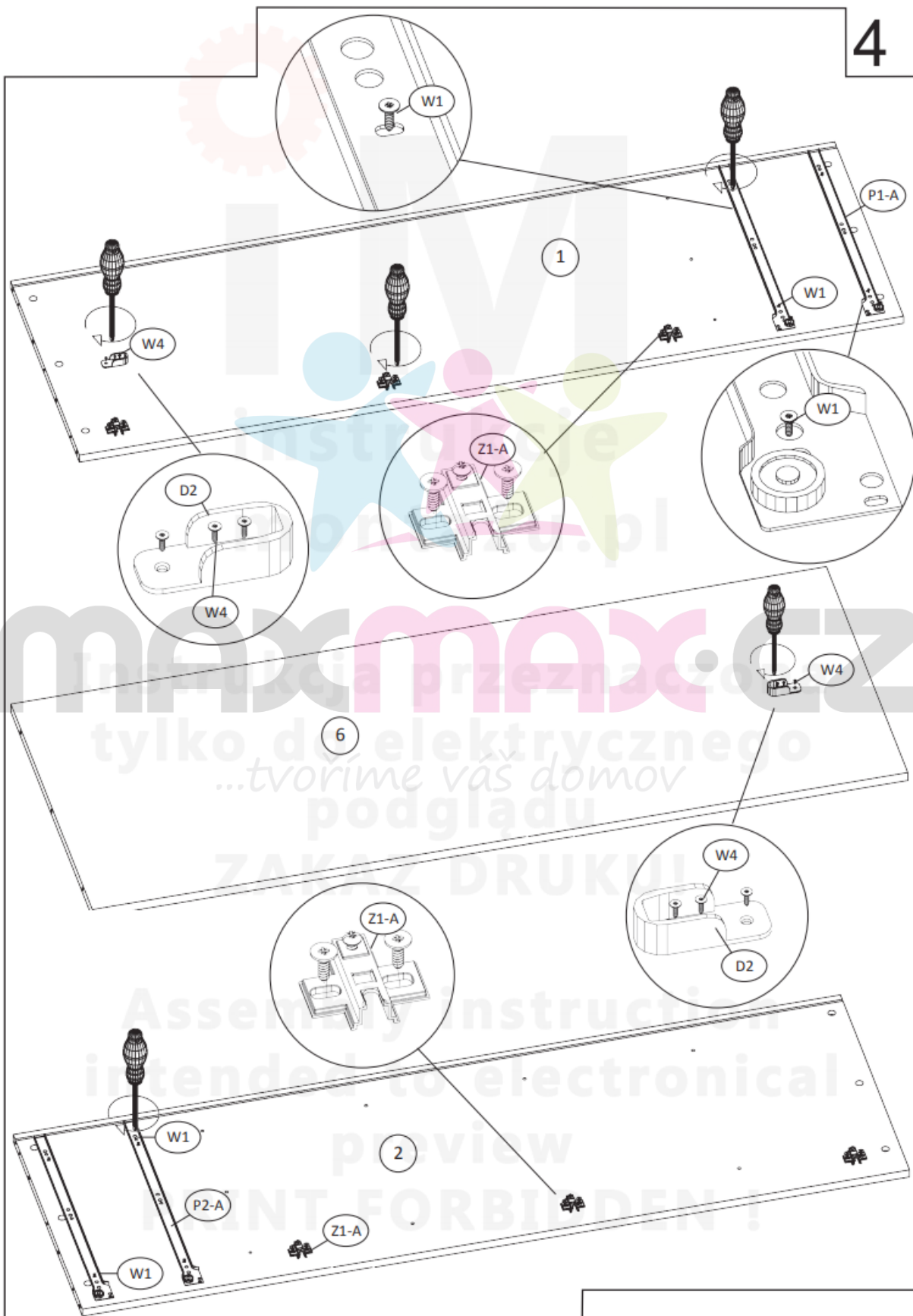

5

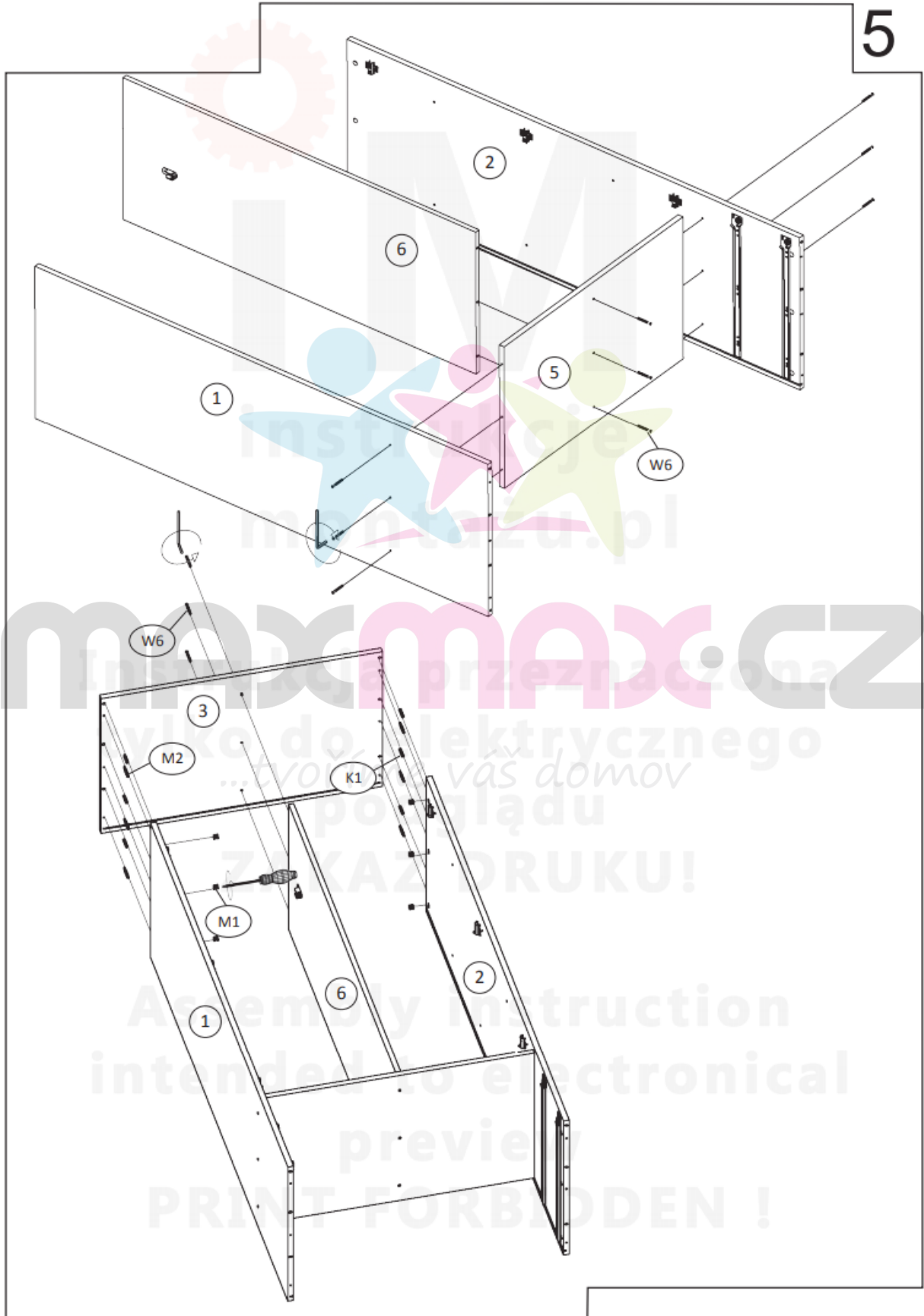

maxmax.cz
przeznaczona
do elektrycznego
...trój...
vaš domov
po...
ZAKAZ DRUKU!
Assembly instruction
intended to be printed
preview
PRINT FORBIDDEN!

6

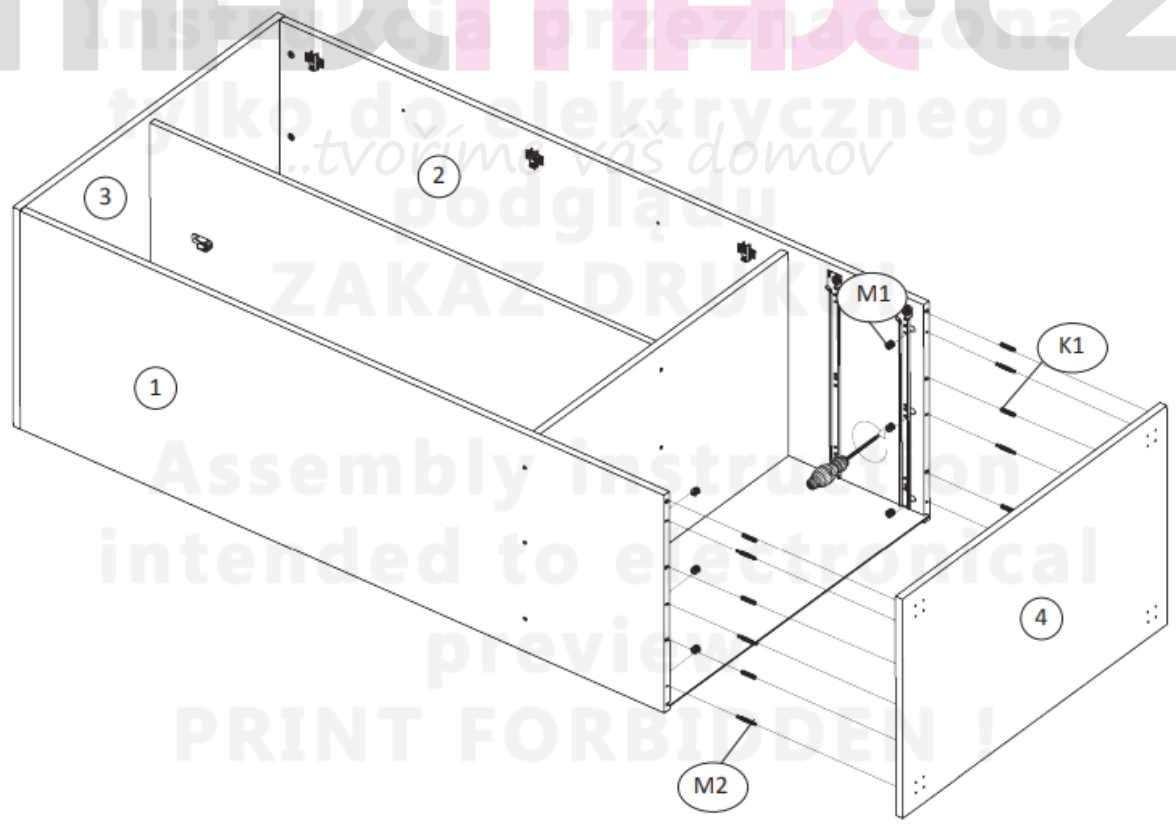
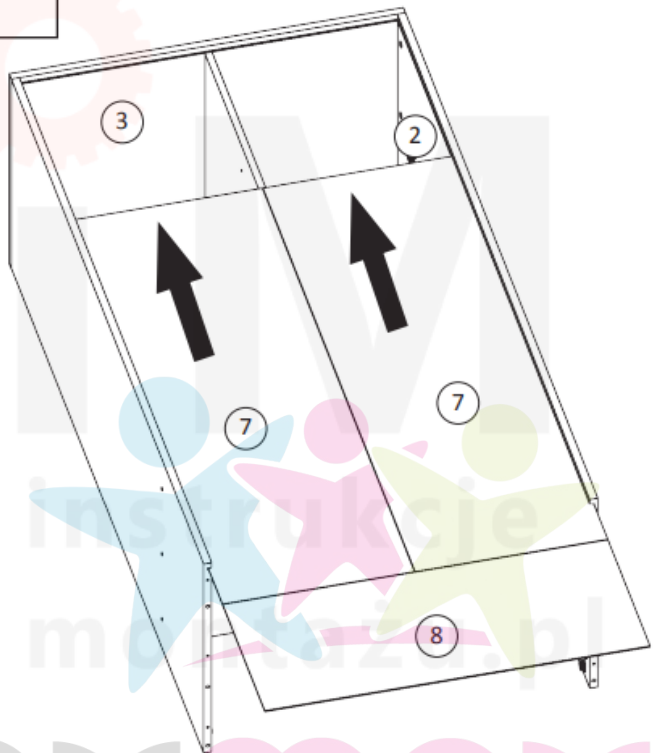

maxmax.cz
Instrukcja przeznaczona
tylko do elektrycznego
podglądu
ZAKAZ Druk
Assembly instruction
intended to electrical
preview
PRINT FORBIDDEN I

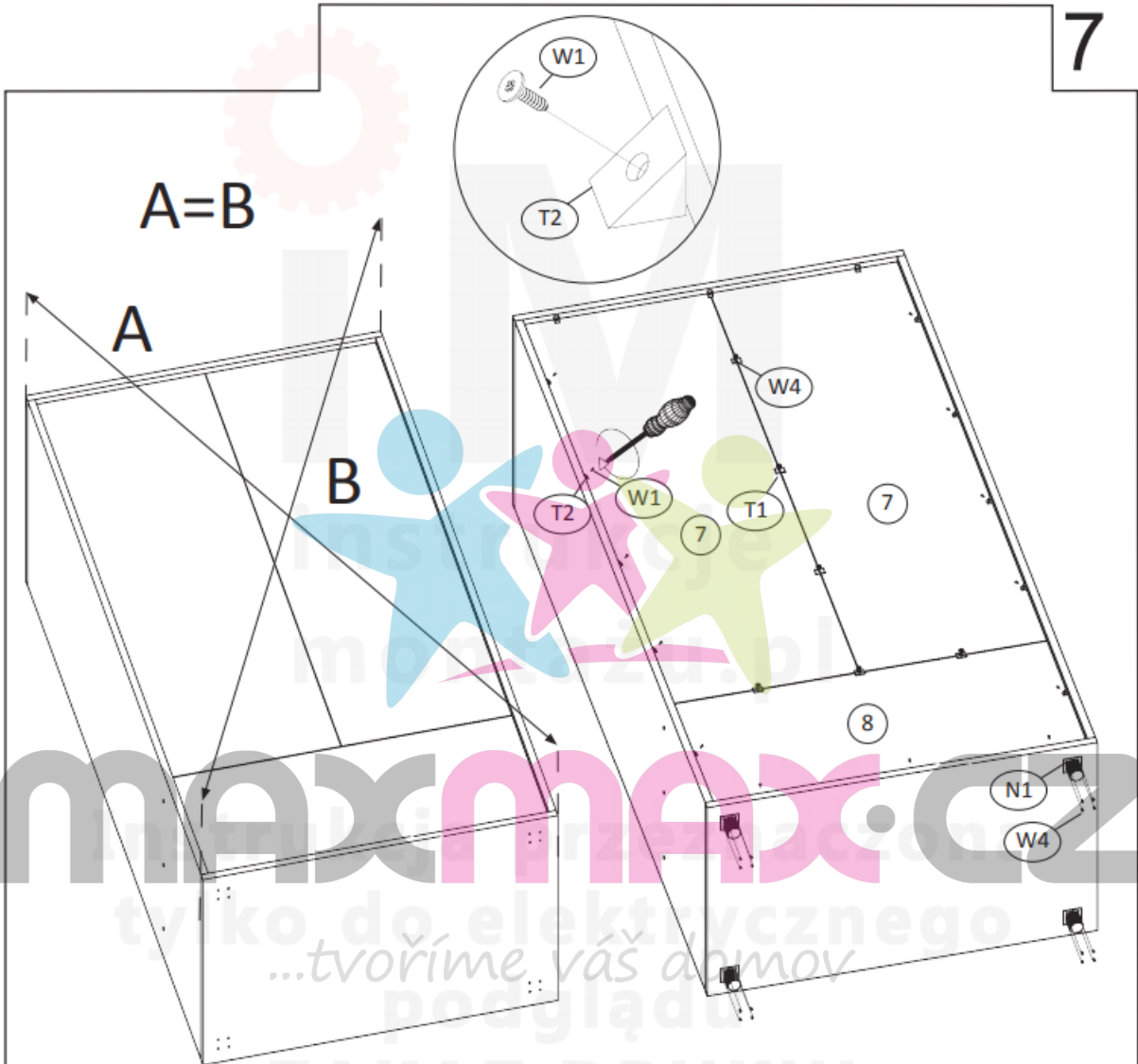

tylko do elektrycznego podglądu

ZAKAZ DRUKU!

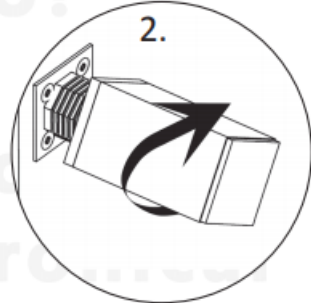
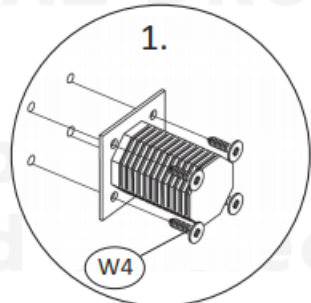
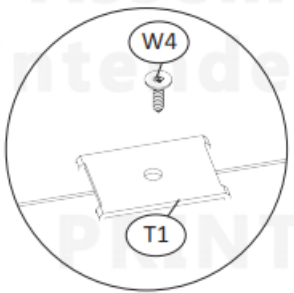

Assembly intended for electronic preview PRINT FORBIDDEN!

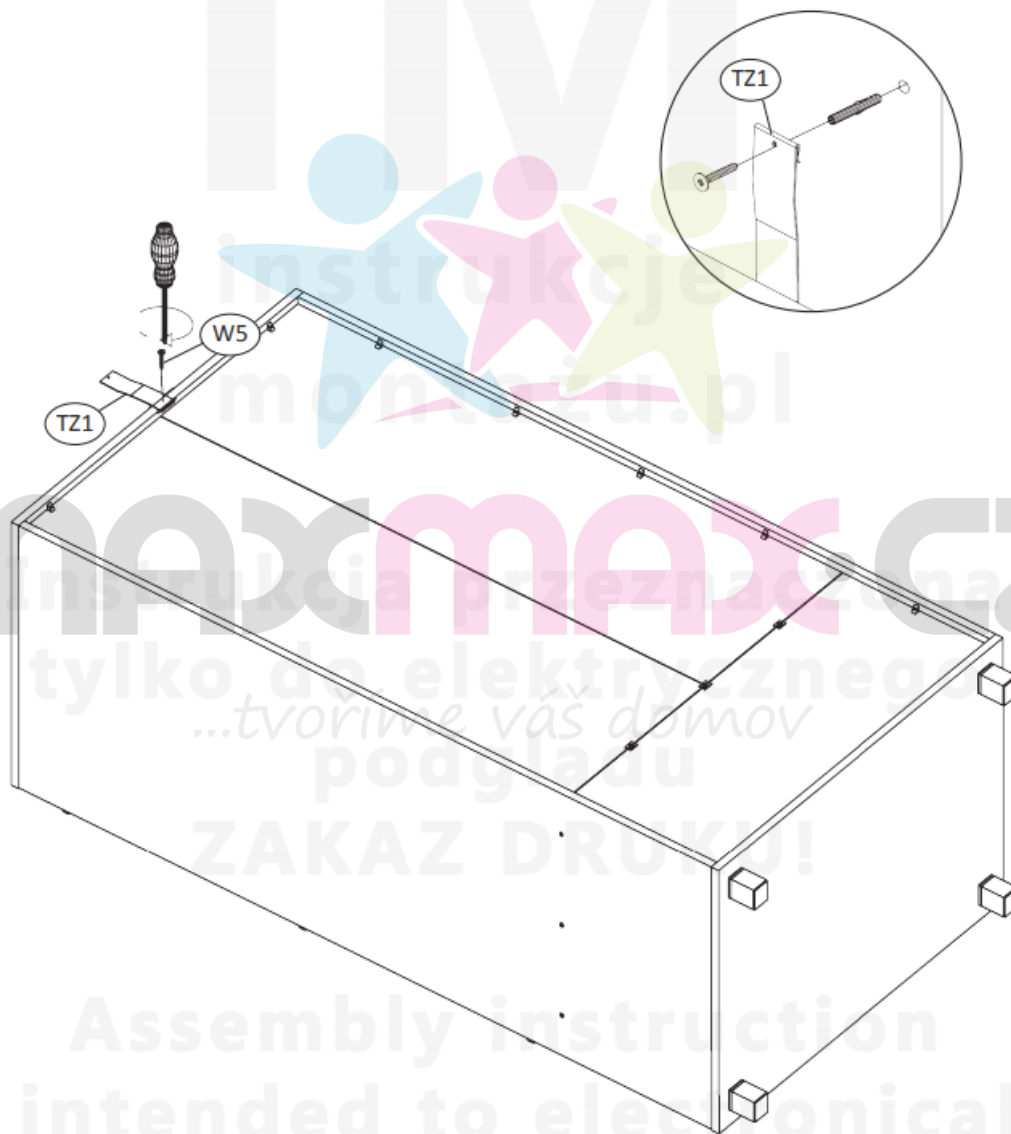

Instrukcja przeznaczona
tylko do elektrycznego
...tworíme váš domov
podglądu
ZAKAZ DRUKU!
Assembly instruction
intended to electrical
preview
PRINT FORBIDDEN !

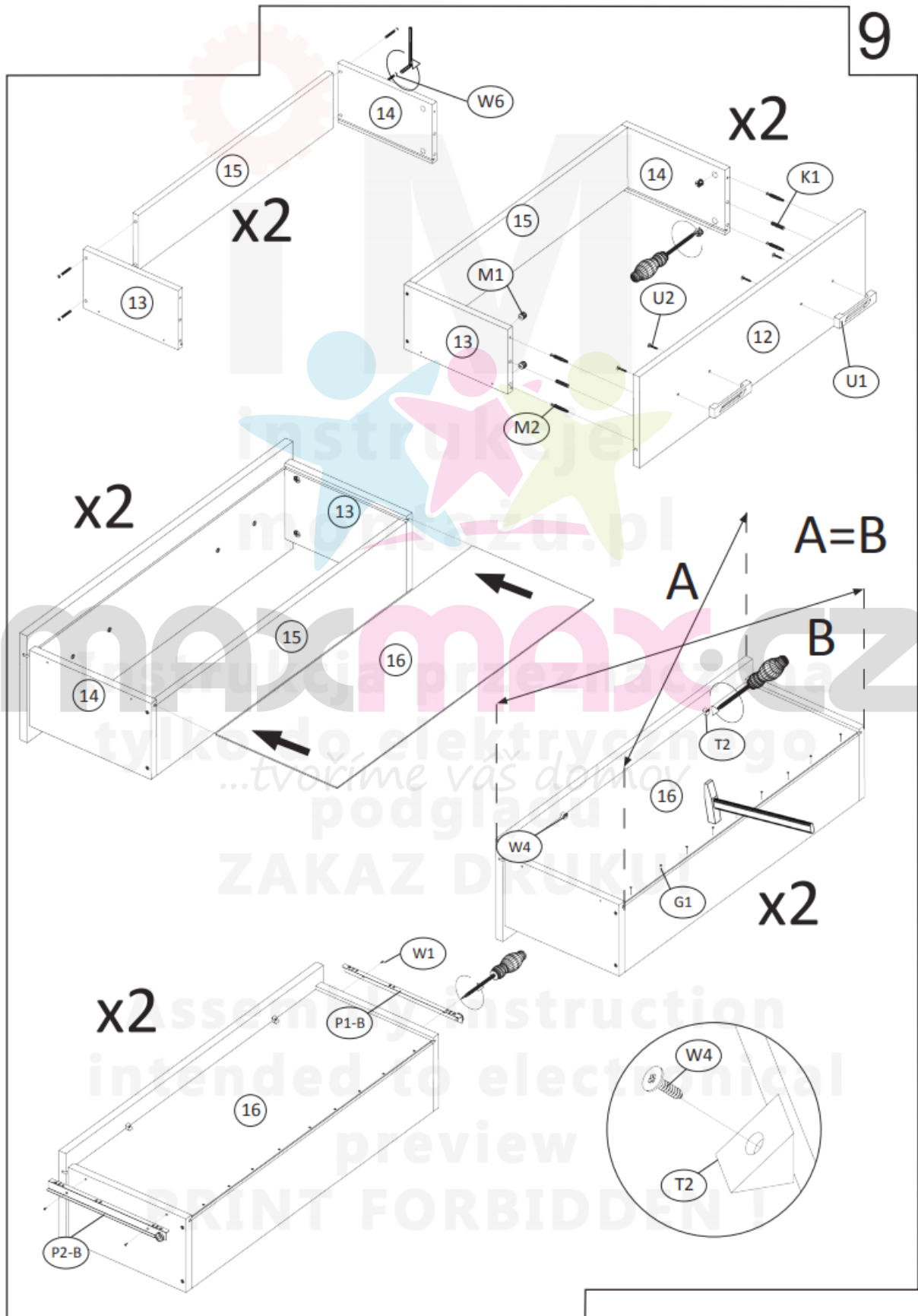

10

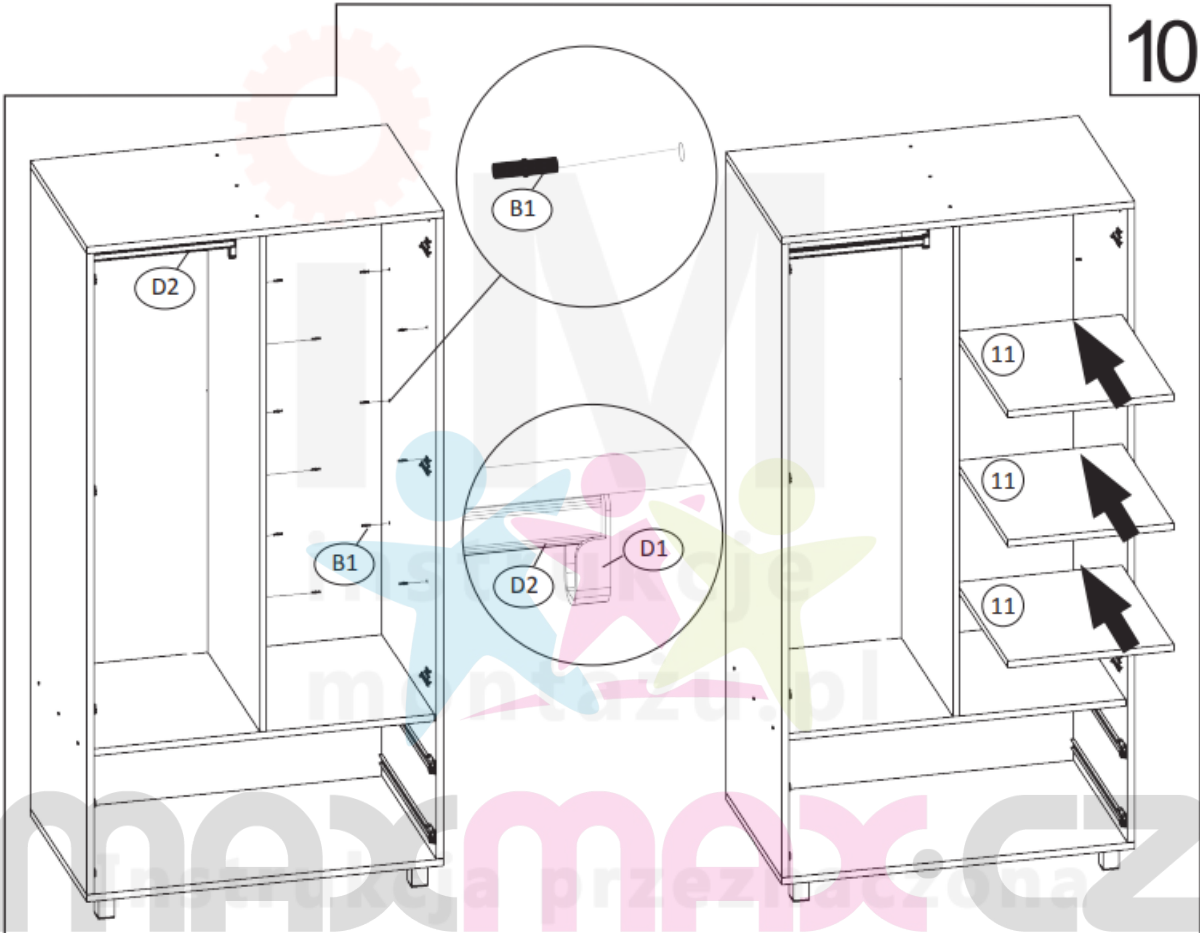

maxmax.cz

tylko do elektrycznego
...tvoríme váš domov
podglądu

x2

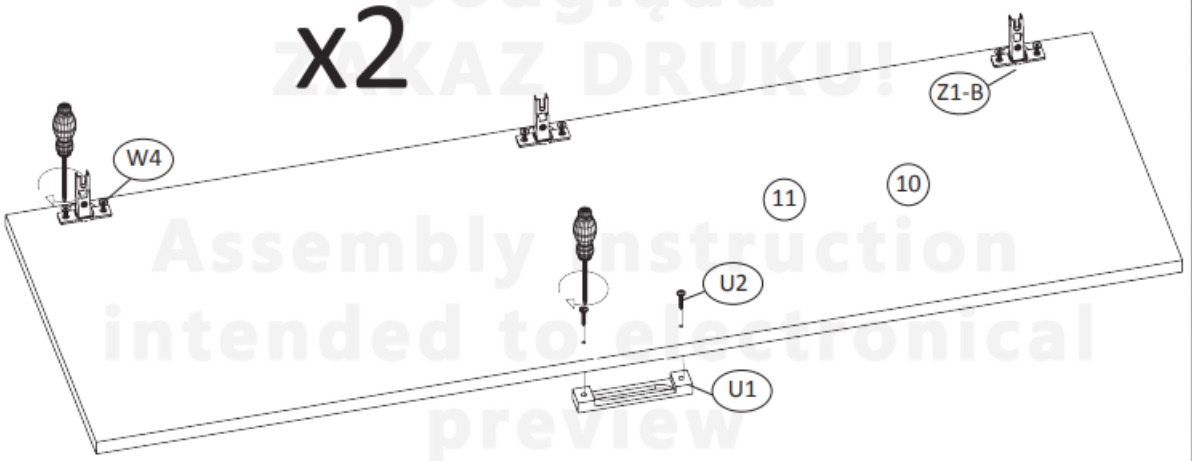

Assembly instruction
intended to electrical
preview
PRINT FORBIDDEN !

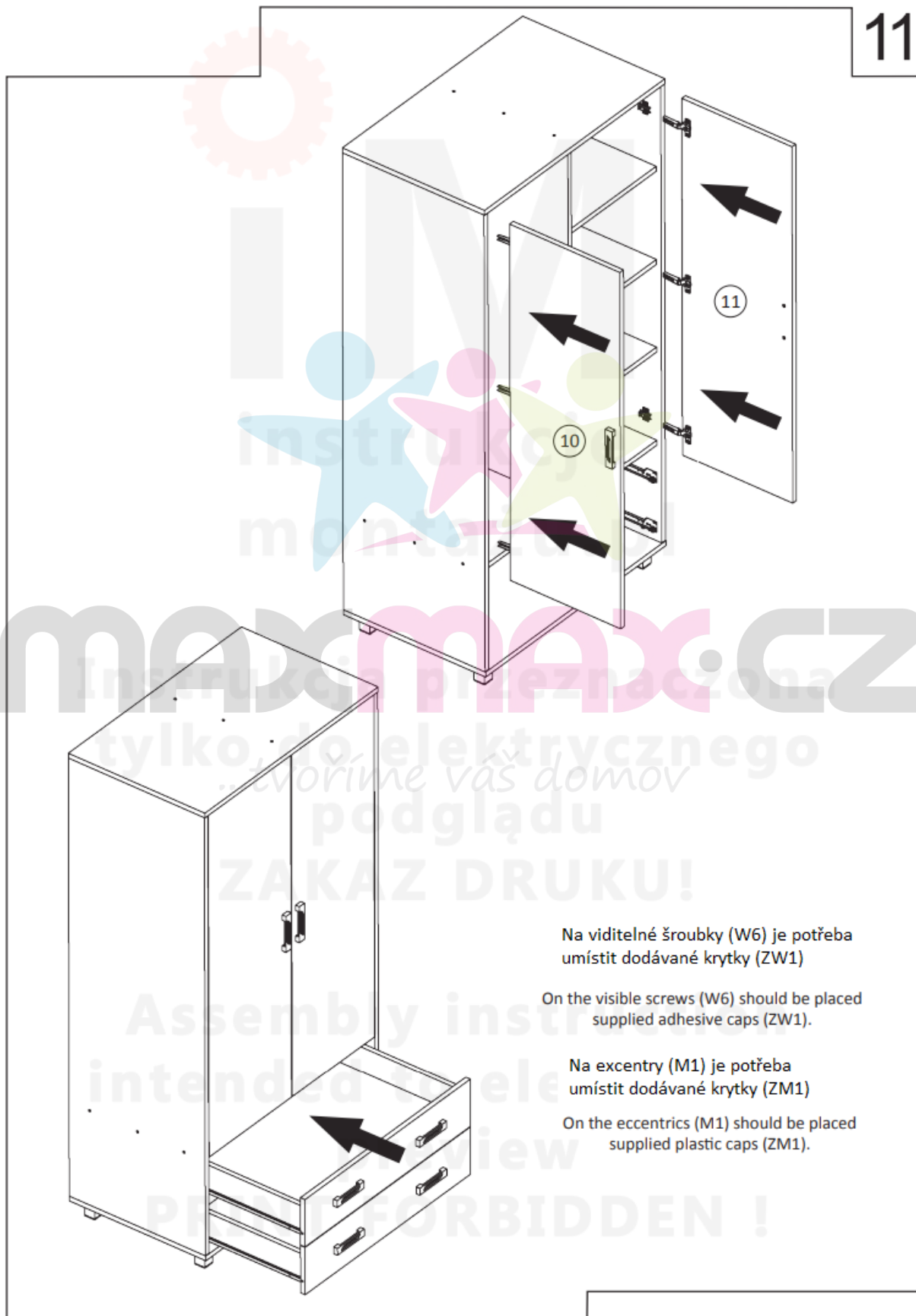

Na viditelné šroubky (W6) je potřeba umístit dodávané krytky (ZW1)

On the visible screws (W6) should be placed supplied adhesive caps (ZW1).

Na excentry (M1) je potřeba umístit dodávané krytky (ZM1)

On the eccentrics (M1) should be placed supplied plastic caps (ZM1).

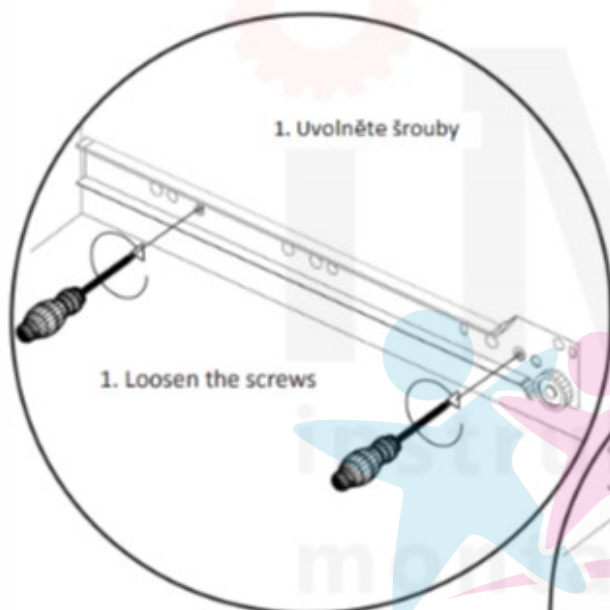

1. Uvolněte šrouby

1. Loosen the screws

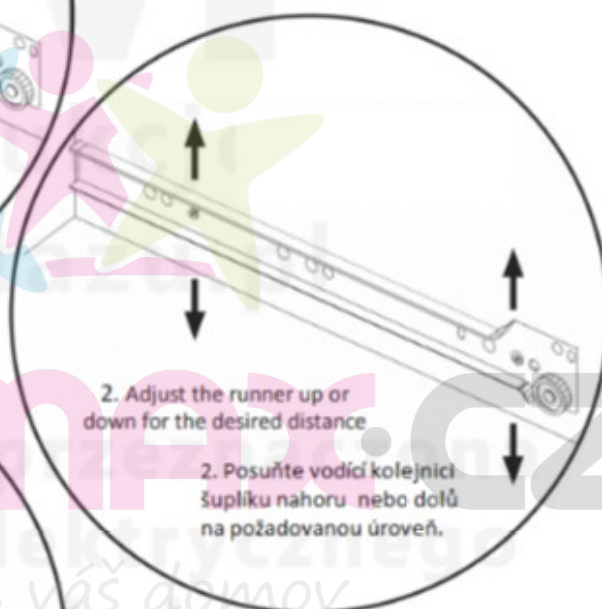

2. Adjust the runner up or down for the desired distance

2. Posuňte vodící kolejnici šuplíku nahoru nebo dolů na požadovanou úroveň.

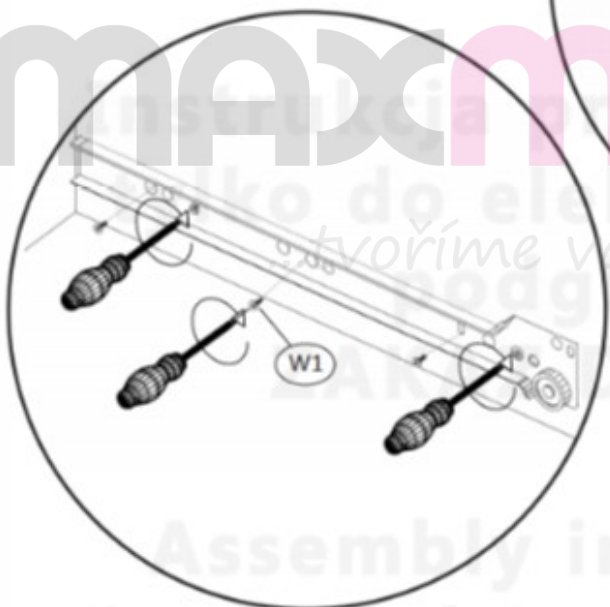

3. Tighten the screws loosened earlier.

4. Slide the drawer and check their positions.

5. If the drawers are mounted properly tighten another 3 screws to stabilize each drawer runner.

3. Utáhněte dříve uvolněné šrouby.

4. Zasuňte zásuvku a zkontrolujte její polohu.

5. Pokud je zásuvka správně umístěna, zašroubujte další tři šrouby pro stabilizaci.

V případě potřeby opakujte jednotlivé kroky.

If necessary, repeat the steps.