





















## Dětská skříň ANIMALS TYP 7A

### NÁVOD K MONTÁŽI

Příslušenství / Fittings						
						
12 ks / pcs	12 ks / pcs	12 ks / pcs	12 ks / pcs	6 ks / pcs	14 ks / pcs	4 ks / pcs
						
6 ks / pcs	2 ks / pcs	1 ks / pcs 835 mm	6 ks / pcs Ø6,3 x 50	4 ks / pcs	8 ks / pcs	4 ks / pcs
						
40 ks / pcs Ø4 x 16	10 ks / pcs	10 ks / pcs	1 ks / pcs Ø4 x 35	1 ks / pcs	1 ks / pcs 1266 mm	

Assembly instruction  
intended to electrical  
preview

Nástroje / Tools		
		

MONTÁŽ SKŘÍNĚ JE MOŽNÁ POZE VE DVOU OSOBÁCH

**VELMI DŮLEŽITÉ!  
ČTĚTE PEČLIVĚ  
NÁVOD SI ULOŽTE PRO POZDĚJŠÍ POUŽITÍ  
UŽIVATELSKÁ PŘÍRUČKA**

1.  
Veškerý obalový materiál odstraňte mimo dosah dětí, tak aby nemohlo dojít k udušení nebo uškrcení.

2.  
Všechny spoje musí být řádně dotaženy, žádná součástka nesmí zůstat volná.

3.  
Nábytek nepoužívejte v případě, že je nějaká součástka poškozená, či chybí.

4.  
Používejte pouze součástky dodané výrobcem.

5.  
Nepokládejte nábytek do blízkosti otevřeného ohně nebo k jiným zdrojům tepla, jako je elektrické nebo plynové topení apod., mohlo by dojít ke vznícení.

**VERY IMPORTANT!  
PLEASE READ CAREFULLY  
SAVE FOR FUTURE USE  
USER'S MANUAL**

1.  
To avoid the danger of choking or strangulation keep the package with fittings away from babies and children.

2.  
All connections must be tightened properly and no coupled element can not be loose.

3.  
Do not use the bed when, if any of the elements is damaged or if there is any element missing.

4.  
Use only the elements given by manufacturer.

5.  
Do not place the bed near naked flames or other heat sources such as electric or gas radiators etc., this may cause a fire.

3

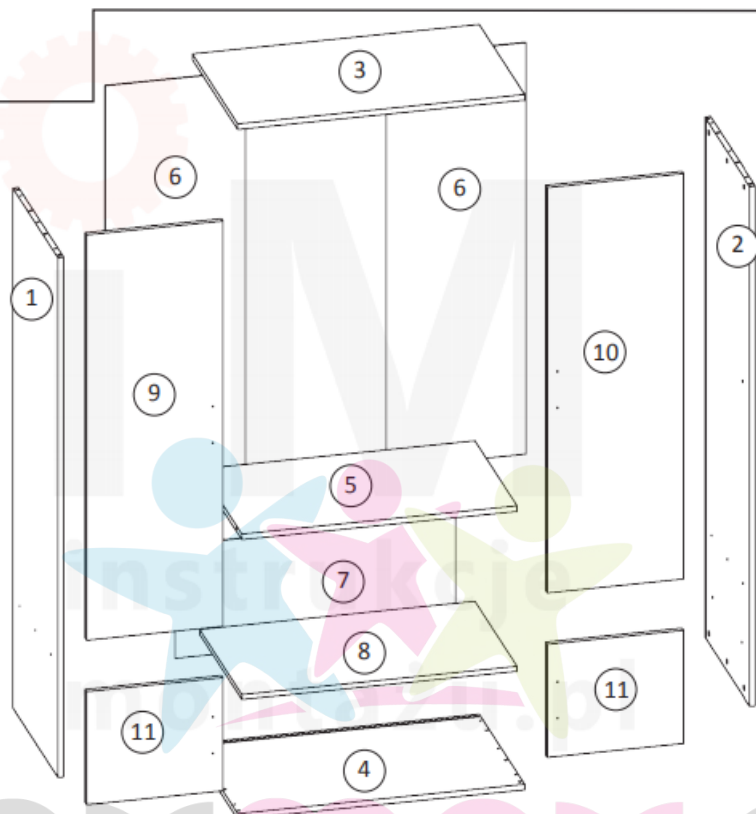

#### Balení 1 z 1 / Package 1 of 1

Číslo položky/ item no.	Rozměry(mm)/ Dimensions (mm)	Počet/ Quantity
1	1672 x 540 x 18	1
2	1672 x 540 x 18	1
3	884 x 542 x 18	1
4	884 x 542 x 18	1
5	846 x 507 x 18	1
6	1298 x 431 x 3	2
7	392 x 864 x 3	1
8	846 x 497 x 18	1
9	420 x 1290 x 18	1
10	420 x 1290 x 18	1
11	420 x 378 x 18	2

Před montáží se ujistěte, že balení obsahuje všechny položky uvedené na této stránce a zkontrolujte, jestli žádná z položek není poškozena. V případě, že některá z položek chybí nebo jeví známky poškození, kontaktujte prodejce tohoto výrobku.

-----  
 BEFORE ASSEMBLING THE FURNITURE PLEASE CHECK THAT PACKAGES INCLUDE ALL ITEMS LISTED IN THE TABLE ON PAGE NO 3, AND WHETHER THESE ITEMS ARE NOT DAMAGED !!!  
 IF MISSING PARTS OR SOME OF THEM ARE DAMAGED, PLEASE CONTACT OUR CUSTOMER SERVICE OFFICE.  
 DAMAGES FOUND AFTER ASSEMBLING WILL NOT BE CONSIDERED !!!

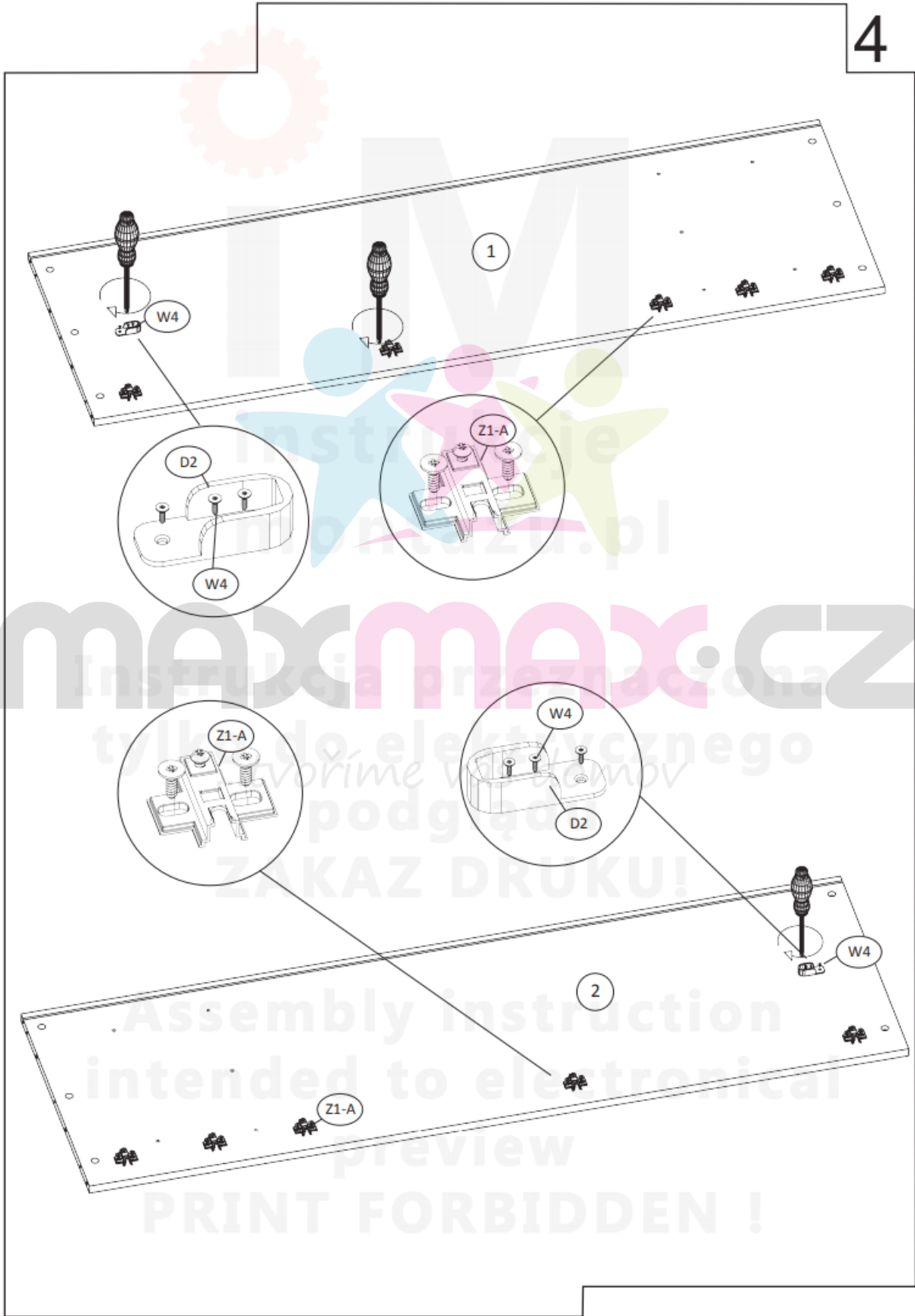

5

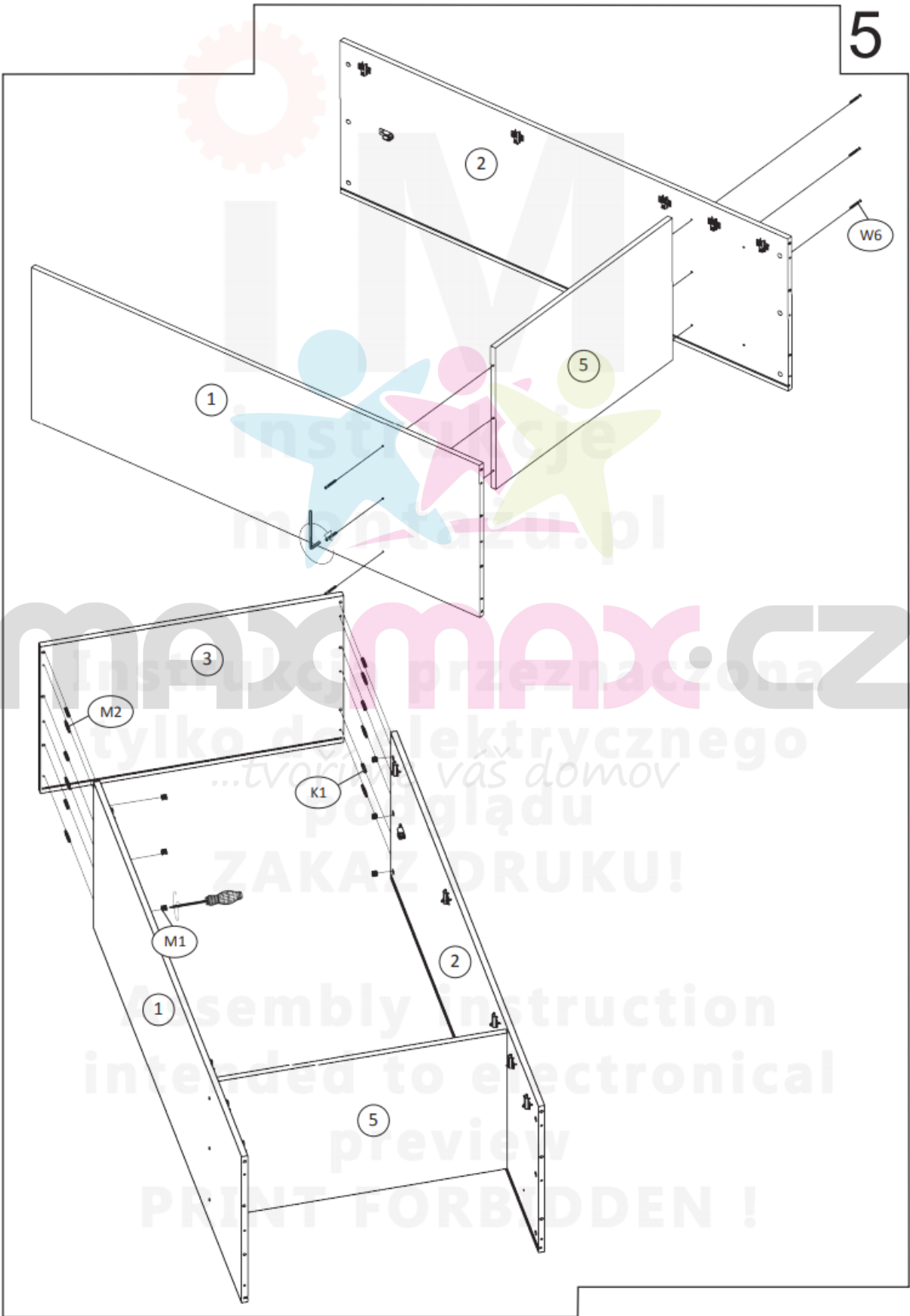

6

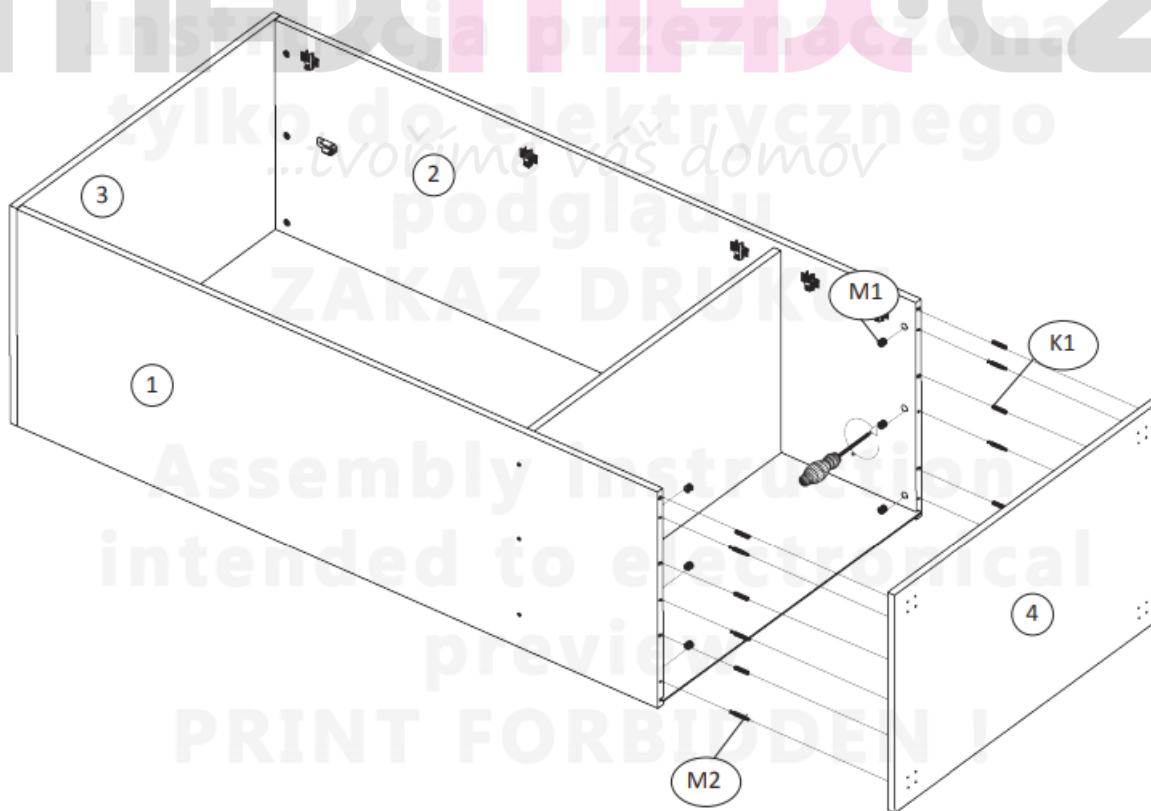
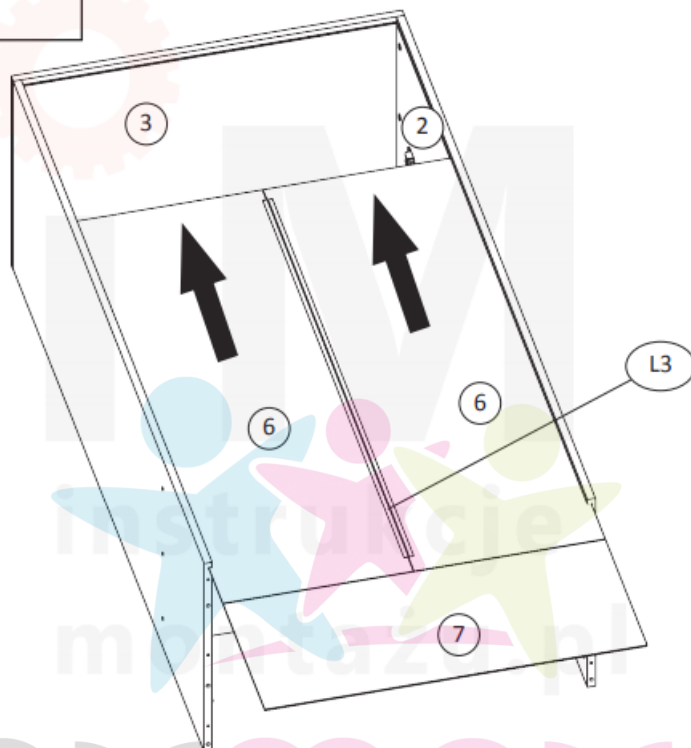

maxmax.cz

Instrukcja przeznaczona  
tylko do elektrycznego  
podglądu  
ZAKAZ Druk

Assembly instruction  
intended to electrical  
preview  
PRINT FORBIDDEN

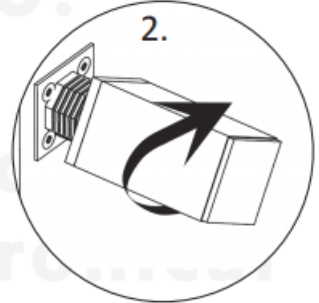
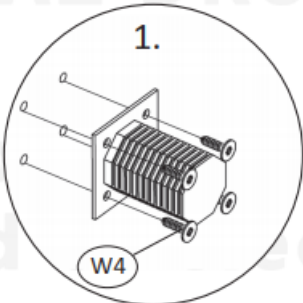
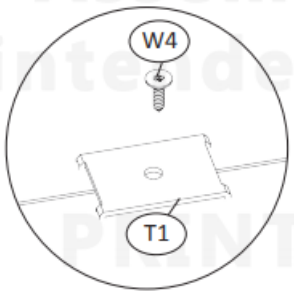
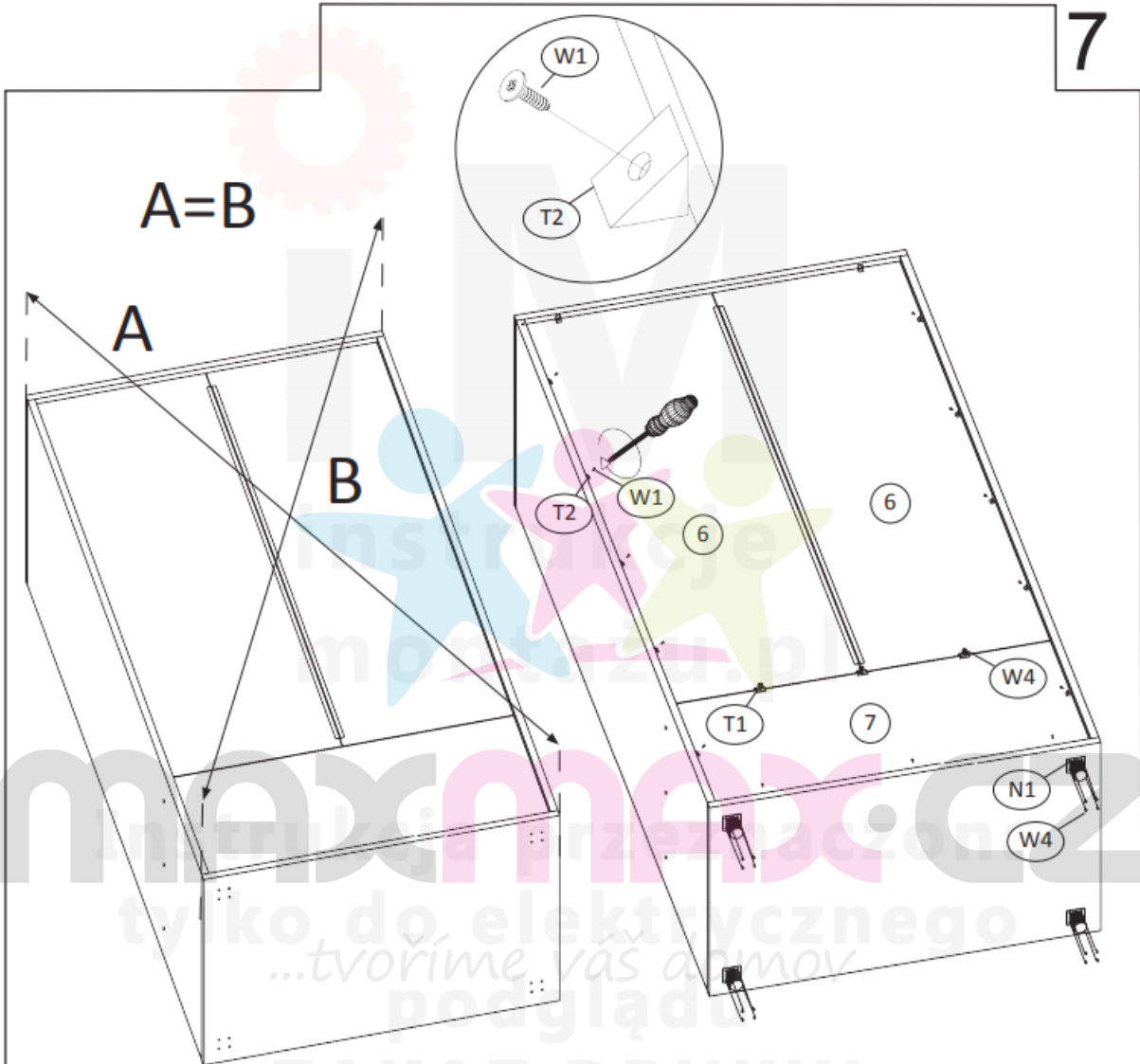

ZAKAZ DRUKU!

Assembly intended for electronic preview PRINT FORBIDDEN!

8

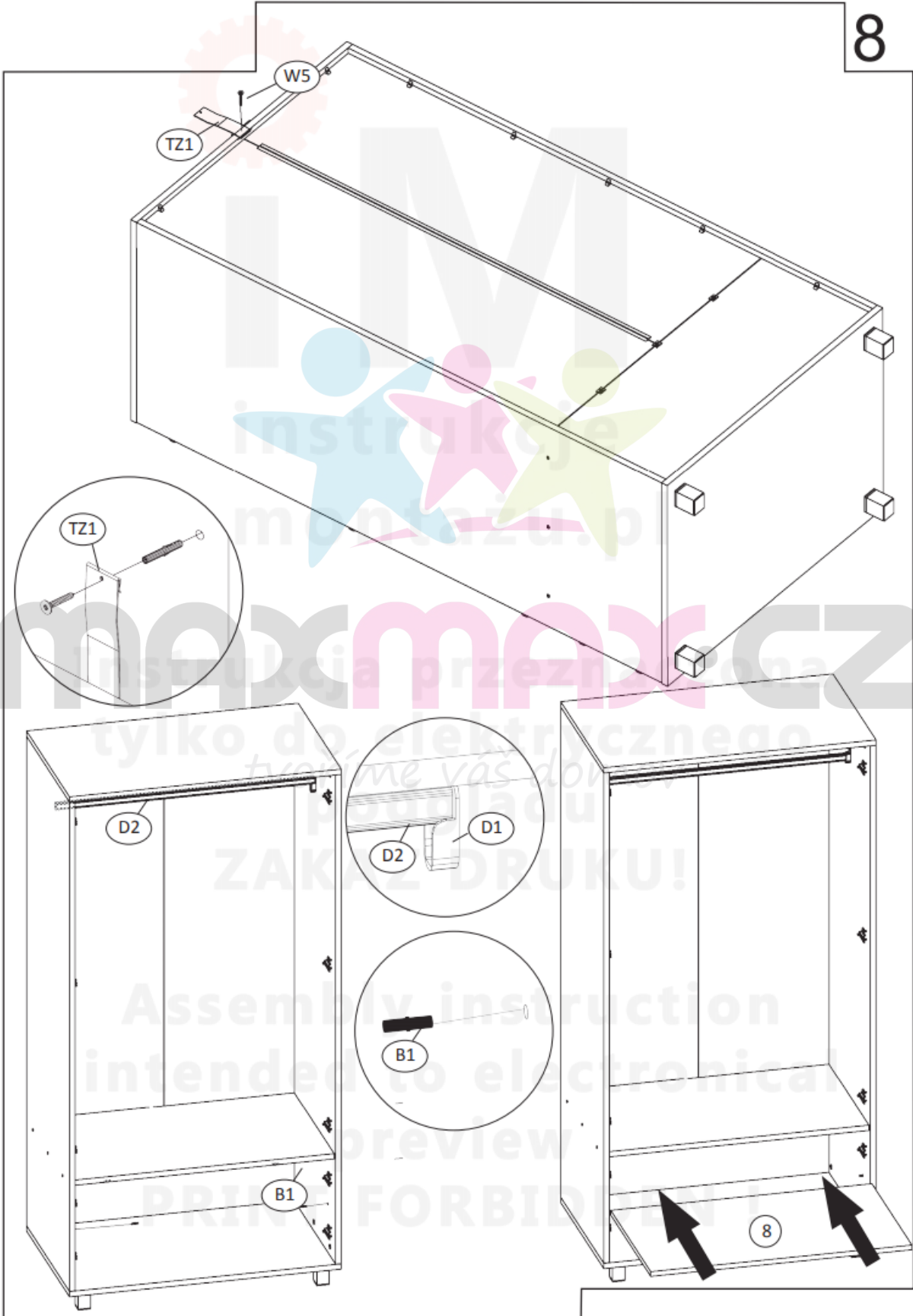



9

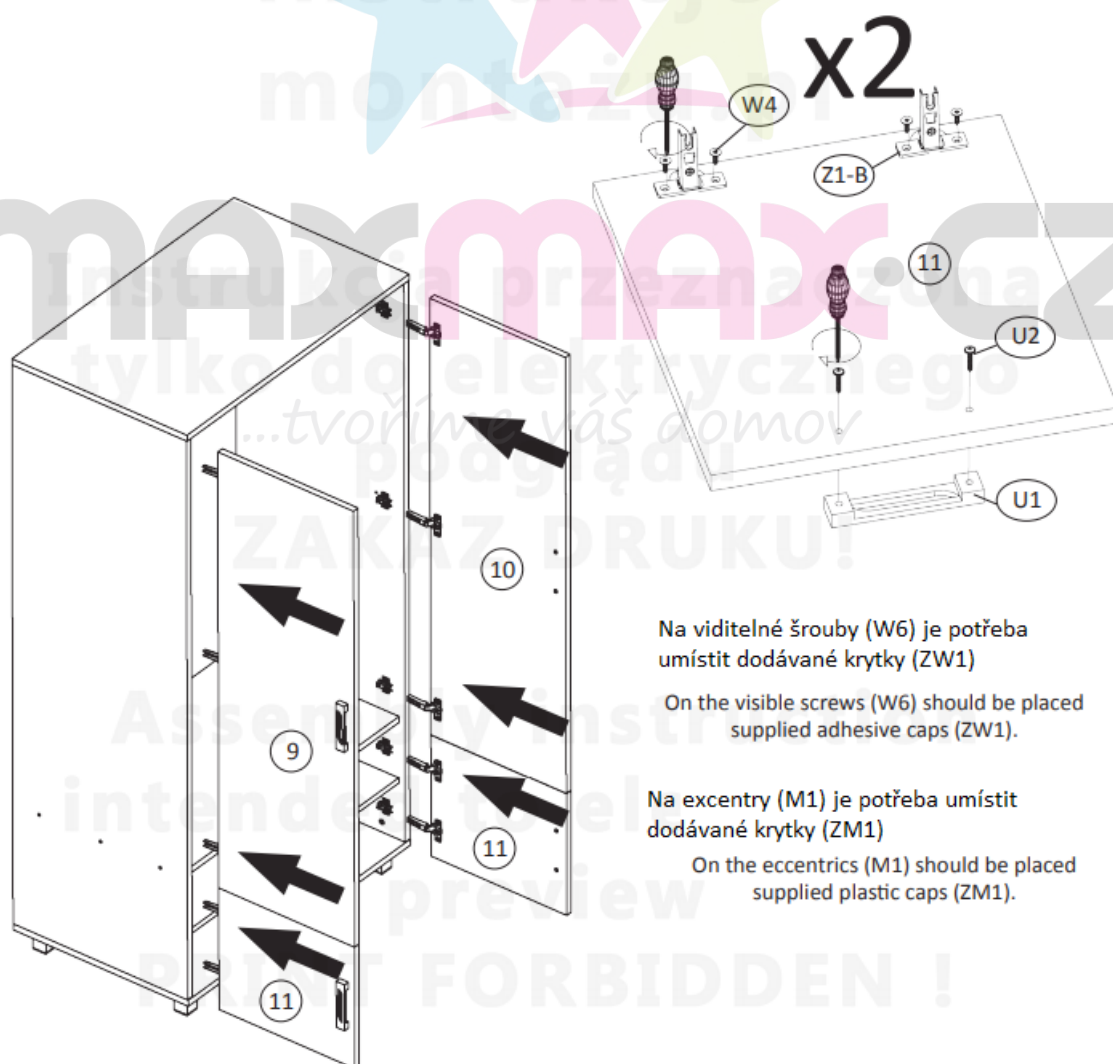
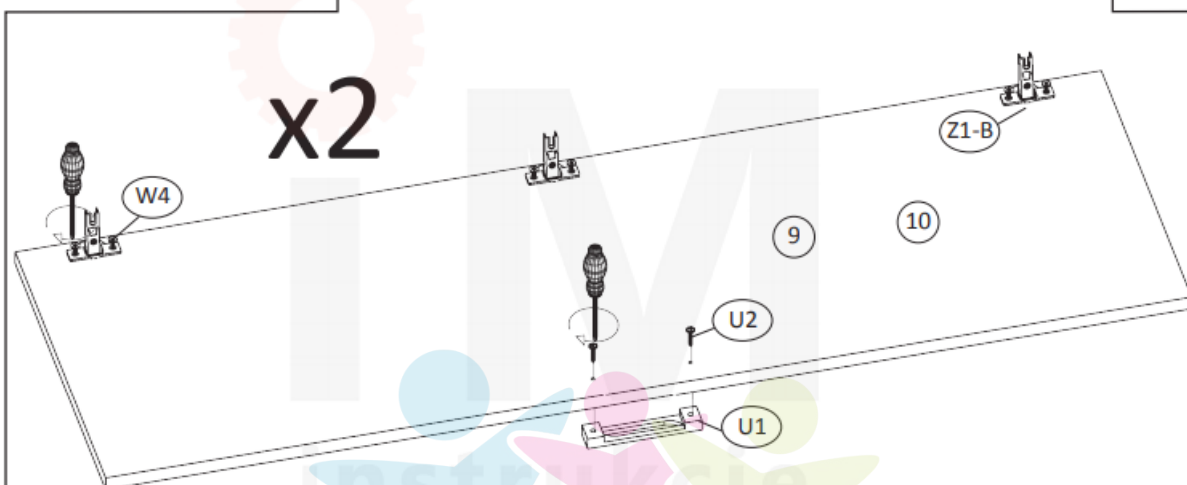

Na viditelné šrouby (W6) je potřeba  
umístit dodávané krytky (ZW1)

On the visible screws (W6) should be placed  
supplied adhesive caps (ZW1).

Na excentry (M1) je potřeba umístit  
dodávané krytky (ZM1)

On the eccentrics (M1) should be placed  
supplied plastic caps (ZM1).