















## Dětský úložný regál ANIMALS TYP 2 - NÍZKÝ RN02 (otevírání doleva)

### NÁVOD K MONTÁŽI

Příslušenství / Fittings						
K1  8 ks / pcs	M2  8 ks / pcs	M1  8 ks / pcs	ZM1  8 ks / pcs	ZW1  4 ks / pcs	T2  8 ks / pcs	B1  8 ks / pcs
Z1-A  2 ks / pcs	Z1-B  2 ks / pcs	W4  Ø4 x 16 24 ks / pcs	W6  Ø6,3 x 50 4 ks / pcs	U1  1 ks / pcs	U2  2 ks / pcs	N1  4 ks / pcs

ZAKAZ DRUKU!  
...tvoríme váš domov

Nástroje / Tools		
		

MONTÁŽ REGÁLU JE MOŽNÁ POUZE VE DVOU OSOBÁCH

**VELMI DŮLEŽITÉ!  
ČTĚTE PEČLIVĚ  
NÁVOD SI ULOŽTE PRO POZDĚJŠÍ POUŽITÍ  
UŽIVATELSKÁ PŘÍRUČKA**

1.  
Veškerý obalový materiál odstraňte mimo dosah dětí, tak aby nemohlo dojít k udušení nebo uškrcení.
2.  
Všechny spoje musí být řádně dotaženy, žádná součástka nesmí zůstat volná.
3.  
Nábytek nepoužívejte v případě, že je nějaká součástka poškozená, či chybí.
4.  
Používejte pouze součástky dodané výrobcem.
5.  
Nepokládejte nábytek do blízkosti otevřeného ohně nebo k jiným zdrojům tepla, jako je elektrické nebo plynové topení apod., mohlo by dojít ke vznícení.
6.  
Nábytek musí být připevněn ke stěně pomocí dodané pásky jako ochrana před převrácením.

**VERY IMPORTANT!  
PLEASE READ CAREFULLY  
SAVE FOR FUTURE USE**

**USER'S MANUAL**

1.  
To avoid the danger of choking or strangulation keep the package with fittings away from babies and children.
2.  
All connections must be tightened properly and no coupled element can not be loose.
3.  
Do not use the bed when, if any of the elements is damaged or if there is any element missing.
4.  
Use only the elements given by manufacturer.
5.  
Do not place the bed near naked flames or other heat sources such as electric or gas radiators etc., this may cause a fire.
6.  
Do not leave anything in the bed and do not place the crib near any equipment, where a child can prop up its foot or cause danger of strangulation or hanging of a child, e.g. wires, strings of drapers/curtains.

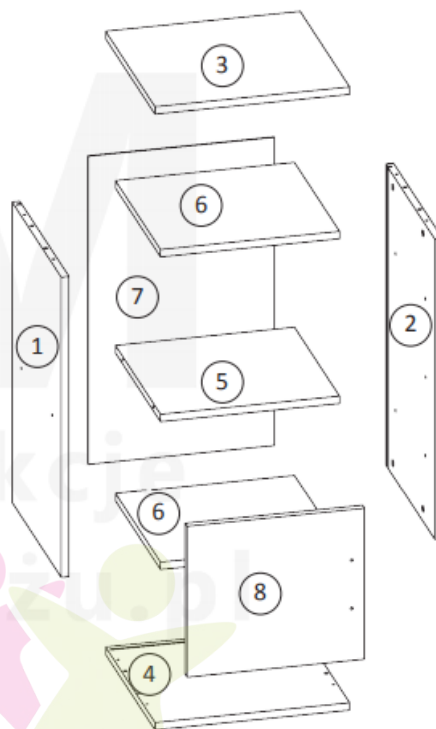

**Balení 1 z 1 / Package 1 of 1**

Číslo položky / item no.	Rozměry (mm) / Dimensions (mm)	Počet / Quantity
1	760 x 340 x 18	1
2	760 x 340 x 18	1
3	452 x 342 x 18	1
4	452 x 342 x 18	1
5	414 x 307 x 18	1
6	414 x 297 x 18	2
7	778 x 431 x 3	1
8	410 x 378 x 18	1

## Assembly instruction

Před montáží se ujistěte, že balení obsahuje všechny položky uvedené na této stránce a zkontrolujte, jestli žádná z položek není poškozena. V případě, že některá z položek chybí nebo jeví známky poškození, kontaktujte prodejce tohoto výrobku.

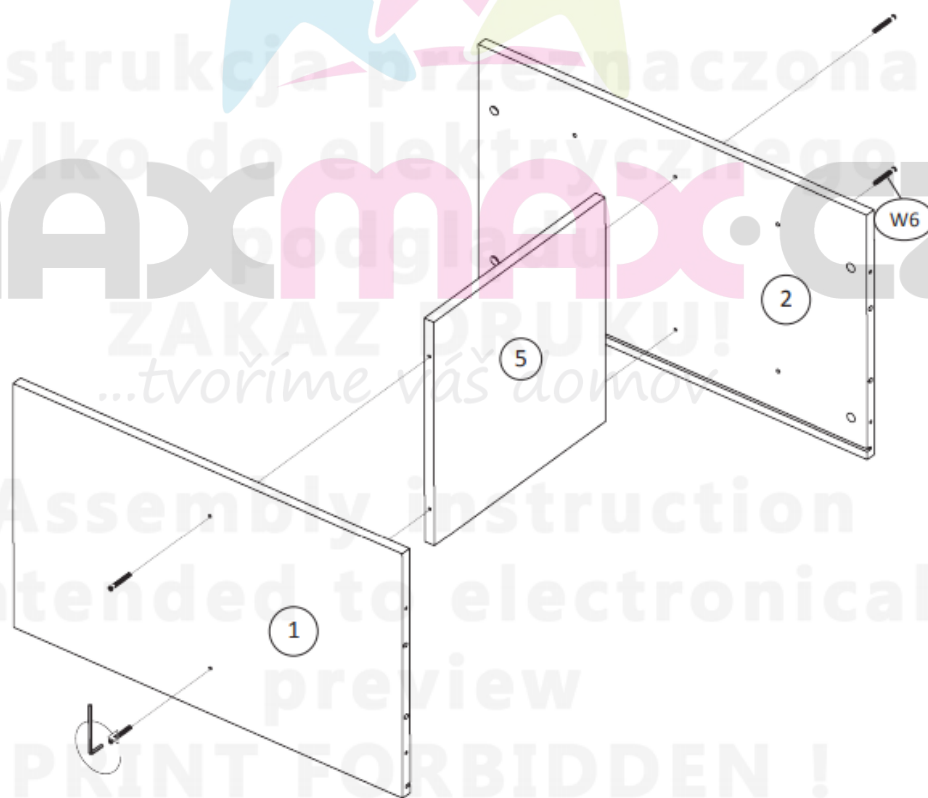
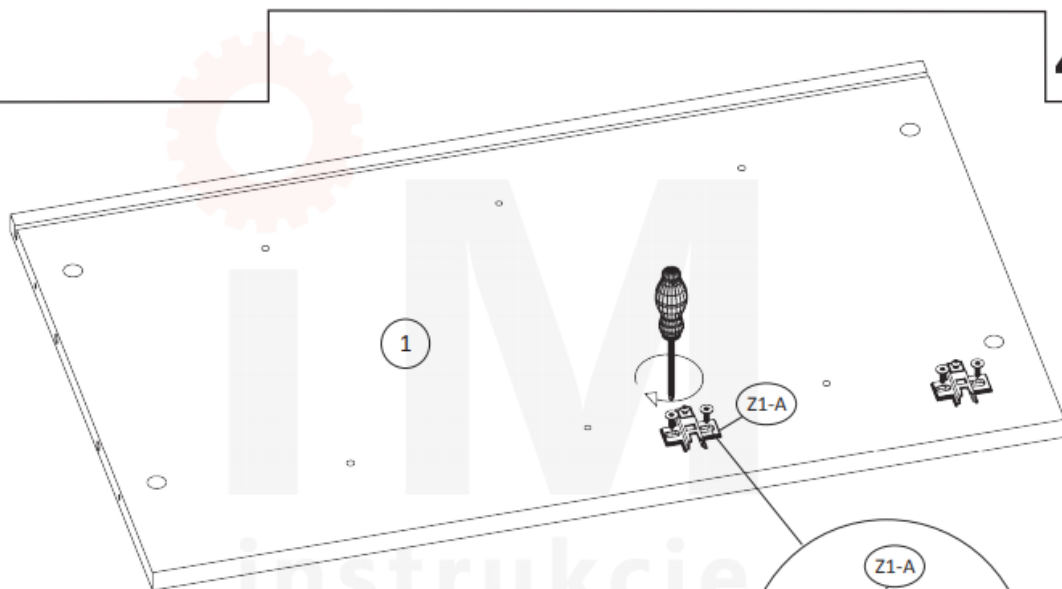
BEFORE ASSEMBLING THE FURNITURE PLEASE CHECK THAT PACKAGES INCLUDE ALL ITEMS LISTED IN THE TABLE ON PAGE NO 3, AND WHETHER THESE ITEMS ARE NOT DAMAGED !!!  
IF MISSING PARTS OR SOME OF THEM ARE DAMAGED, PLEASE CONTACT OUR CUSTOMER SERVICE OFFICE.  
DAMAGES FOUND AFTER ASSEMBLING WILL NOT BE CONSIDERED !!!



Instrukcja przeznaczona tylko do elektrycznego podglądu.  
ZAKAZ DRUKU!  
...tvoríme váš domov  
Assembly instruction intended to electrical preview  
PRINT FORBIDDEN!

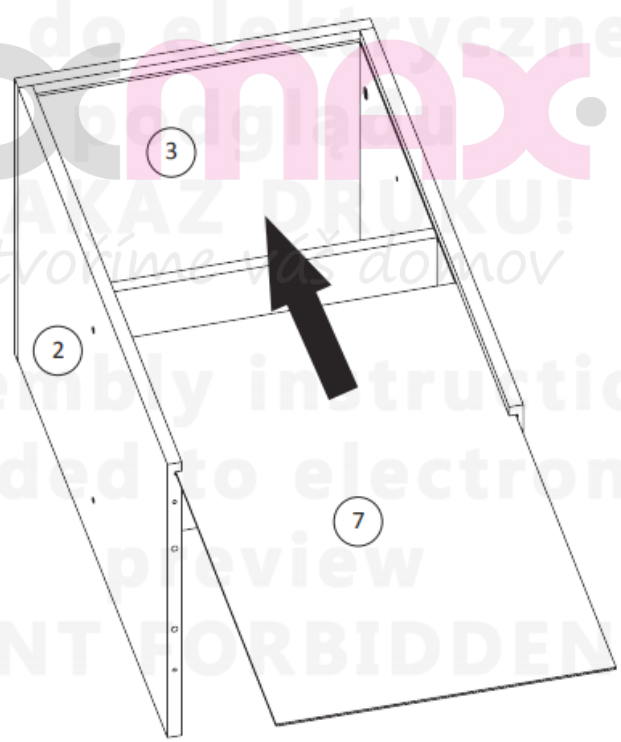
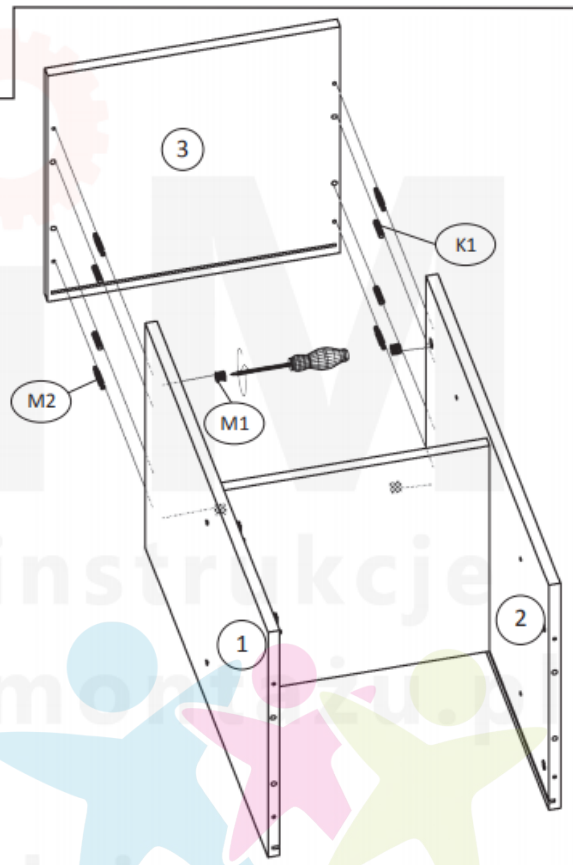

instrukcje  
monażu.  
Instrukcja przeznaczona  
tylko do elektrycznego  
MAZ max.CZ  
ZAKAZ DRUKU!  
...tvoríme váš domov  
Assembly instruction  
intended to electrical  
preview  
PRINT FORBIDDEN!

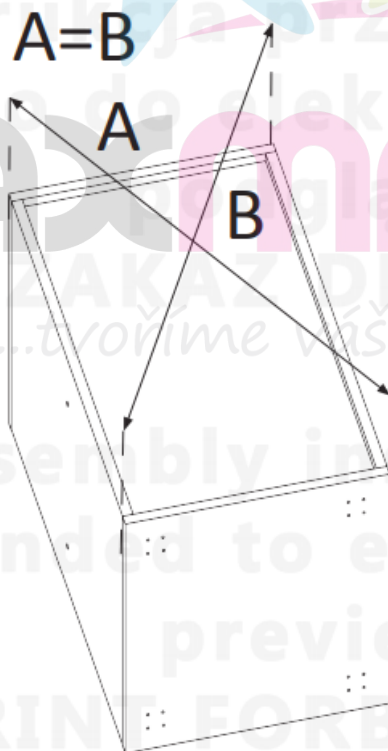
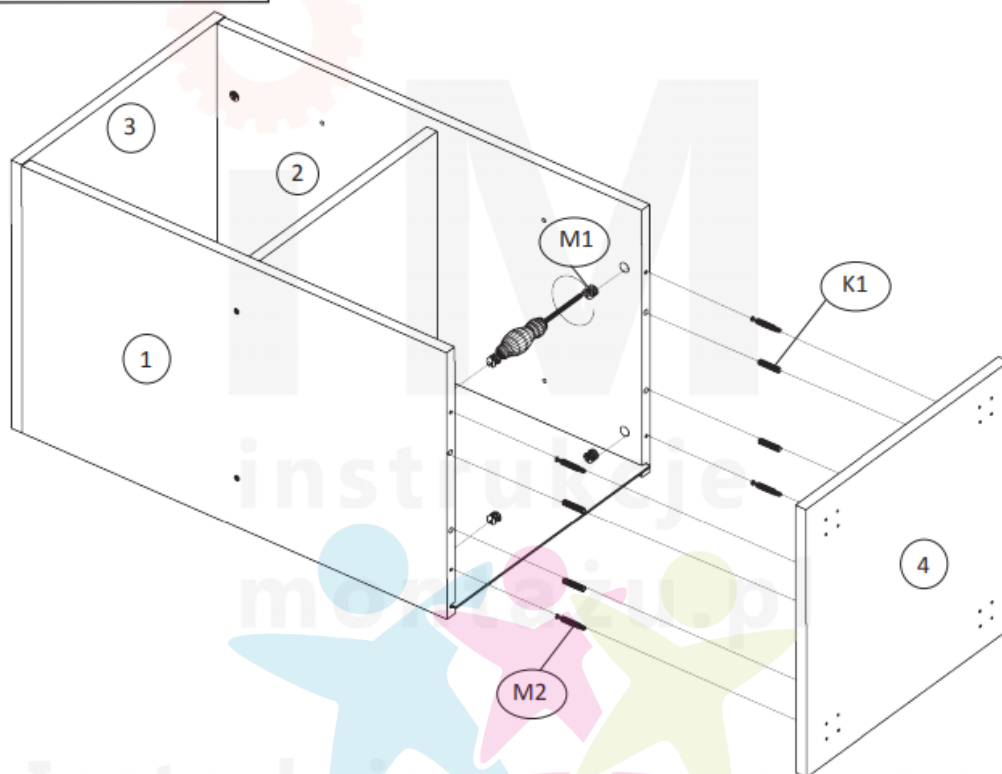

Instrukcja przeznaczona  
tylko do elektrycznego

MAX.CZ

ZAKAZ DRUKU!

...tróime váš domov

Assembly instruction  
intended to electrical  
preview

PRINT FORBIDDEN !

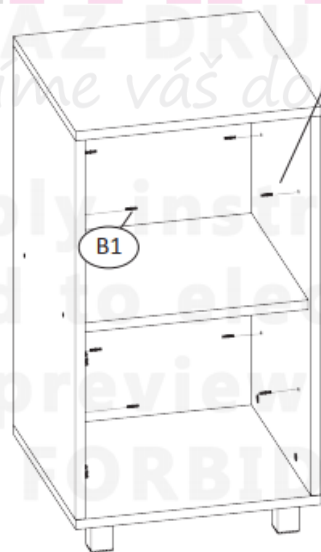
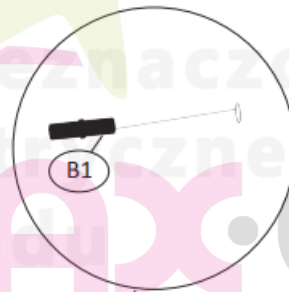
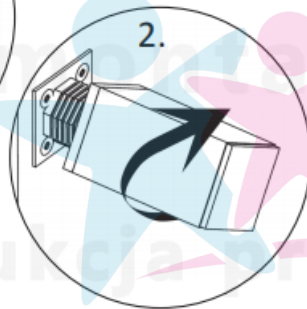
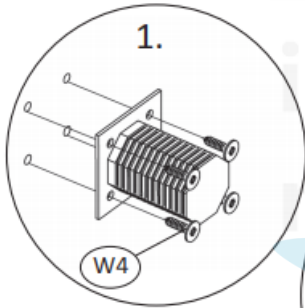
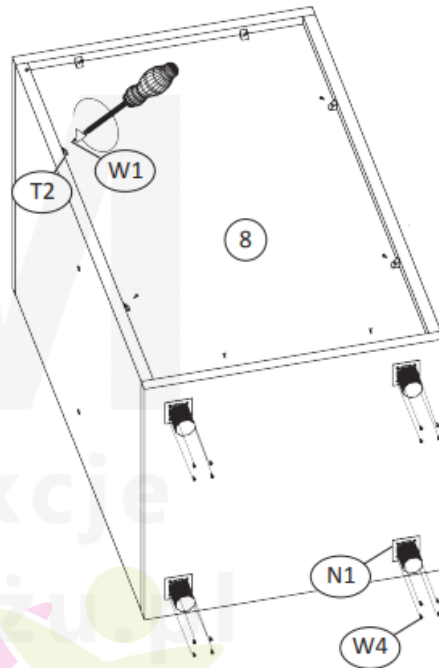
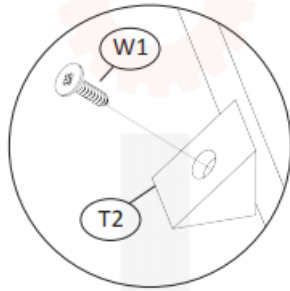

Instrukcja przeznaczona tylko do elektronicznego podglądu!  
ZAKAZ DRUKU!  
...tvoríme váš domov  
Assembly instruction intended to be an electronic preview  
PRINT FORBIDDEN!

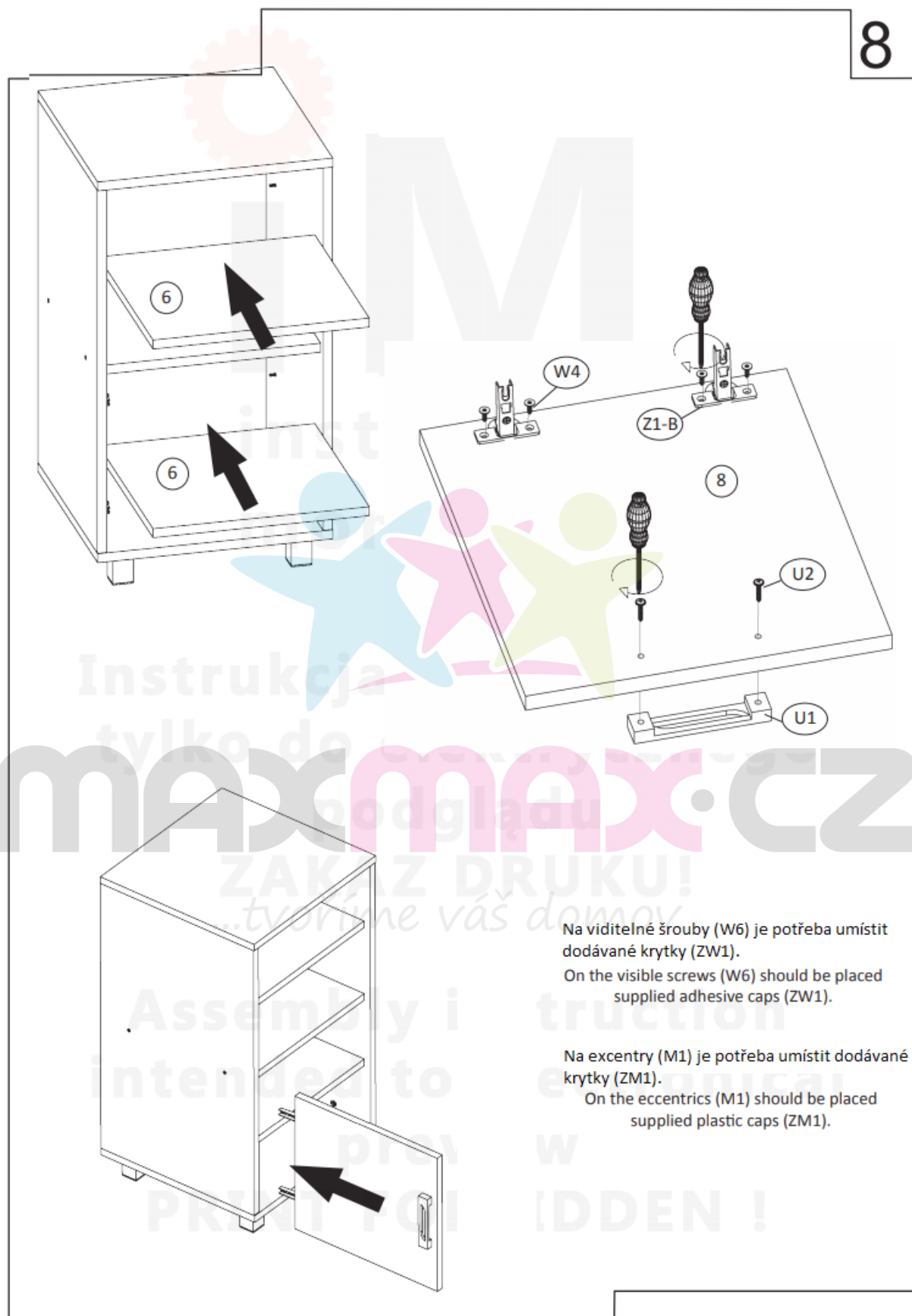

Na viditelné šrouby (W6) je potřeba umístit dodávané krytky (ZW1).

On the visible screws (W6) should be placed supplied adhesive caps (ZW1).

Na excentry (M1) je potřeba umístit dodávané krytky (ZM1).

On the eccentrics (M1) should be placed supplied plastic caps (ZM1).