













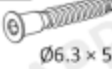
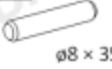







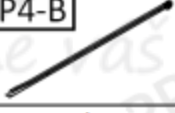

HAPPY K05

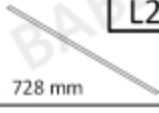
Montážní návod

Příslušenství

W1  Ø3 × 16 12 ks	W2  Ø3 × 20 10 ks	W3  Ø3,5 × 16 30 ks	W4  Ø4 × 16 4 ks	W5  Ø4 × 35 3 ks	W6  Ø6.3 × 50 20 ks	K1  Ø8 × 35 10 ks	
M1  12 ks	M2  12 ks	T2  10 ks	U1  6 ks	U2  Ø4 × 30 6 ks	S1  4 ks	TZ1  1 ks	
P3-A  3 ks	P3-B  3 ks	P4-A  3 ks	P4-B  3 ks	ZM1  12 ks	ZW1  20 ks	L2  728 mm 1 ks	
N1  2 ks	N2  2 ks	G1  46 ks					

Nářadí

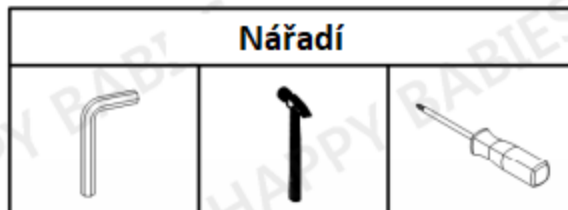

K montáži je zapotřebí přítomnost dvou osob.

VELMI DŮLEŽITÉ!
ČTĚTE POZORNĚ.
UCHOVEJTE PRO DALŠÍ POUŽITÍ.



UŽIVATELSKÁ PŘÍRUČKA

1.

Balení obsahuje malé části, proto jej udržujte mimo dosah dětí.

2.

Všechny spoje musí být řádně utaženy a žádná párová součástka nesmí být ztracena.

3.

Pokud je některá ze součástí poškozena nebo chybí, komodu nepoužívejte.

4.

Používejte pouze součástky dodány výrobcem.

5.

Neumisťujte komodu poblíž otevřenému ohni nebo dalším zdrojům tepla jakými jsou elektrické nebo plynové radiátory atd. Mohl by být způsoben požár.

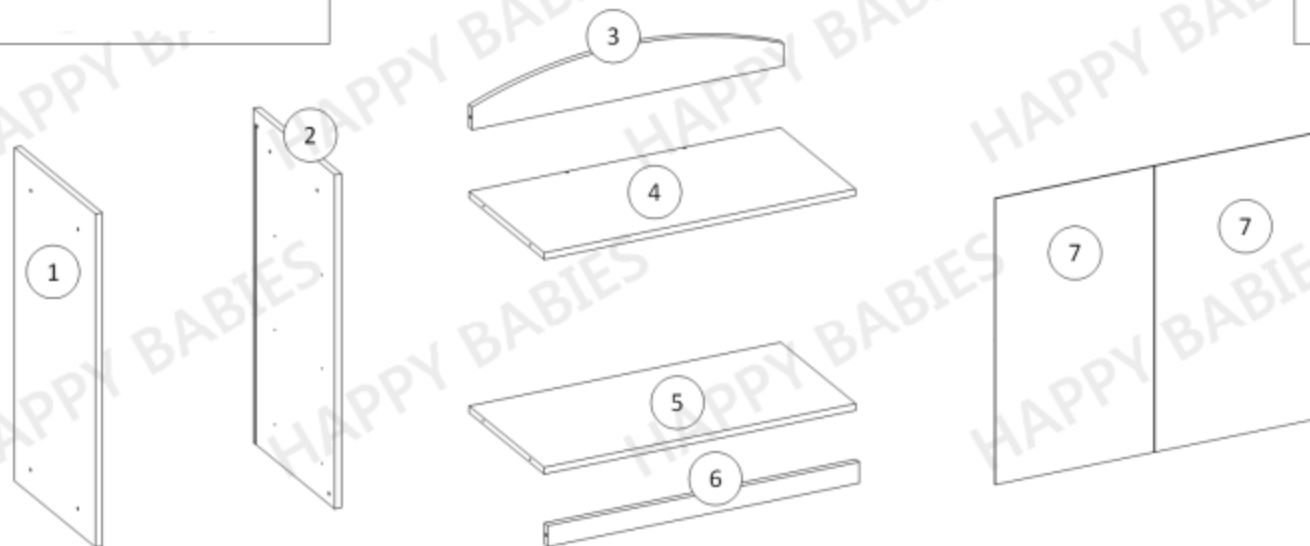

Balení 1/2		
Součástka číslo:	Rozměry (mm):	Množství:
1	890 x 440 x 18	1
2	890 x 440 x 18	1
3	846 x 140 x 18	1
6	846 x 56 x 18	1
7	431 x 764 x 3	2
9	400 x 202 x 18	2
10	785 x 184 x 18	3
11	842 x 252 x 18	3
12	803 x 404 x 3	3

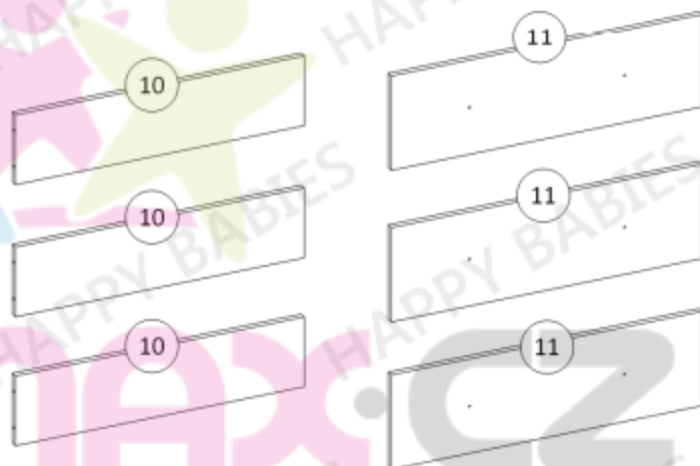

Balení 2/2		
Součástka číslo:	Rozměry (mm):	Množství:
4	846 x 407 x 18	1
5	846 x 407 x 18	1
8	400 x 202 x 18	1
9	400 x 202 x 18	3

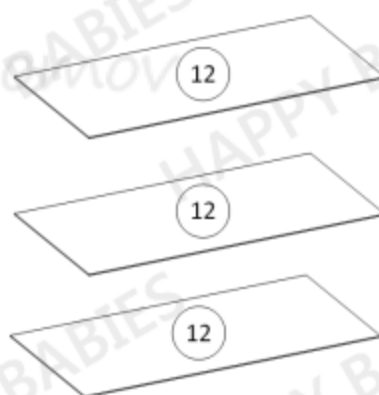

Před tím, než začnete nábytek sestavovat, zkontrolujte, že balení obsahuje všechny součástky ze seznamu na této straně (strana 3). Dále zkontrolujte, že žádná z těchto součástí není poškozena. Pokud některá ze součástí chybí nebo je poškozena, kontaktujte nás. Na škody způsobené po sestavení nebude brán ohled.

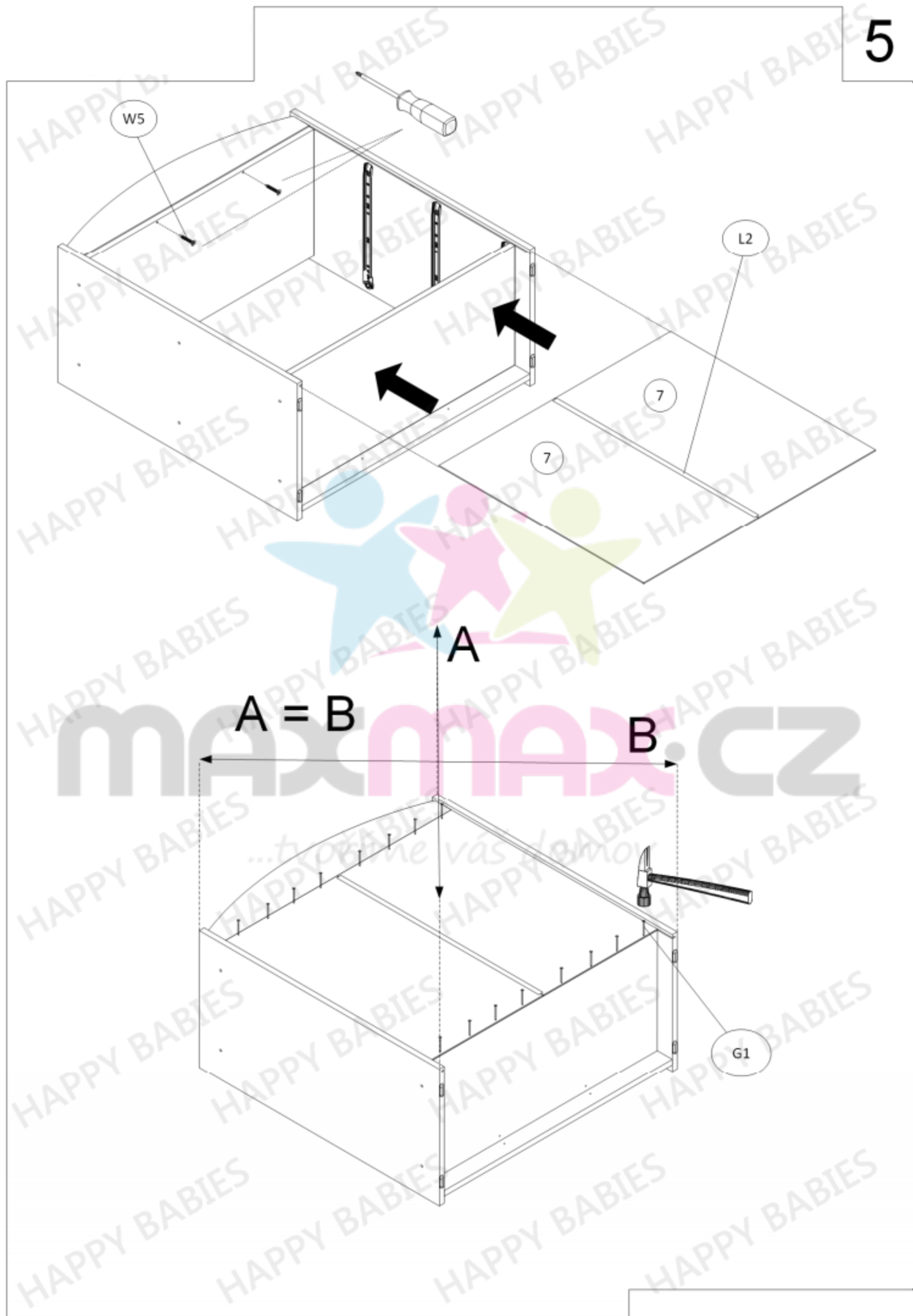

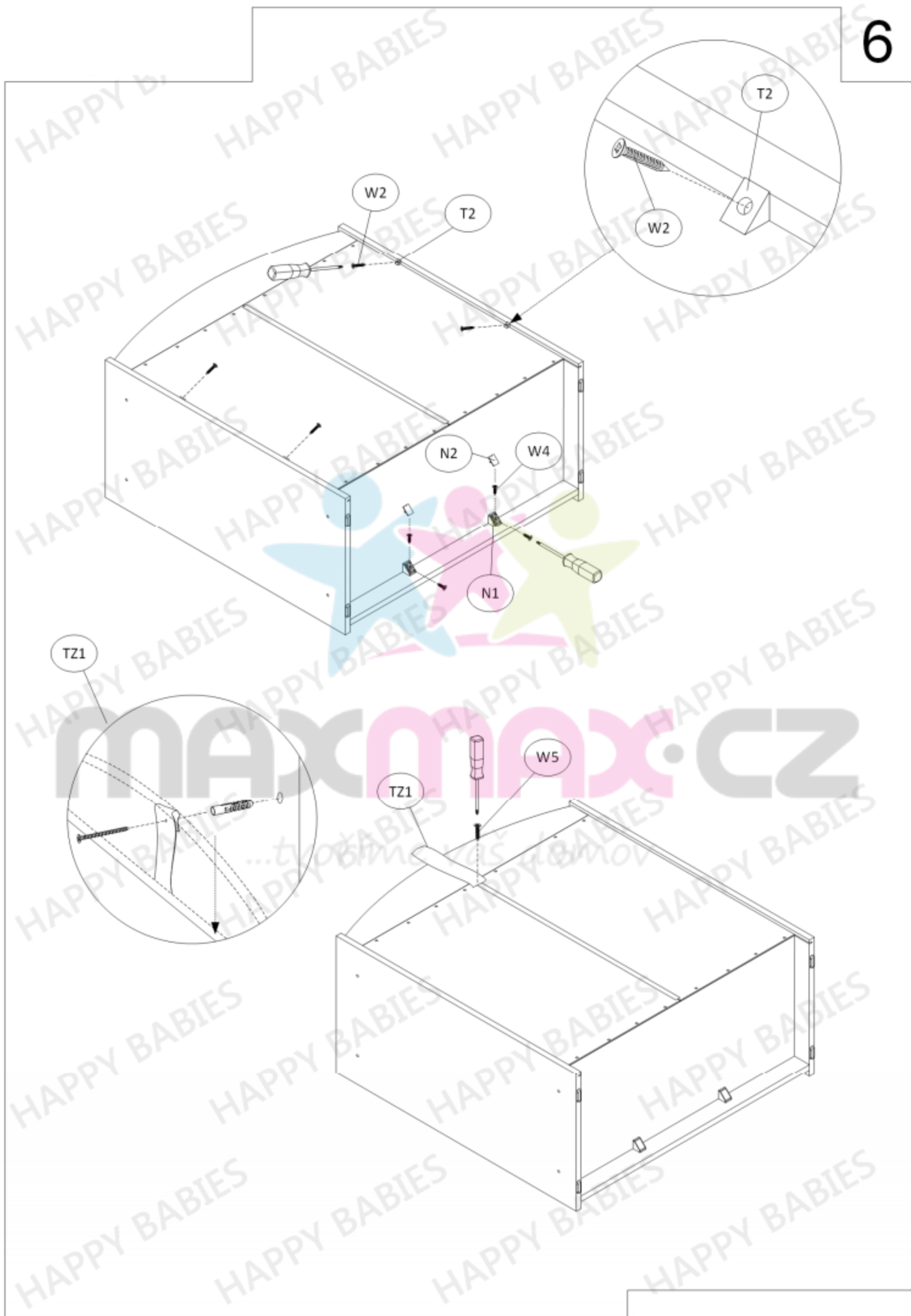

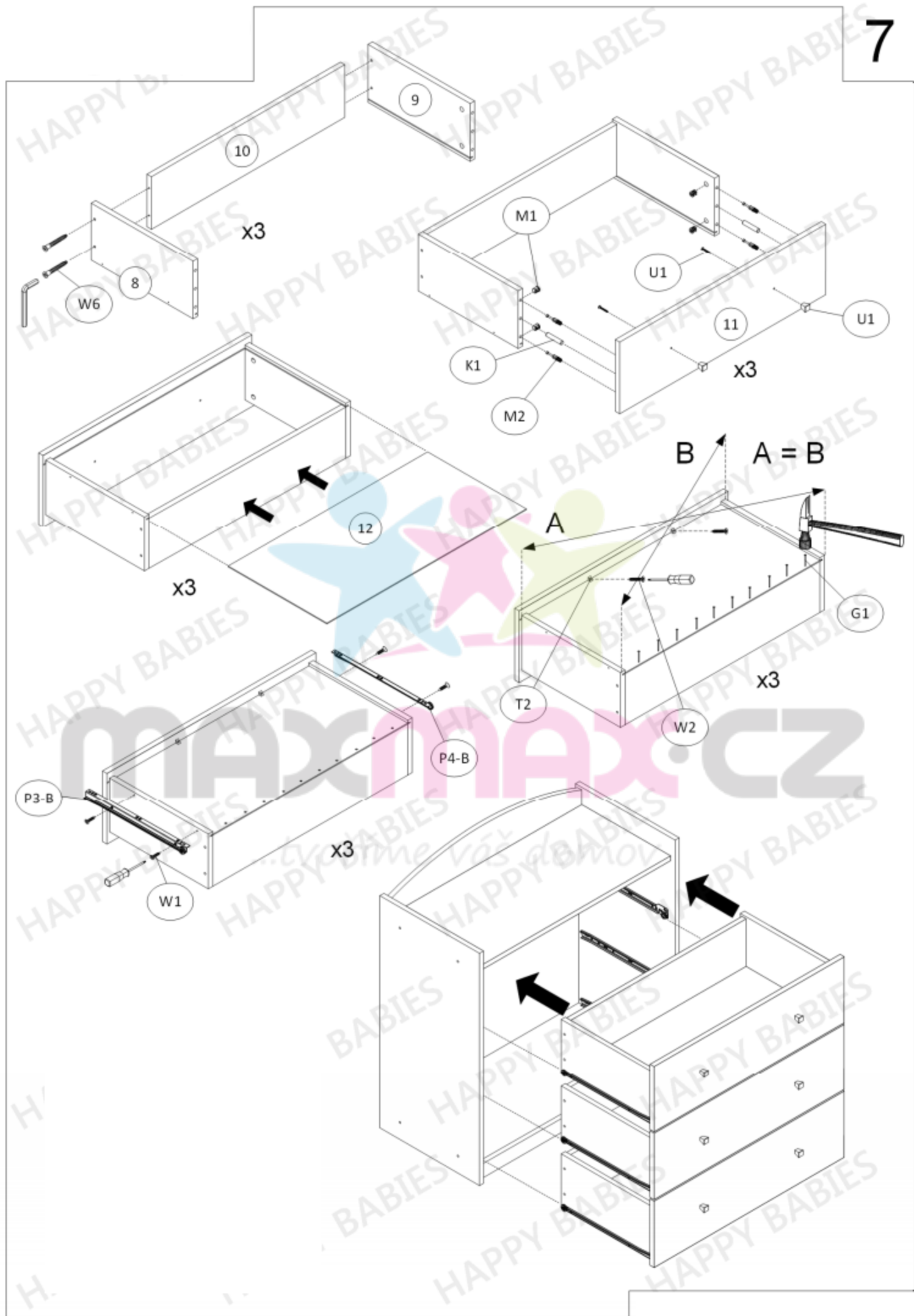

Seřízení výsuvných lišt

1. Uvolněte šrouby.

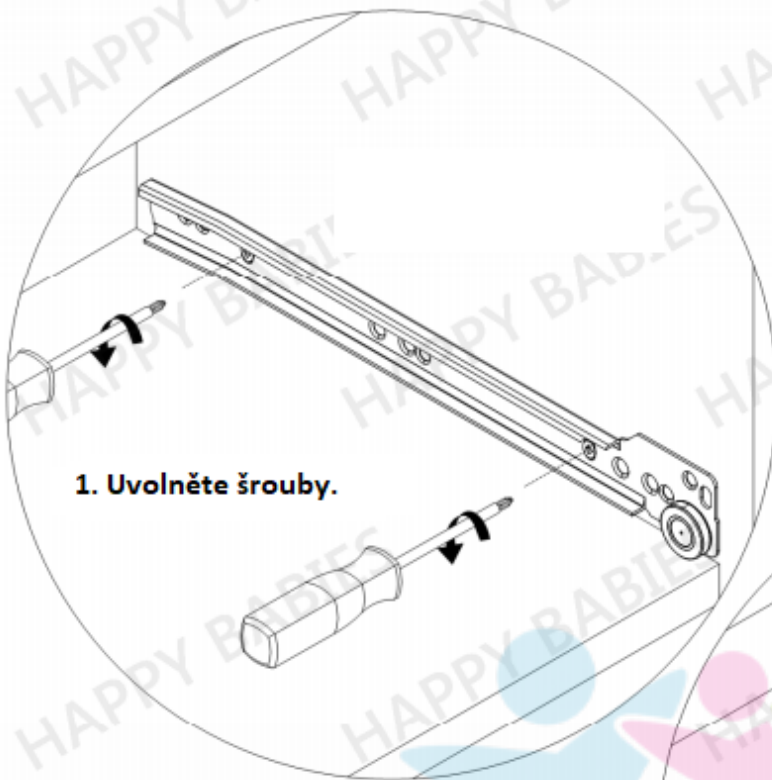

2. Posuňte lištu nahoru nebo dolů na požadovanou vzdálenost.

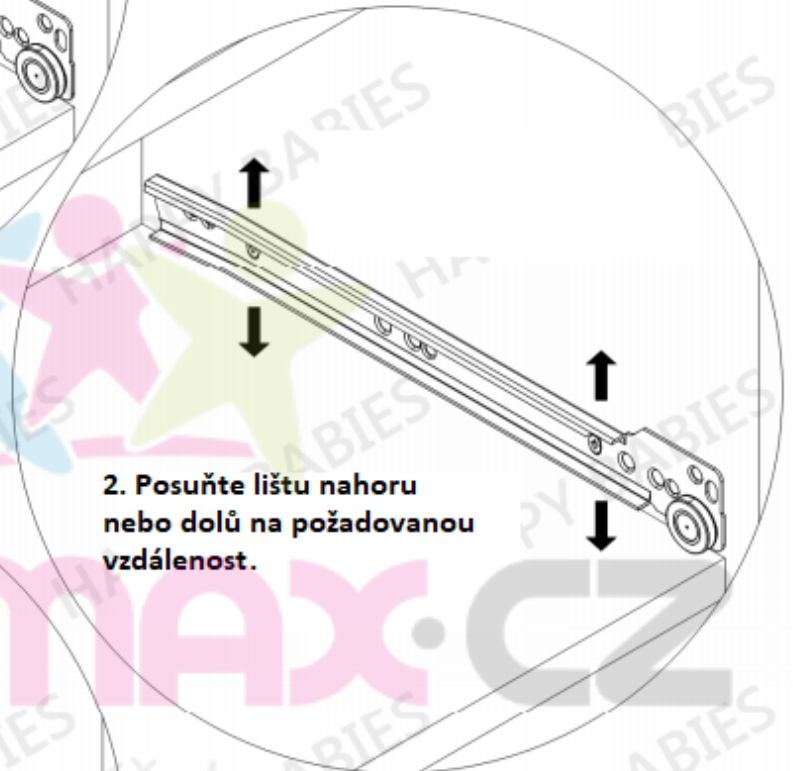

3. Utáhněte dříve uvolněné šrouby.

4. Posuňte zásuvku a zkontrolujte jestli jsou výsuvné lišty ve správné poloze.

5. Utáhněte zbylé šrouby.

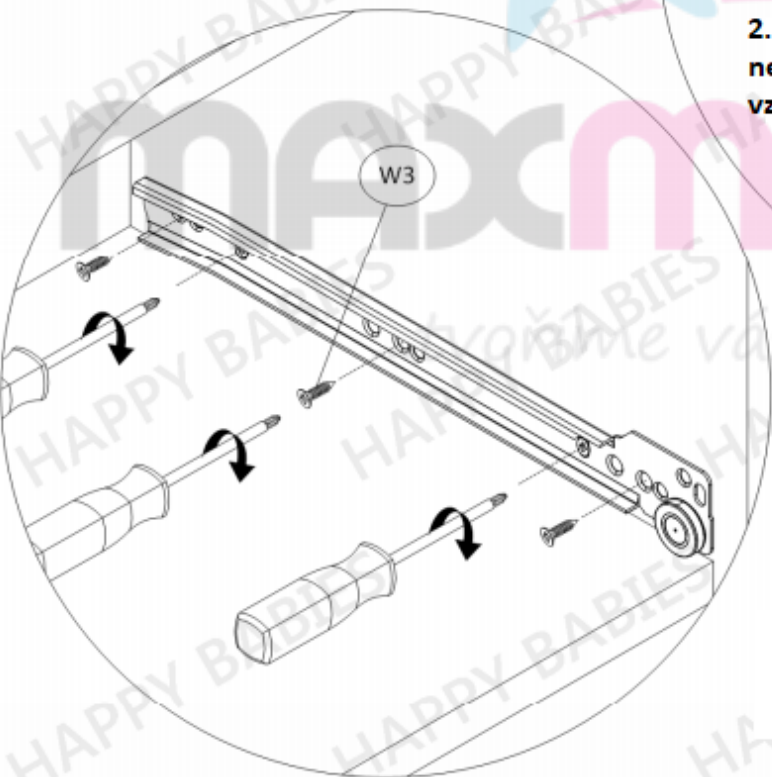

Pokud to bude nezbytné, kroky zopakujte.