

























HAPPY RN10

Montážní návod

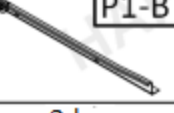

Příslušenství

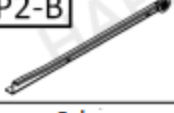
W1  Ø3 x 16 8 ks	W2  Ø3 x 20 8 ks	W3  Ø3,5 x 16 20 ks	W4  Ø4 x 16 13 ks	W5  Ø4 x 35 3 ks	W6  Ø6.3 x 50 22 ks	G1  36 ks
M1  10 ks	M2  10 ks	T1  9 ks	T2  8 ks	N1  2 ks	N2  2 ks	K1  Ø8 x 35 10 ks
U1  4 ks	U2  Ø4 x 30 4 ks	TZ1  1 ks	S1  4 ks	ZM1  10 ks	ZW1  22 ks	B1  8 ks
P1-A  2 ks	P1-B  2 ks	P2-A  2 ks	P2-B  2 ks			

Nářadí



K montáži je zapotřebí přítomnost dvou osob.

VELMI DŮLEŽITÉ!
PROSÍM, ČTĚTE POZORNĚ.
UCHOVEJTE PRO DALŠÍ POUŽITÍ.



1.

Balení obsahuje malé části, a proto jej udržujte mimo dosah dětí.

2.

Všechny spoje musí být řádně utaženy a žádná párová součástka nesmí být ztracena.

3.

Pokud je některá ze součástí poškozena nebo chybí, regál nepoužívejte.

4.

Používejte pouze součástky dodány výrobcem.

5.

Neumisťujte regál poblíž otevřenému ohni nebo dalším zdrojům tepla jakými jsou elektrické nebo plynové radiátory atd. Mohl by být způsoben požár.

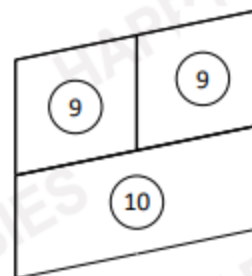
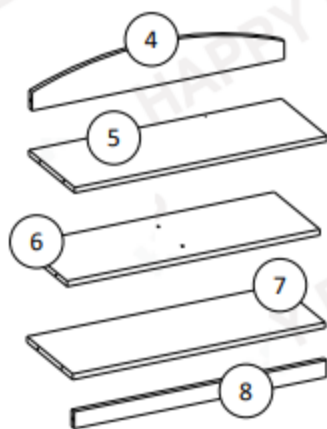
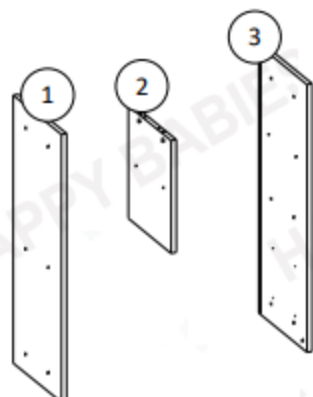

Balení 1/1		
Součástka číslo:	Rozměry (mm):	Množství:
1	890 x 340 x 18	1
2	364 x 307 x 18	1
3	890 x 340 x 18	1
4	846 x 140 x 18	1
5	846 x 307 x 18	1
6	846 x 307 x 18	1
7	846 x 307 x 18	1
8	846 x 56 x 18	1
9	431 x 390 x 3	2
10	864 x 372 x 3	1
11	414 x 297 x 18	2
12	300 x 138 x 18	2
13	300 x 138 x 18	2
14	785 x 120 x 18	2
15	842 x 188 x 18	2
16	803 x 304 x 3	2

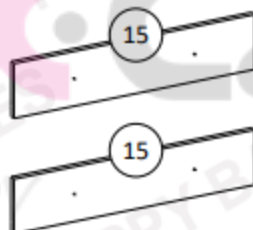

Před tím, než začnete nábytek sestavovat, zkontrolujte, že balení obsahuje všechny součástky ze seznamu na této straně (strana 3). Dále zkontrolujte, že žádná z těchto součástek není poškozena.

Pokud některá ze součástek chybí nebo je poškozena, kontaktujte nás. Na škody způsobené po sestavení nebude brán ohled.

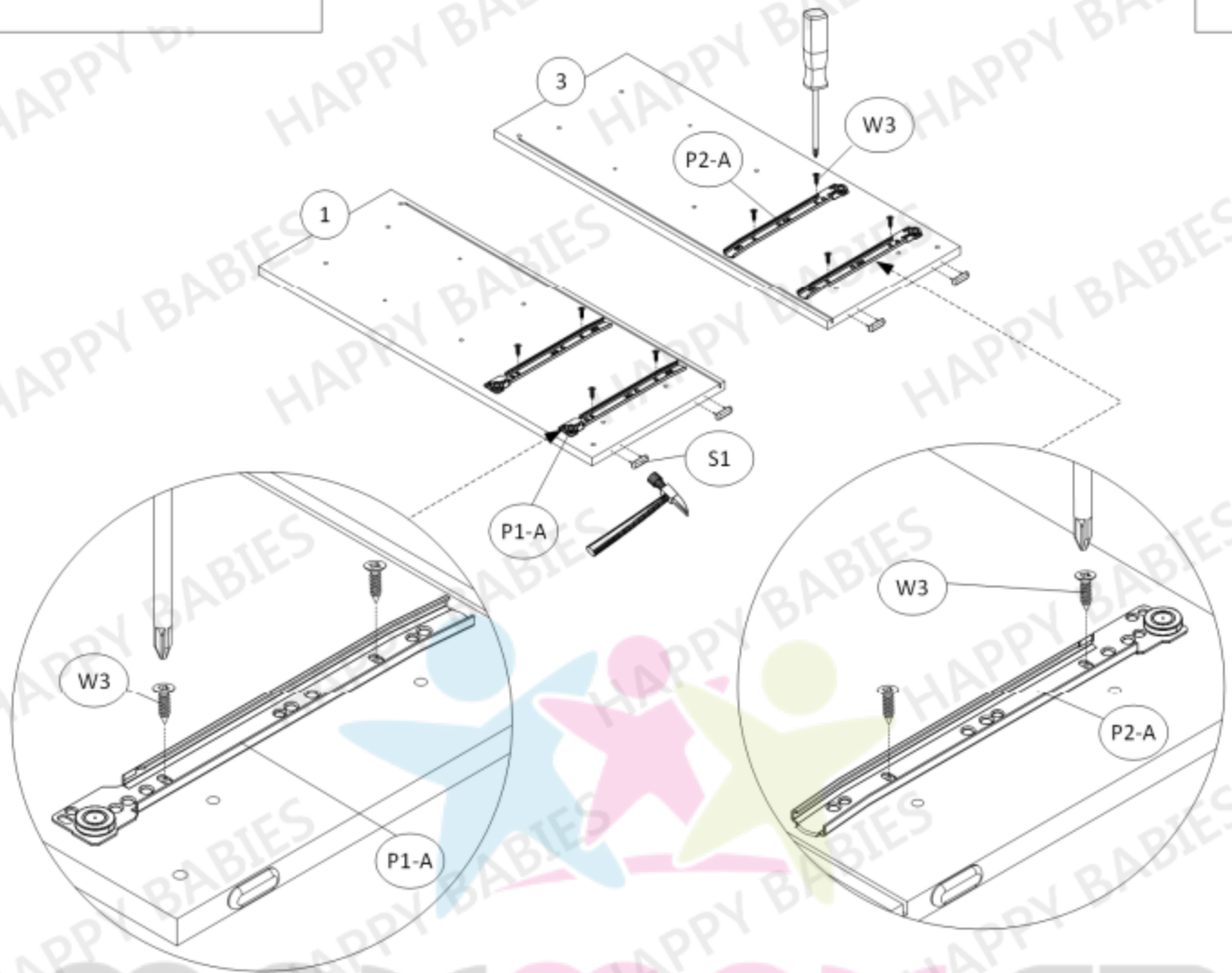

MAXmax.CZ

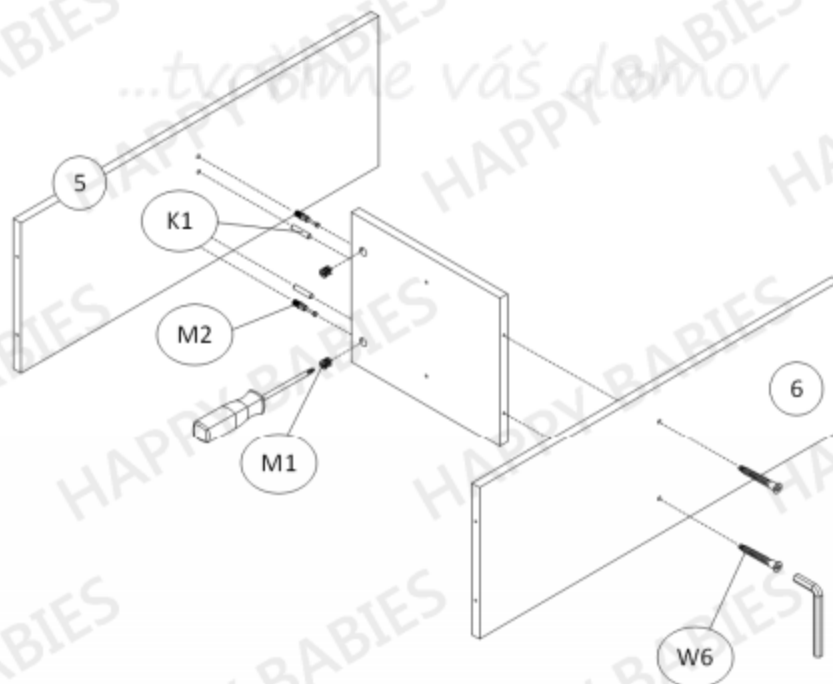

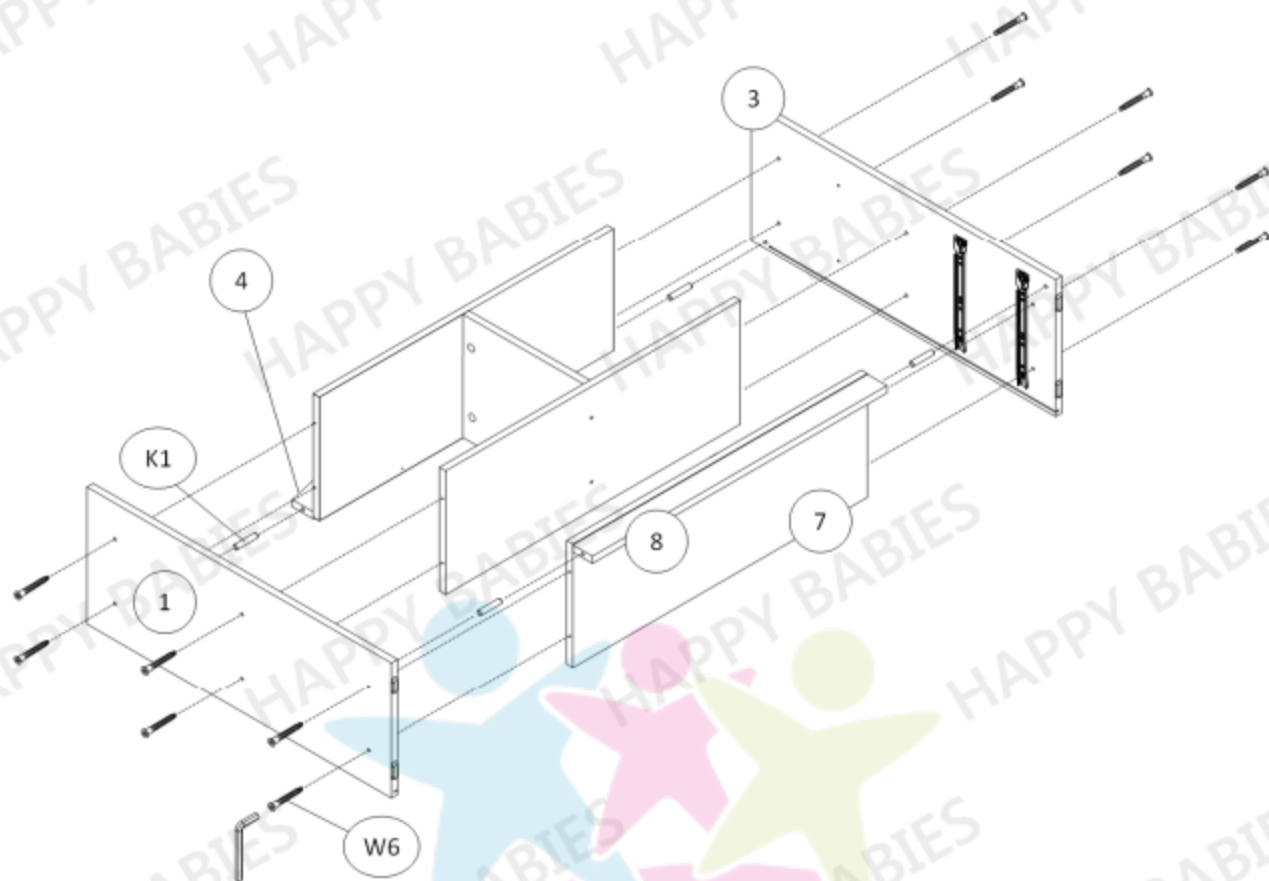

maxmax.cz

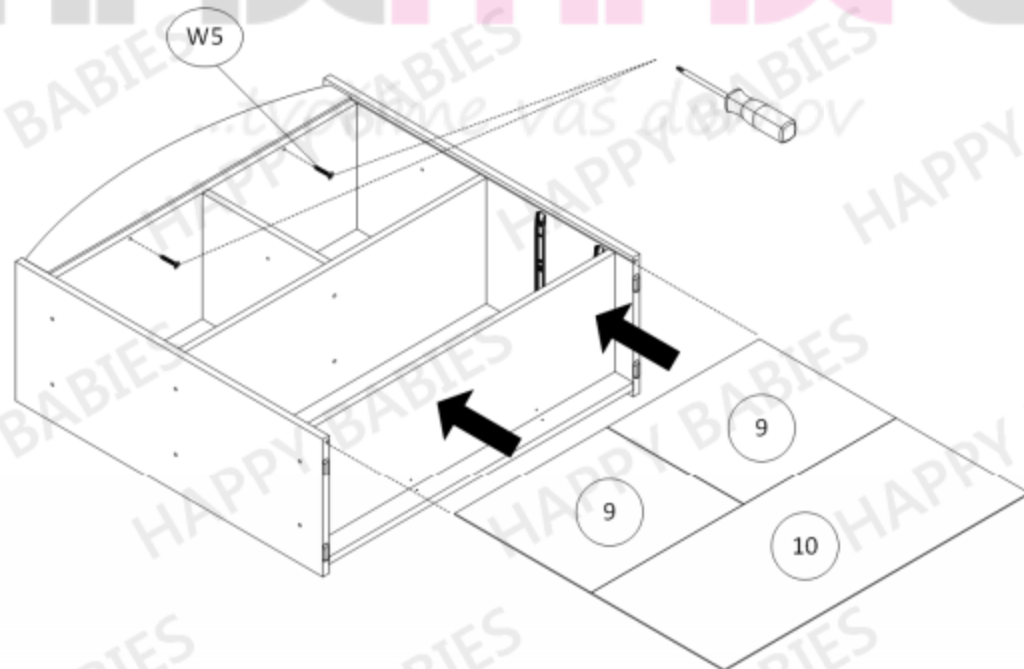

A
B
 $A = B$

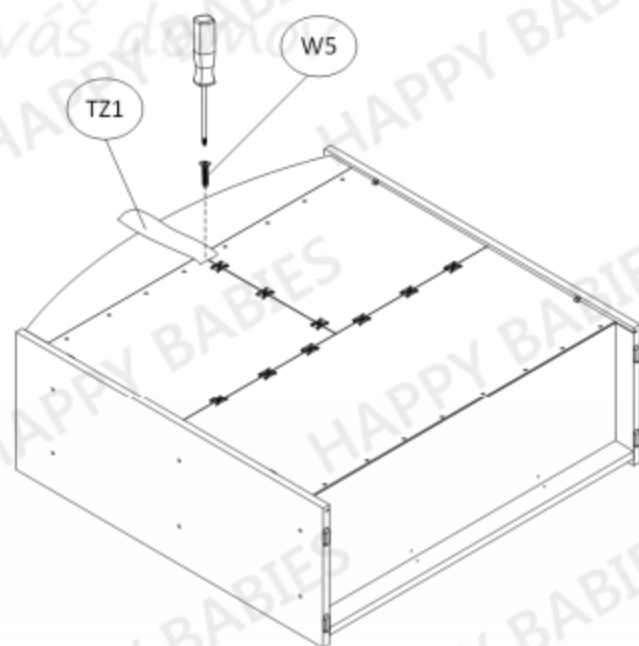
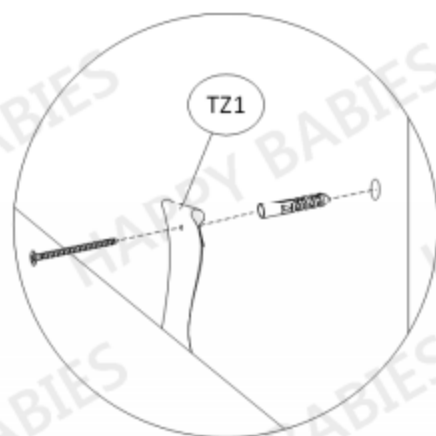
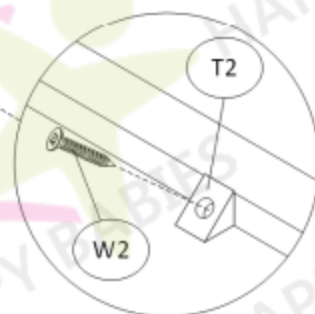
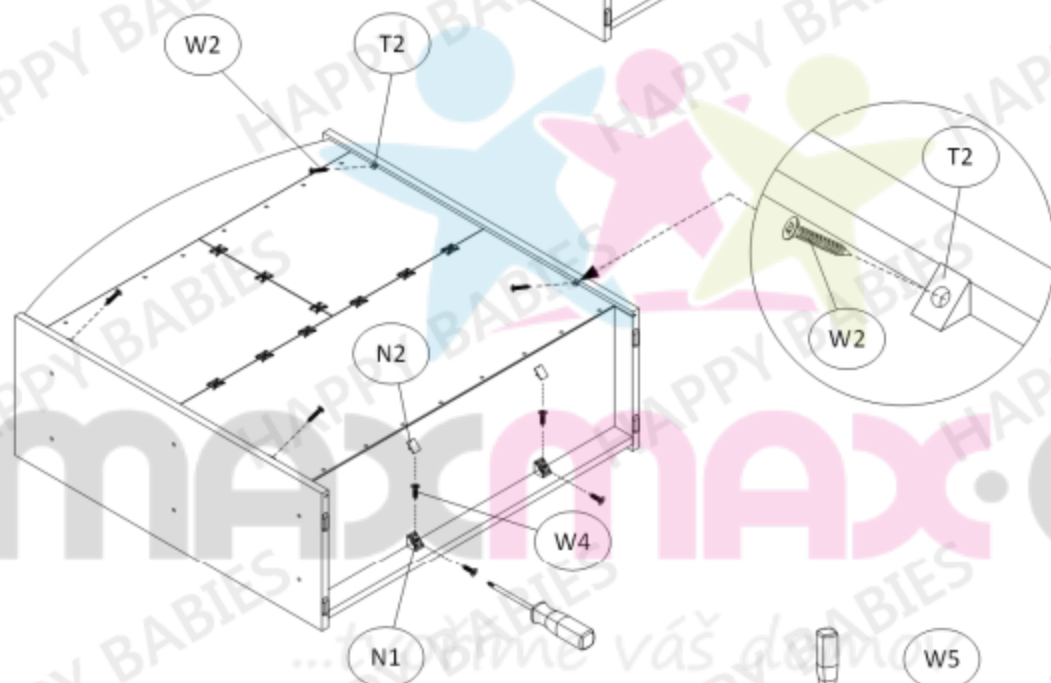
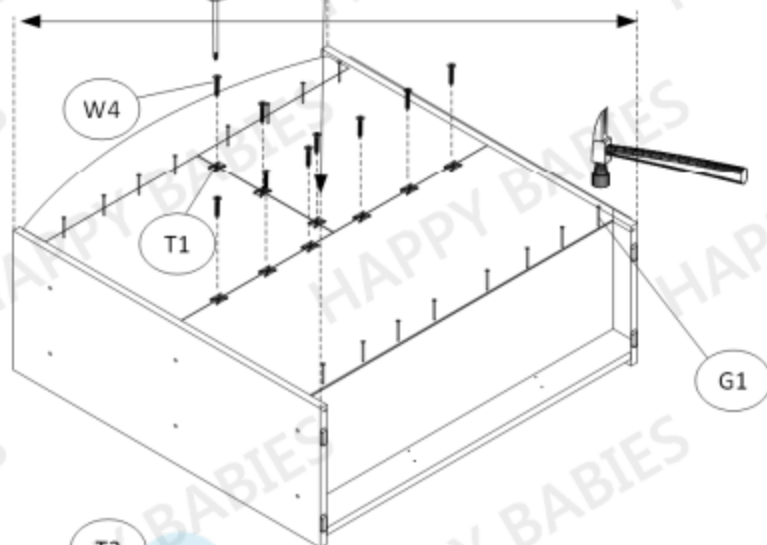

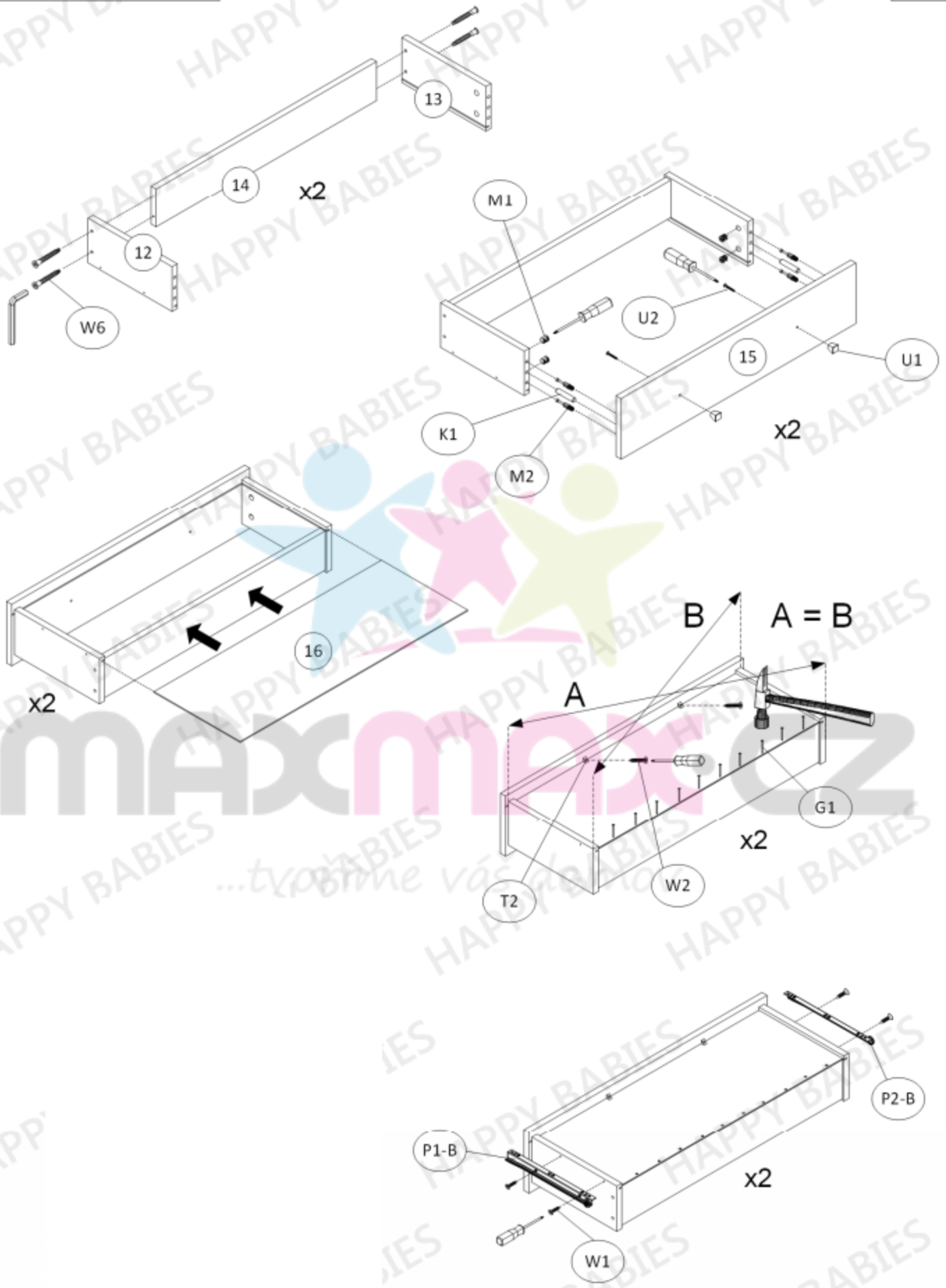

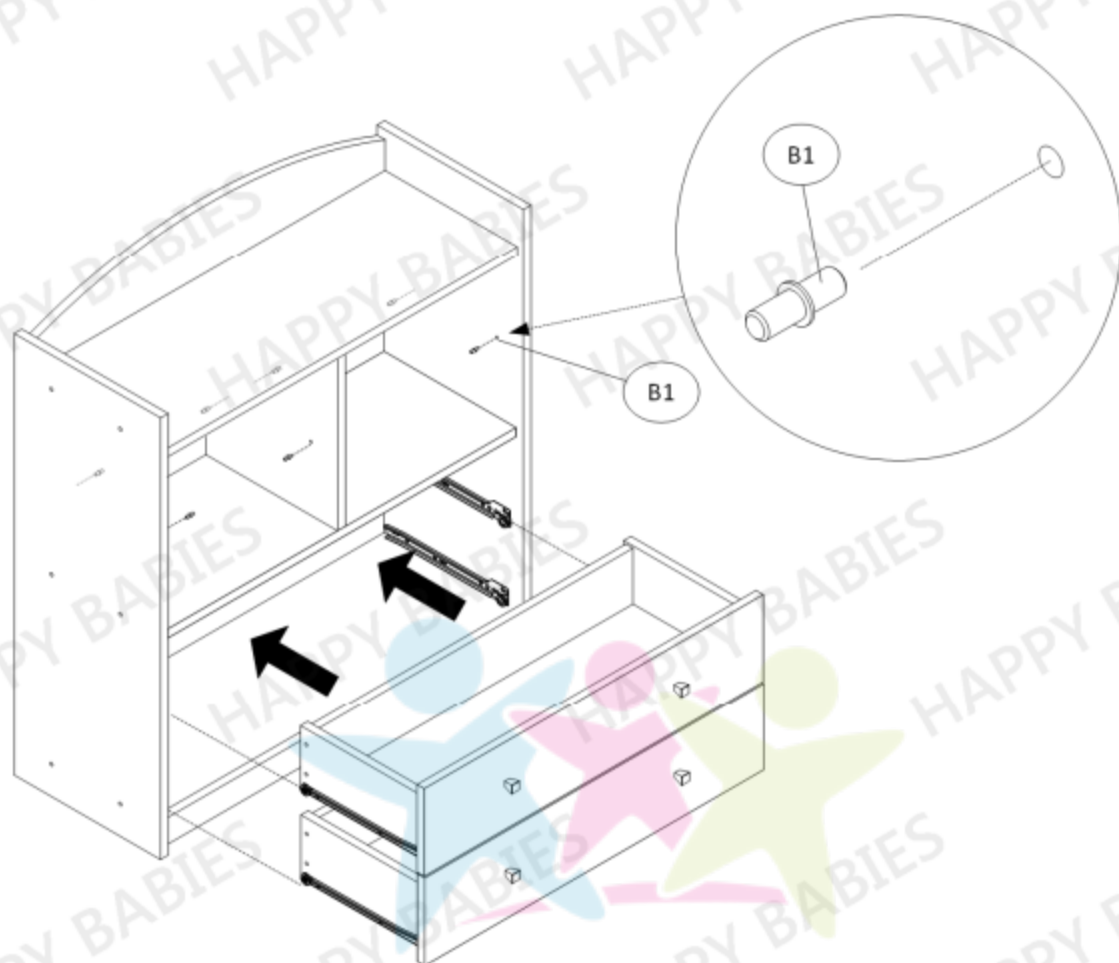

MAXmax.CZ

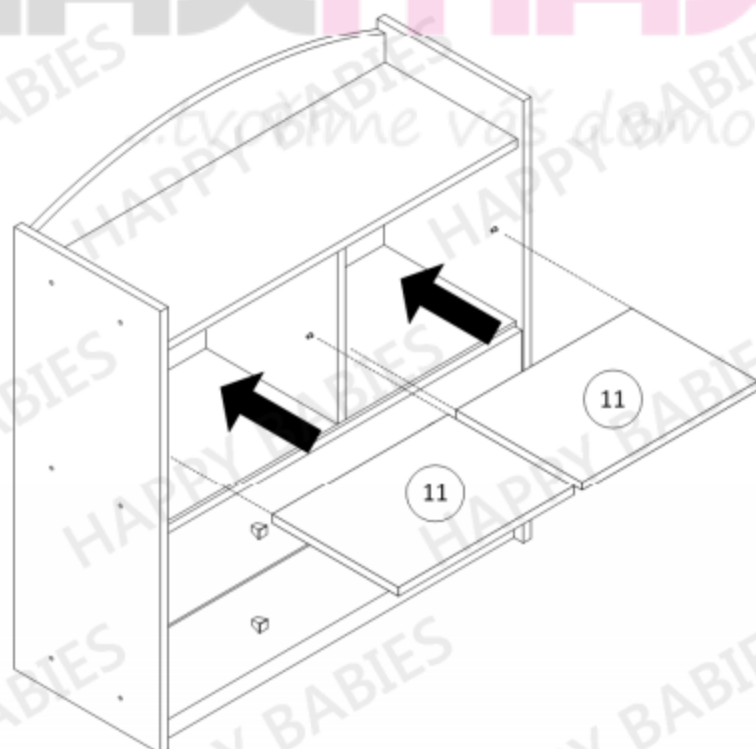

Seřízení výsuvných lišt

1. Uvolněte šrouby.

2. Posuňte lištu nahoru
nebo dolů na požadovanou
vzdálenost.

3. Utáhněte dříve uvolněné šrouby.

4. Posuňte zásuvku a zkontrolujte jestli
jsou výsuvné lišty ve správné poloze.

5. Utáhněte zbylé šrouby.

Pokud to bude nezbytné, kroky zopakujte.