



























## HAPPY RW04

### Montážní návod

#### Příslušenství

<b>W1</b>  ø3 × 16	<b>W2</b>  ø3 × 20	<b>W3</b>  ø3,5 × 16	<b>W4</b>  ø4 × 16	<b>W5</b>  ø4 × 35	<b>W6</b>  ø6.3 × 50	<b>G1</b> 	
4 ks	7 ks	10 ks	2 ks	1 ks	16 ks	16 ks	
<b>M1</b> 	<b>M2</b> 	<b>K1</b>  ø8 × 35	<b>S1</b> 	<b>T2</b> 	<b>N1</b> 	<b>N2</b> 	
4 ks	4 ks	6 ks	4 ks	7 ks	1 ks	1 ks	
<b>U1</b> 	<b>U2</b>  ø4 × 30	<b>B1</b> 	<b>P1-A</b> 	<b>P1-B</b> 	<b>P2-A</b> 	<b>P1-B</b> 	
1 ks	1 ks	12 ks	1 ks	1 ks	1 ks	1 ks	
<b>TZ1</b> 	<b>ZM1</b> 	<b>ZW1</b> 					
1 ks	4 ks	16 ks					

#### Nářadí



**K montáži je zapotřebí přítomnost dvou osob.**

**VELMI DŮLEŽITÉ!**  
**PROSÍM, ČTĚTE POZORNĚ.**  
**UCHOVEJTE PRO DALŠÍ POUŽITÍ.**



## **UŽIVATELSKÁ PŘÍRUČKA**

**1.**

Balení obsahuje malé části, a proto jej udržujte mimo dosah dětí.

**2.**

Všechny spoje musí být řádně utaženy a žádná párová součástka nesmí být ztracena.

**3.**

Pokud je některá ze součástí poškozena nebo chybí, regál nepoužívejte.

**4.**

Používejte pouze součástky dodány výrobcem.

**5.**

Neumisťujte regál poblíž otevřenému ohni nebo dalším zdrojům tepla jakými jsou elektrické nebo plynové radiátory atd. Mohl by být způsoben požár.

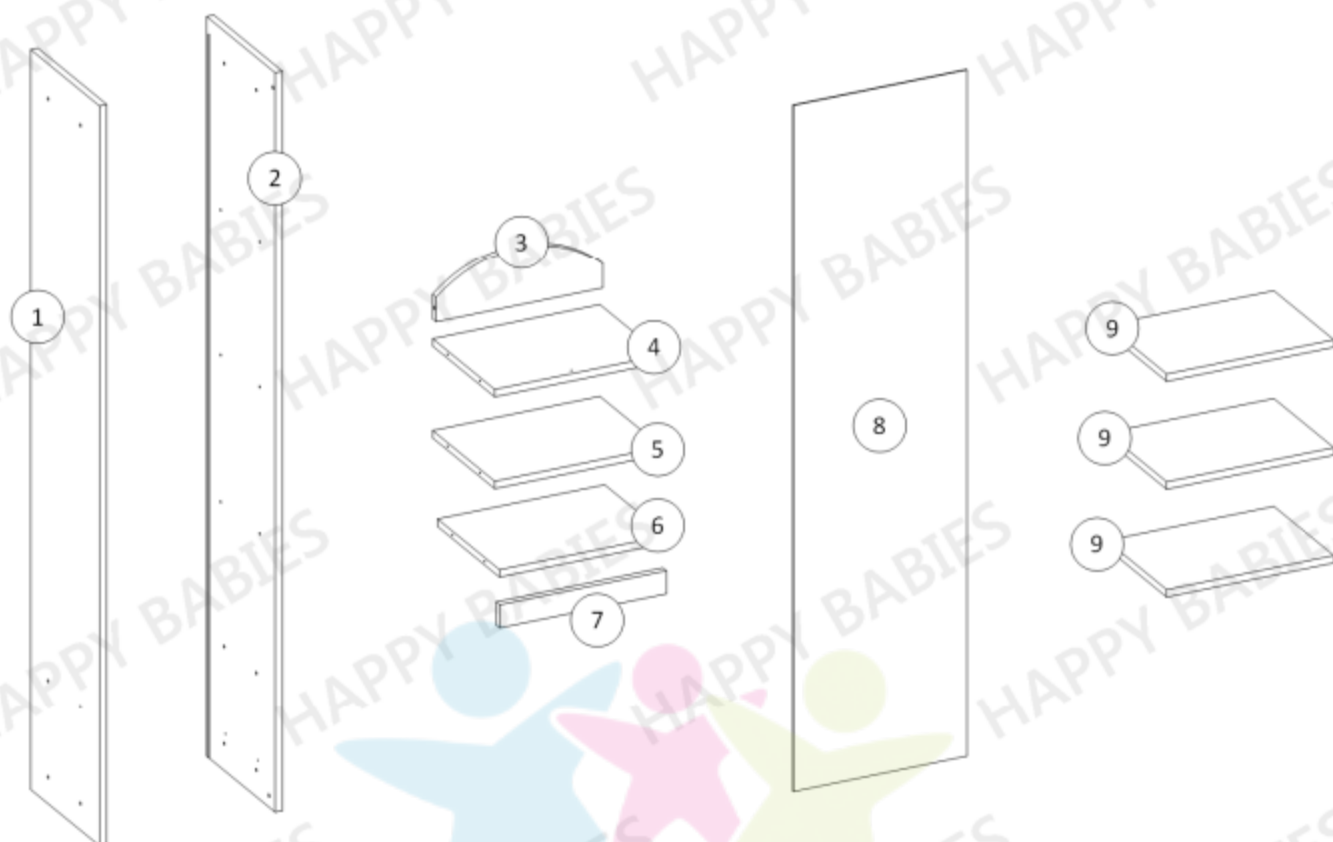

Balení 1/1		
Součástka číslo:	Rozměry (mm):	Množství:
1	1800 x 340 x 18	1
2	1800 x 340 x 18	1
3	414 x 140 x 18	1
4	414 x 307 x 18	1
5	414 x 307 x 18	1
6	414 x 307 x 18	1
7	414 x 56 x 18	1
8	431 x 1674 x 3	1
9	414 x 297 x 18	3
10	300 x 202 x 18	1
11	300 x 202 x 18	1
12	353 x 184 x 18	1
13	410 x 252 x 18	1
14	371 x 304 x 3	1

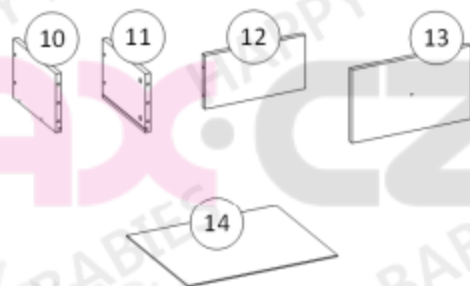

**Před tím, než začnete nábytek sestavovat, zkontrolujte, že balení obsahuje všechny součástky ze seznamu na této straně (strana 3). Dále zkontrolujte, že žádná z těchto součástí není poškozena.**

**Pokud některá ze součástí chybí nebo je poškozena, kontaktujte nás. Na škody způsobené po sestavení nebude brán ohled.**

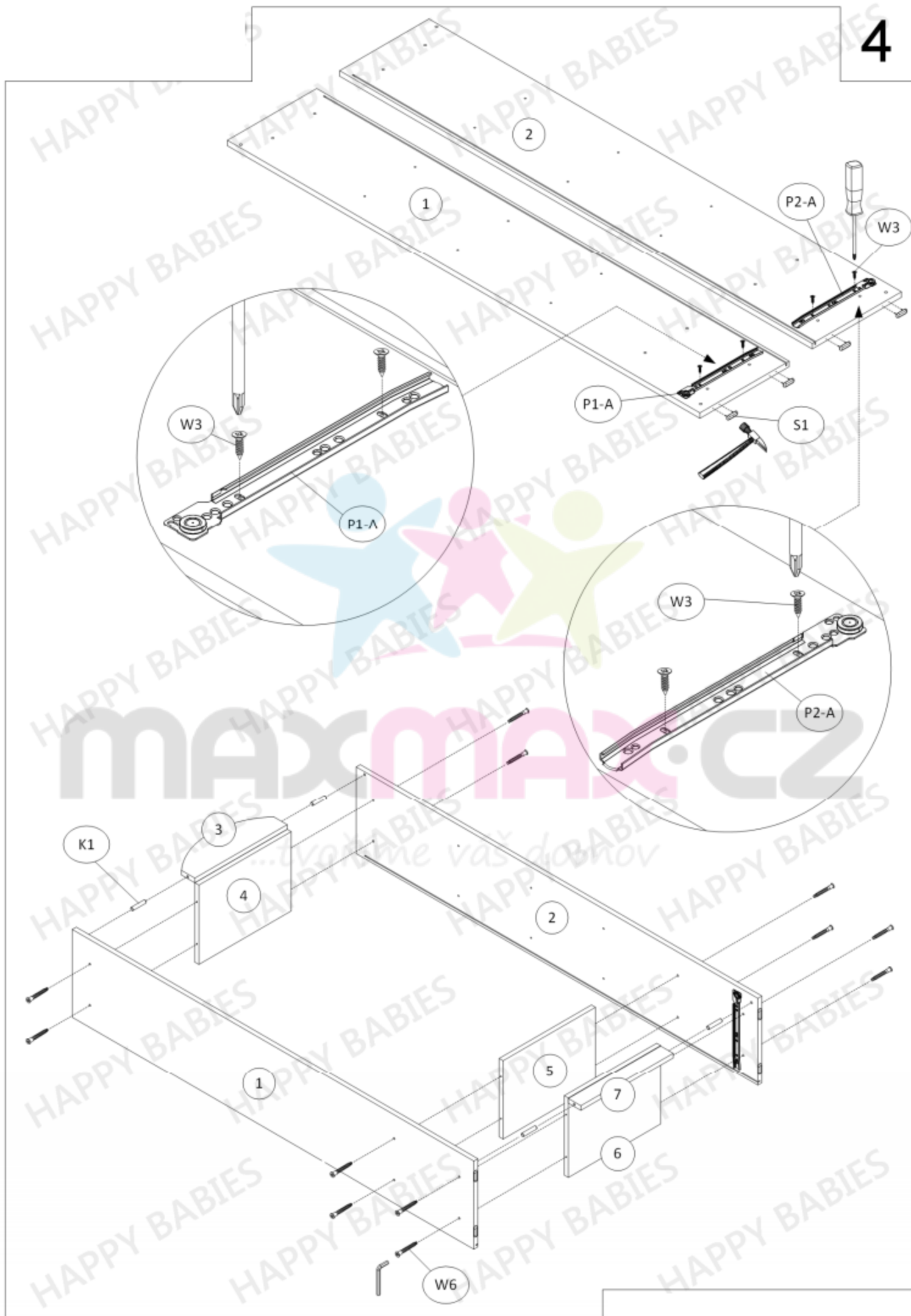

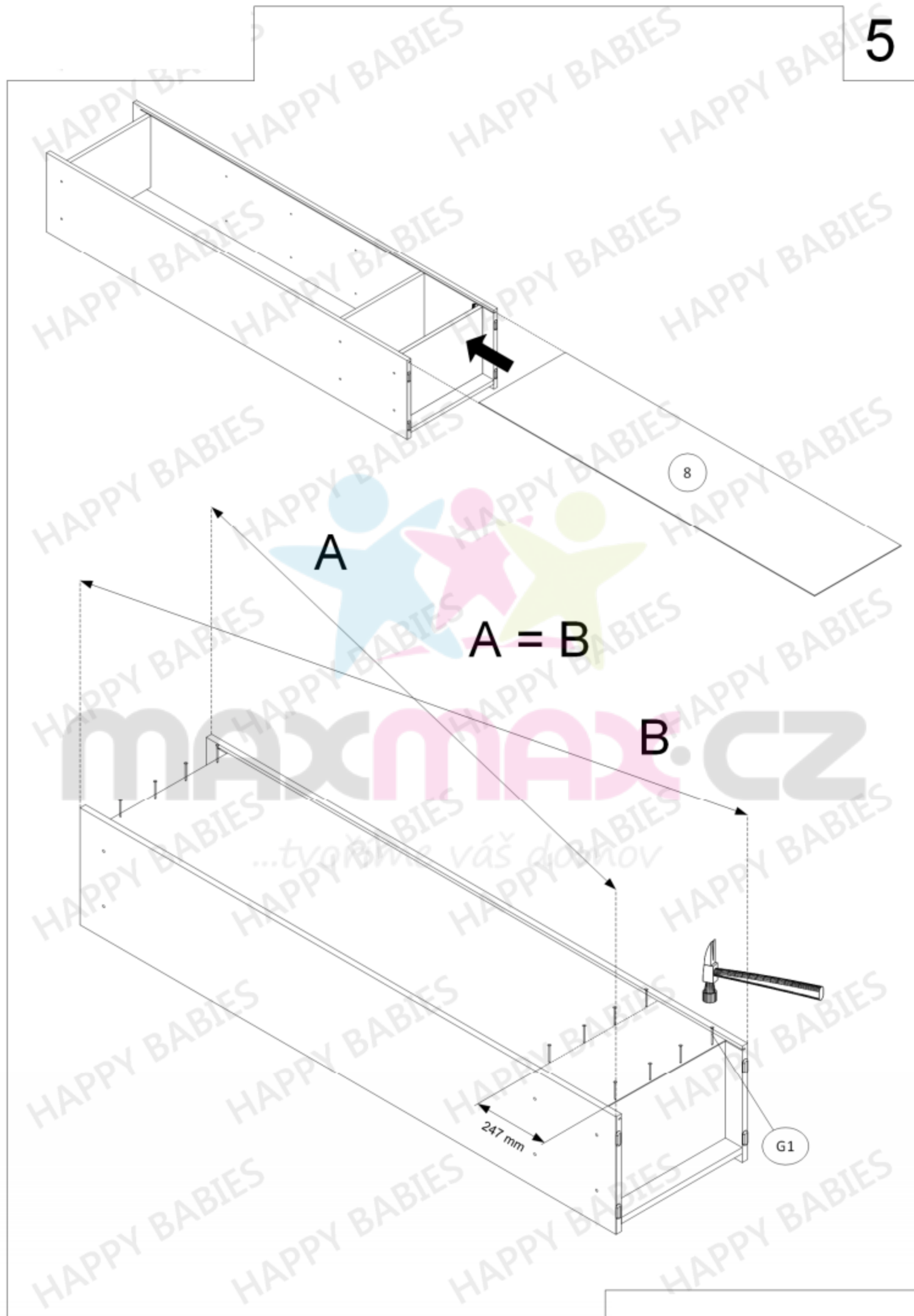

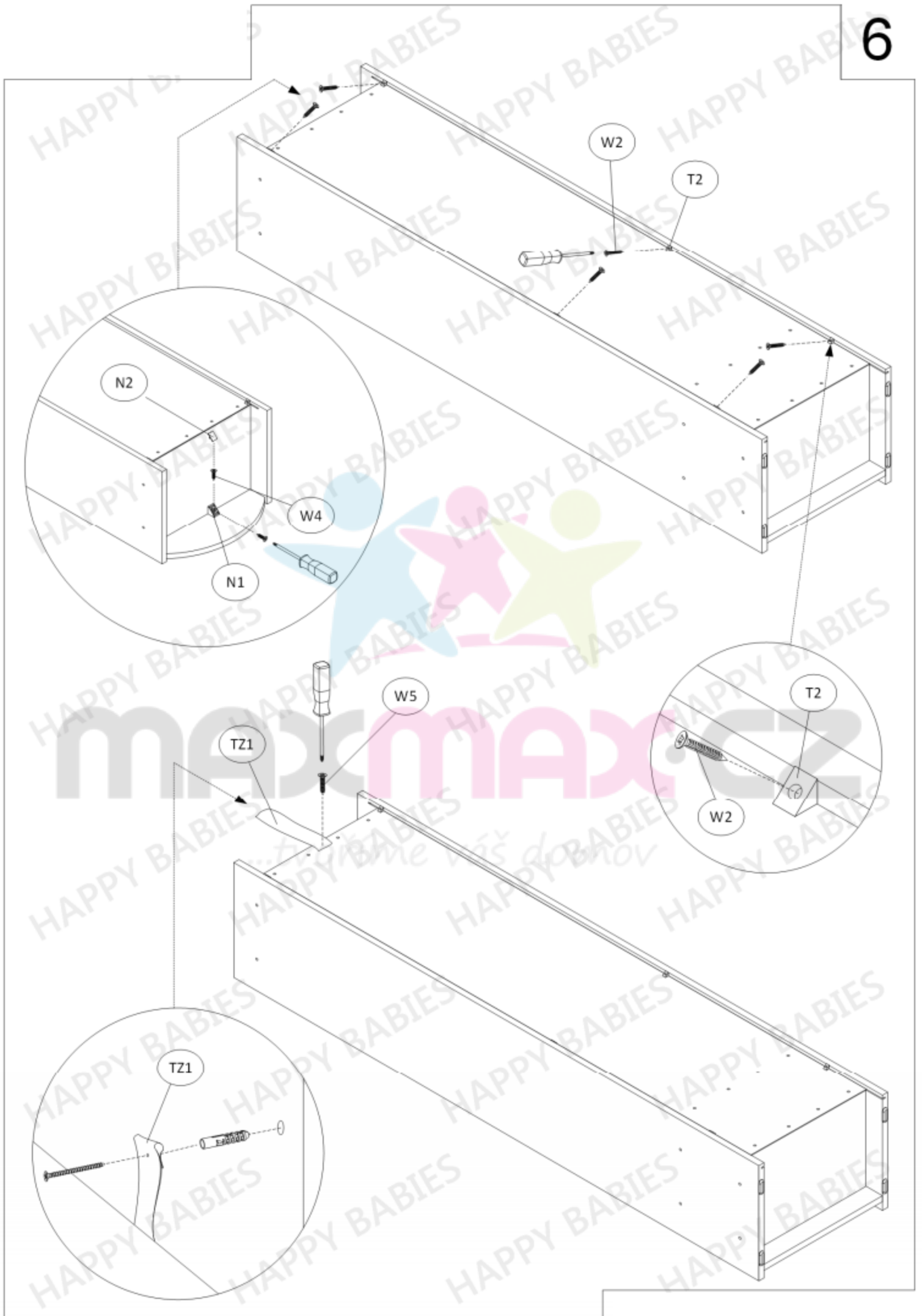

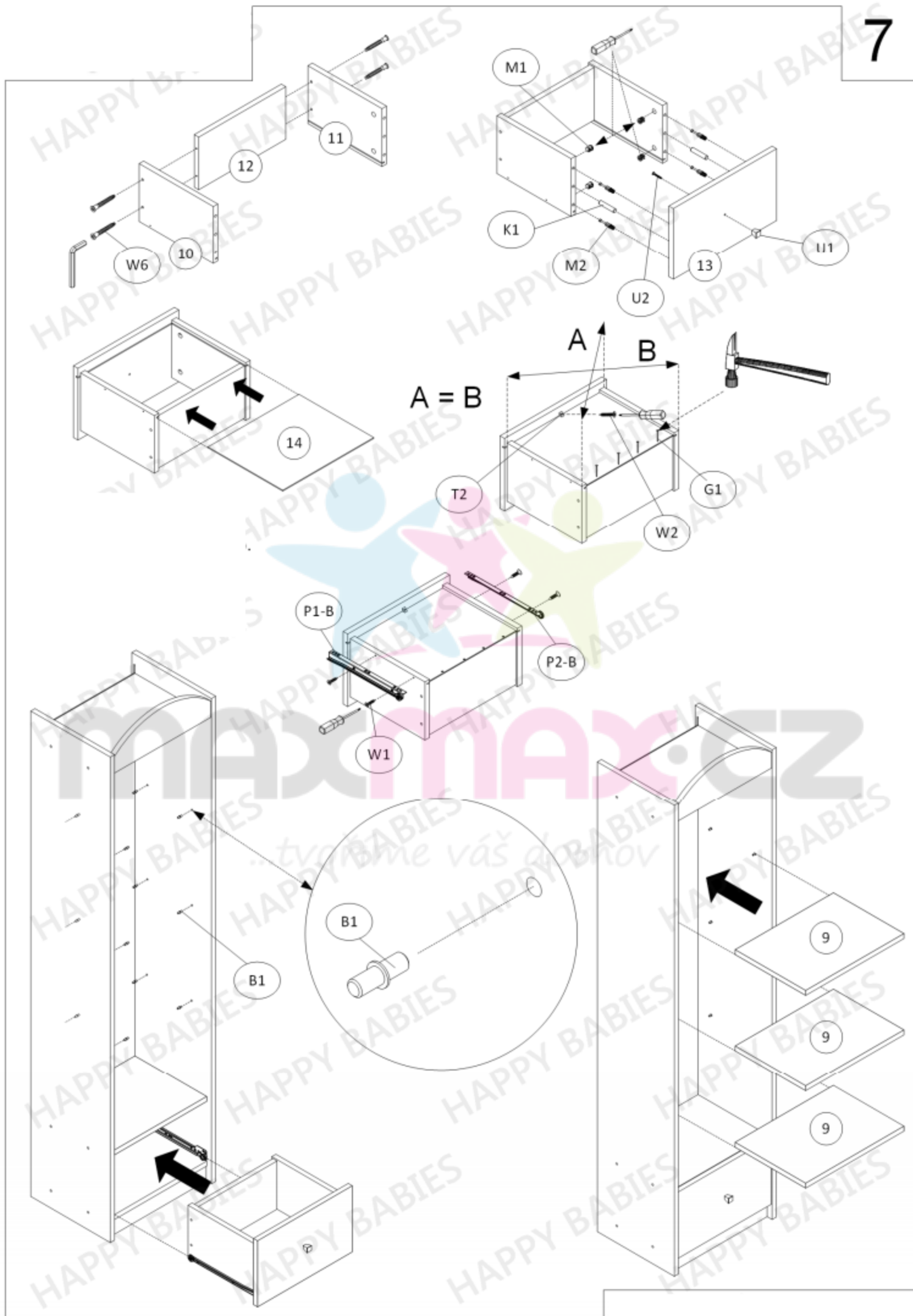

## Seřízení výsuvných lišt

1. Uvolněte šrouby.

2. Posuňte lištu nahoru  
nebo dolů na požadovanou  
vzdálenost.

3. Utáhněte dříve uvolněné šrouby.

4. Posuňte zásuvku a zkontrolujte, jestli  
jsou výsuvné lišty ve správné poloze.

5. Utáhněte zbylé šrouby.

Pokud to bude nezbytné, kroky zopakujte.